

ESD Protection Zener Diode

General Description

SDZ6V2AD in very small SOD-323 SMD plastic package designed to protect one data line from the damage caused by Electro Static Discharge (ESD) and other transients.

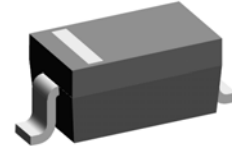

SOD-323



Features and Benefits

- Protection one I/O or power line
- Transient protection for data lines to **IEC 61000-4-2 (ESD)**
Air discharge mode: $\pm 15\text{kV}$, Contact discharge mode: $\pm 8\text{kV}$
- Small package for use in portable equipment
- Full lead(Pb)-free device and RoHS compliant
- Available in "Green" device

Applications

- ESD protection

Ordering Information

Part Number	Marking Code	Package	Packaging
SDZ6V2AD	T2 □	SOD-323	Tape & Reel

Marking Information

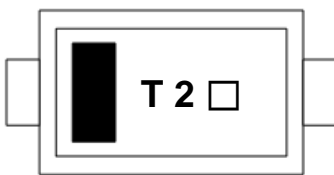

- T 2= Specific Device Code
- = Year & Week Code Marking
- = Color band denote cathode

Pinning Information

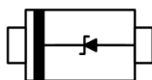
Pin	Description	Simplified Outline	Graphic Symbol
1	Cathode		
2	Anode		

Absolute Maximum Ratings ($T_{amb}=25^{\circ}\text{C}$, Unless otherwise specified)

Characteristic	Symbol	Ratings	Unit
Power dissipation ¹⁾	P_D	200	mW
Operating junction temperature	T_J	150	$^{\circ}\text{C}$
Storage temperature range	T_{stg}	-55 $^{\circ}\text{C}$ to +150 $^{\circ}\text{C}$	$^{\circ}\text{C}$

¹⁾ Device mounted on FR-4 board with recommended pad layout.

Thermal Characteristics ($T_{amb}=25^{\circ}\text{C}$, Unless otherwise specified)

Characteristic	Symbol	Ratings	Unit
Thermal resistance, junction to ambient ¹⁾	$R_{th(j-a)}$	625	$^{\circ}\text{C}/\text{W}$

¹⁾ Device mounted on FR-4 board with recommended pad layout.

Electrical Characteristics ($T_{amb}=25^{\circ}\text{C}$, Unless otherwise specified)

Characteristic	Symbol	Test Condition	Min.	Typ.	Max.	Unit
Zener voltage	V_Z	$I_Z=5\text{mA}$	5.7	-	6.7	V
Reverse current	I_R	$V_R=3\text{V}$	-	-	2	μA
Total capacitance	C_T	$V_R=0\text{V}$, $f=1\text{MHz}$		20		pF

Rating and Characteristic Curves

Fig. 1) Typical Zener Characteristics

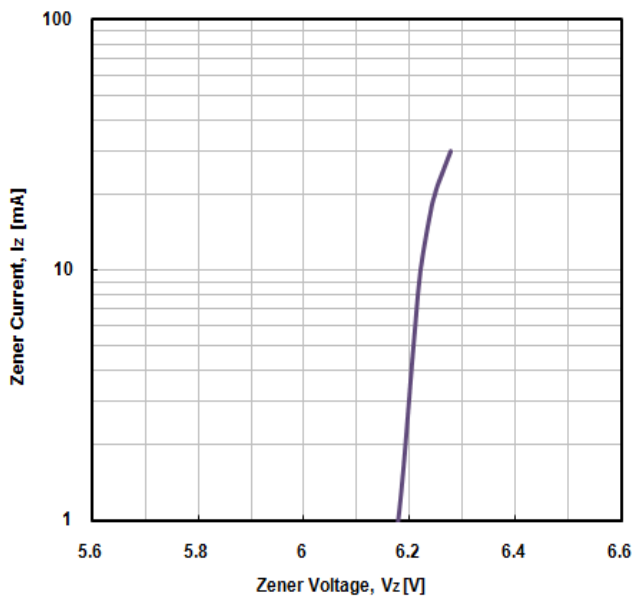

Fig. 2) Power Dissipation vs. Ambient Temperature

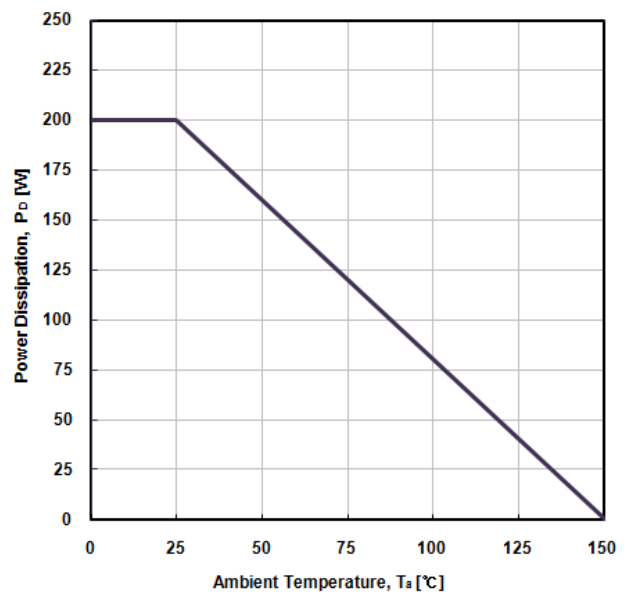
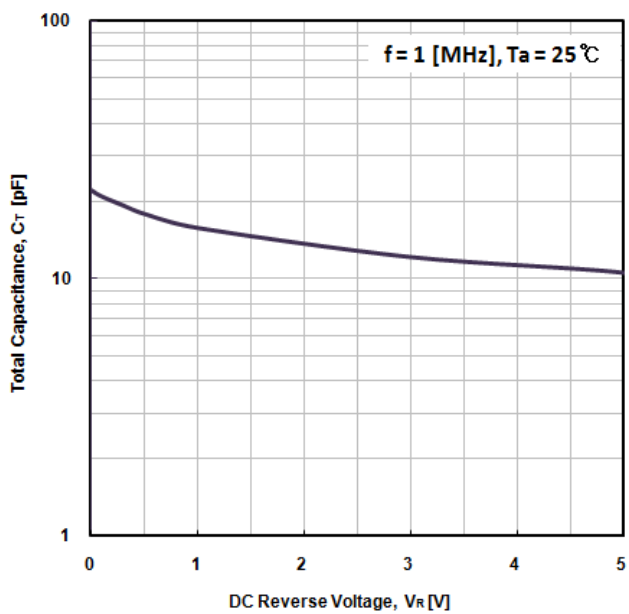
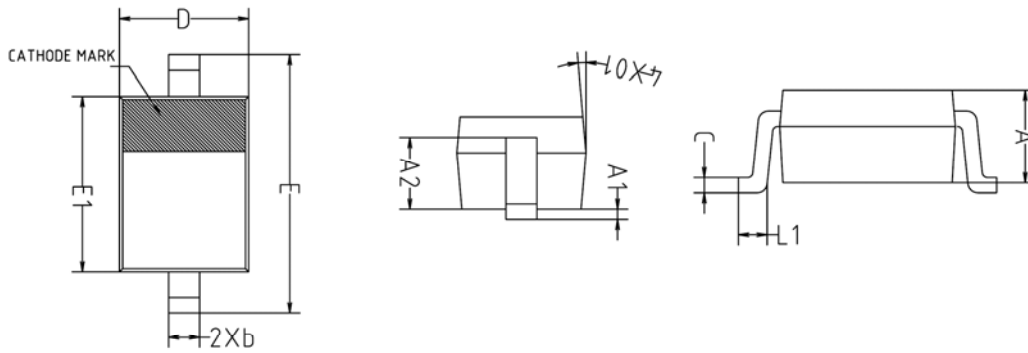

Fig. 3) Typical Capacitance Characteristics



Package Outline Dimensions



SYMBOL	MILLIMETERS			NOTE
	MINIMUM	NOMINAL	MAXIMUM	
A	0.850	-	0.950	
A1	0.000	-	0.100	
A2	0.650	0.700	0.750	
b	0.250	0.300	0.350	
c	0.110	0.150	0.190	
D	1.200	1.250	1.300	
E	2.400	2.500	2.600	
E1	1.650	1.700	1.750	
L1	0.200	-	0.300	
∅2	5° REF			

※ Recommend PCB solder land (Unit : mm)

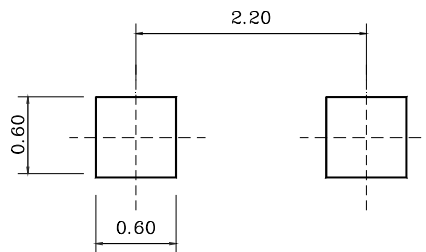

The AUK Corp. products are intended for the use as components in general electronic equipment (Office and communication equipment, measuring equipment, home appliance, etc.).

Please make sure that you consult with us before you use these AUK Corp. products in equipments which require high quality and / or reliability, and in equipments which could have major impact to the welfare of human life(atomic energy control, airplane, spaceship, transportation, combustion control, all types of safety device, etc.). AUK Corp. cannot accept liability to any damage which may occur in case these AUK Corp. products were used in the mentioned equipments without prior consultation with AUK Corp..

Specifications mentioned in this publication are subject to change without notice.