

Small Signal Zener Diode

Features and Benefits

- Silicon planar power Zener diode
- Low Zener impedance and low leakage current
- High reliability and very high stability
- “Green” device and RoHS compliant device



SOD-123



Applications

- Constant voltage regulation
- Reference voltage application

Ordering Information

Part Number	Marking Code	Package	Packaging
SDZ12VG	12V □	SOD-123	Tape & Reel

Marking Information

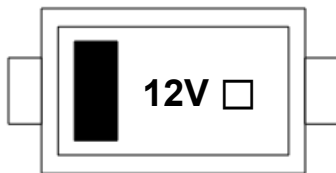

12V = Specific Device Code

□ = Year & Week Code Marking

■ = Color band denote cathode

Pinning Information

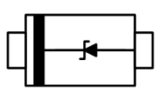
Pin	Description	Simplified Outline	Graphic Symbol
1	Cathode		
2	Anode		

Absolute Maximum Ratings (T_{amb}=25°C, Unless otherwise specified)

Characteristic	Symbol	Ratings	Unit
Power dissipation ¹⁾	P _D	500	mW
Operating junction temperature	T _J	150	°C
Storage temperature range	T _{stg}	-55°C to +150°C	°C

¹⁾ Device mounted on FR4 PCB, Single Side Copper, Mounting Pad for 2.5x2.5 mm.

Electrical Characteristics (T_{amb}=25°C, Unless otherwise specified)

Device	Marking Info.	V _Z			Z _{ZT}		Z _{ZK}		I _R	
		@ I _{ZT}	Min	Max	Max	@ I _{ZT}	Max	@ I _{ZK}	Max	@ V _R
		mA	V		Ω	mA	Ω	mA	μA	V
SDZ3V0G	3V0	20	2.85	3.15	29	20	1600	0.25	50	1.0
SDZ3V3G	3V3	20	3.14	3.50	28	20	1600	1.0	25	1.0
SDZ3V6G	3V6	20	3.42	3.78	24	20	1700	0.25	15	1.0
SDZ3V9G	3V9	20	3.71	4.10	23	20	1900	0.25	5	1.0
SDZ5V1G	5V1	20	4.94	5.20	17	20	1600	0.25	5	1.5
SDZ5V6G	5V6	20	5.45	5.73	40	20	500	1.0	5	2.5
SDZ6V2G	6V2	20	6.08	6.35	7	20	1600	0.25	5	4.0
SDZ6V8G	6V8	20	6.66	7.01	15	20	75	1.0	1.8	4.0
SDZ7V5G	7V5	20	7.29	7.67	6	20	500	0.25	3	6.0
SDZ8V2G	8V2	20	8.04	8.40	15	20	120	1.0	0.7	5.0
SDZ9V1G	9V1	20	8.85	9.28	10	20	600	0.25	3	7.0
SDZ12VG	12V	10	11.44	12.24	25	10	150	1.0	0.2	9.0
SDZ13VG	13V	10	12.70	13.30	30	10	160	1.0	0.2	10.0
SDZ15VG	15V	8.5	14.25	15.75	16	8.5	600	0.25	0.1	11.0
SDZ16VG	16V	10	15.64	16.38	40	10	188	1.0	0.2	12.0
SDZ18VG	18V	7.0	16.80	19.10	21	7.0	600	0.25	0.1	14.0
SDZ20VG	20V	6.2	19.00	21.00	25	6.2	600	0.25	0.1	15.0
SDZ24VG	24V	5.2	22.80	25.20	33	5.2	600	0.25	0.1	18.0
SDZ28VG	28V	4.5	26.60	29.40	44	4.5	600	0.25	0.1	21.0
SDZ30VG	30V	4.2	28.50	31.50	49	4.2	600	0.25	0.1	23.0
SDZ33VG	33V	3.8	31.35	34.65	58	3.8	700	0.25	0.1	25.0
SDZ36VG	36V	3.4	34.2	37.8	70	3.4	700	0.25	0.1	27.0

Rating and Characteristic Curves

Fig. 1) Typical Zener Characteristics

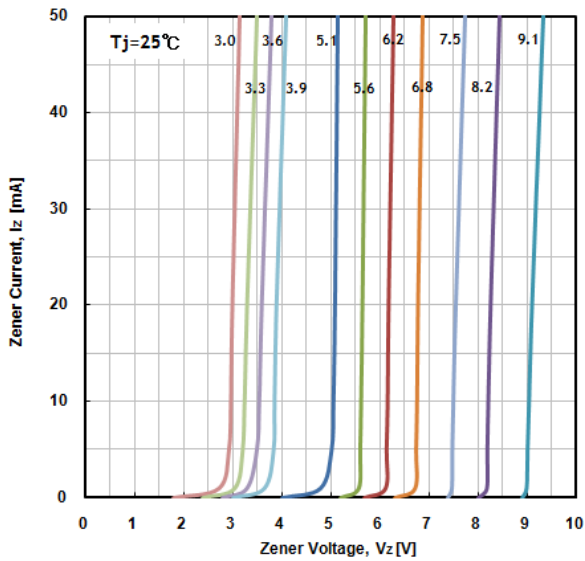

Fig. 2) Typical Zener Characteristics

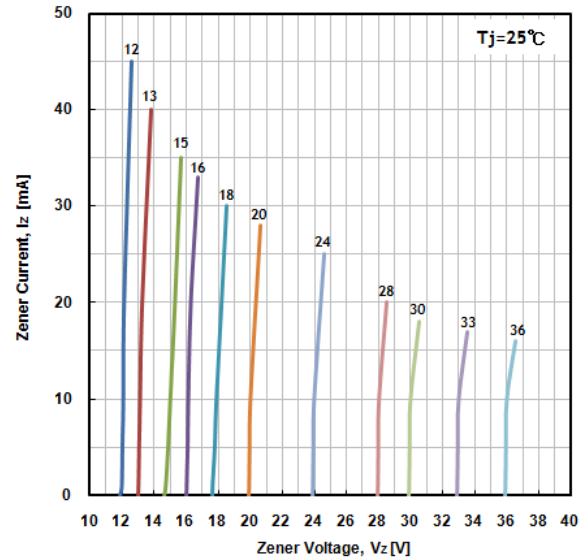

Fig. 3) Typical Forward Characteristics

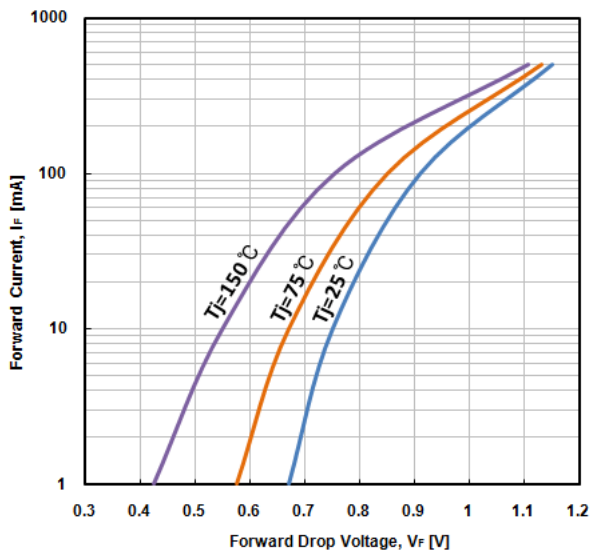

Fig. 4) Power Dissipation vs. Ambient Temperature

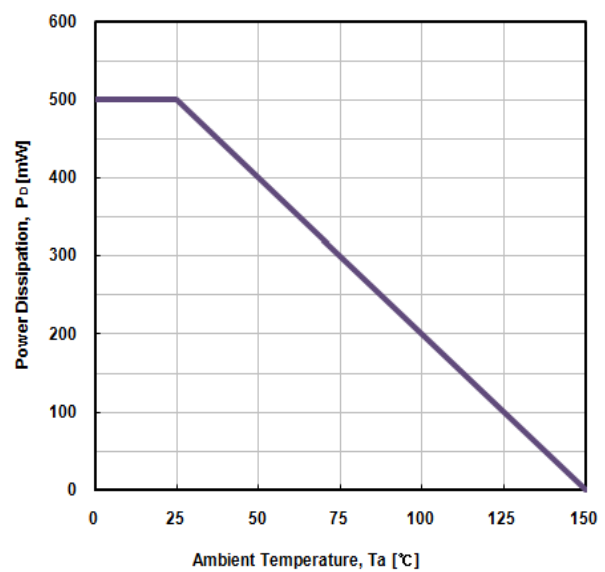
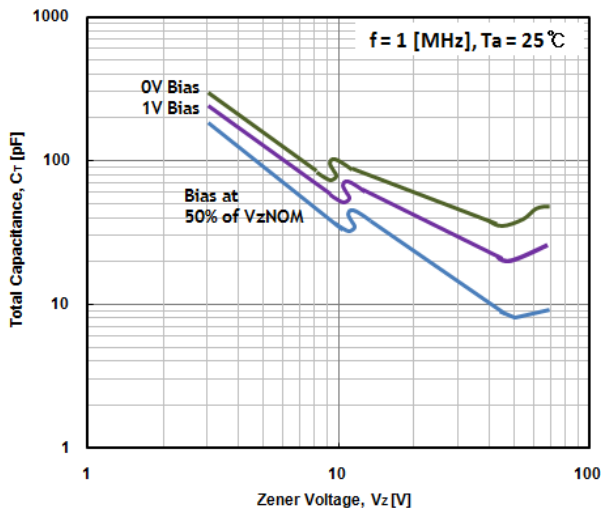
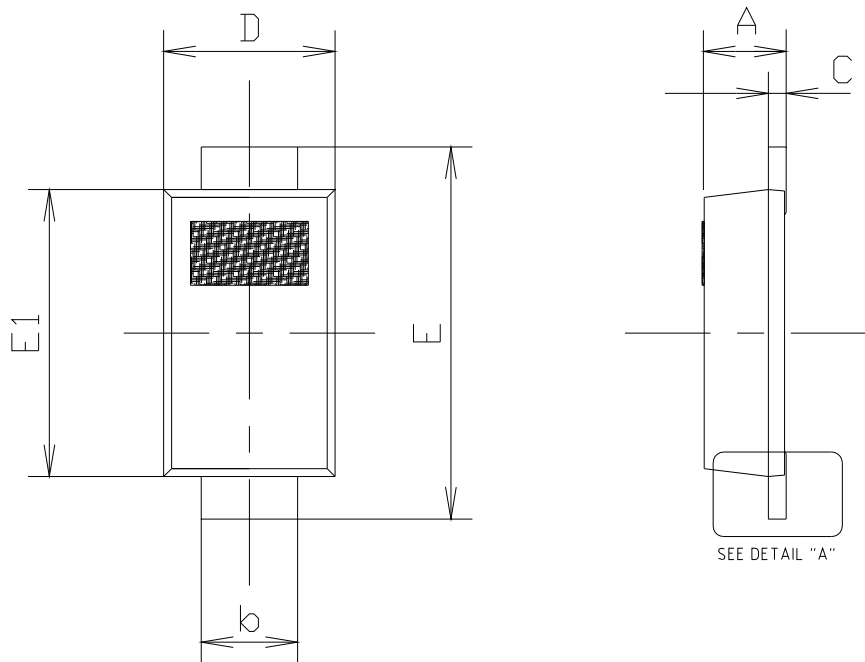

Fig. 5) Typical Capacitance Characteristics



Package Outline Dimensions



SYMBOL	MILLIMETERS			NOTE
	MINIMUM	NOMINAL	MAXIMUM	
A	0.70	0.85	1.00	
b	0.50	0.75	1.00	
c	0.12	0.16	0.20	
D	1.50	1.60	1.70	
E	3.30	3.50	3.70	
E1	2.50	2.65	2.80	

※ Recommend PCB solder land (Unit : mm)

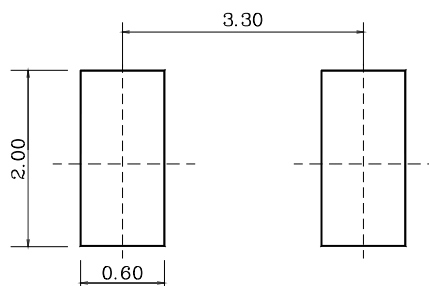

The AUK Corp. products are intended for the use as components in general electronic equipment (Office and communication equipment, measuring equipment, home appliance, etc.).

Please make sure that you consult with us before you use these AUK Corp. products in equipments which require high quality and / or reliability, and in equipments which could have major impact to the welfare of human life(atomic energy control, airplane, spaceship, transportation, combustion control, all types of safety device, etc.). AUK Corp. cannot accept liability to any damage which may occur in case these AUK Corp. products were used in the mentioned equipments without prior consultation with AUK Corp..

Specifications mentioned in this publication are subject to change without notice.