

High Voltage Switching Diode

General Description

Dual general-purpose switching diodes, fabricated in planar technology, and packaged in small SOT-23 surface mounted device (SMD) packages.

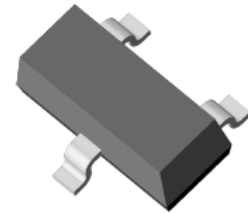

SOT-23

Features and Benefits

- Silicon epitaxial planar diode
- High switching speed
- Low forward drop voltage and low leakage current
- “Green” device and RoHS compliant device
- Available in full lead (Pb)-free device



Applications

- Ultra high speed switching application

Ordering Information

Part Number	Marking Code	Package	Packaging
SDS21WM	J2M □	SOT-23	Tape & Reel

Marking Information

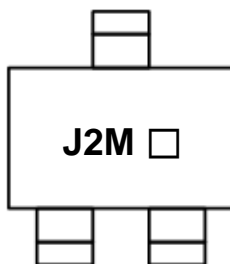

J2M = Specific Device Code

□ = Year & Week Code Marking

Pinning Information

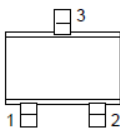
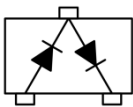
Pin	Description	Simplified Outline	Graphic Symbol
1	Anode (Diode 1)		
2	Cathode (Diode 2)		
3	Cathode (Diode 1), Anode (Diode 2)		

Absolute Maximum Ratings ($T_{amb}=25^{\circ}\text{C}$, Unless otherwise specified)

Characteristic	Symbol	Ratings	Unit
Maximum repetitive peak reverse voltage	V_{RM}	250	V
Continuous reverse voltage	V_R	200	V
Maximum average forward rectified current	I_O	200	mA
Maximum repetitive peak forward current	I_{FM}	400	mA
Non-repetitive peak forward surge current($t=10\text{ms}$)	I_{FSM}	1.7	A
Power dissipation ¹⁾	P_D	250	mW

¹⁾ Device mounted on FR-4 board with recommended pad layout.

Thermal Characteristics ($T_{amb}=25^{\circ}\text{C}$, Unless otherwise specified)

Characteristic	Symbol	Ratings	Unit
Thermal resistance, junction to ambient ¹⁾	$R_{th(j-a)}$	500	$^{\circ}\text{C}/\text{W}$
Operating junction temperature	T_j	150	$^{\circ}\text{C}$
Storage temperature range	T_{stg}	-55 ~ 150	$^{\circ}\text{C}$

¹⁾ Device mounted on FR-4 board with recommended pad layout.

Electrical Characteristics ($T_{amb}=25^{\circ}\text{C}$, Unless otherwise specified)

Characteristic	Symbol	Test Condition	Min.	Typ.	Max.	Unit
Reverse breakdown voltage	V_{BR}	$I_F=100\mu\text{A}$	250	-	-	V
Forward drop voltage ²⁾	V_F	$I_F=100\text{mA}$	-	-	1.0	V
		$I_F=200\text{mA}$	-	-	1.25	V
Reverse leakage current ³⁾	I_R	$V_R=200\text{V}$	-	-	100	nA
		$V_R=200\text{V}, T_a=150^{\circ}\text{C}$	-	-	100	μA
Total capacitance	C_T	$V_R=0\text{V}, f=1\text{MHz}$	-	-	5	pF
Reverse recovery time	t_{rr}	$I_F=I_R=30\text{mA}, I_{rr}=3\text{mA}, R_L=100\Omega$	-	-	50	ns

²⁾ Pulse test: $t_p \leq 380\mu\text{s}$, Duty cycle $\leq 2\%$

³⁾ Pulse test: $t_p \leq 5\text{ms}$, Duty cycle $\leq 2\%$

Rating and Characteristic Curves

Fig. 1) Typical Forward Characteristics

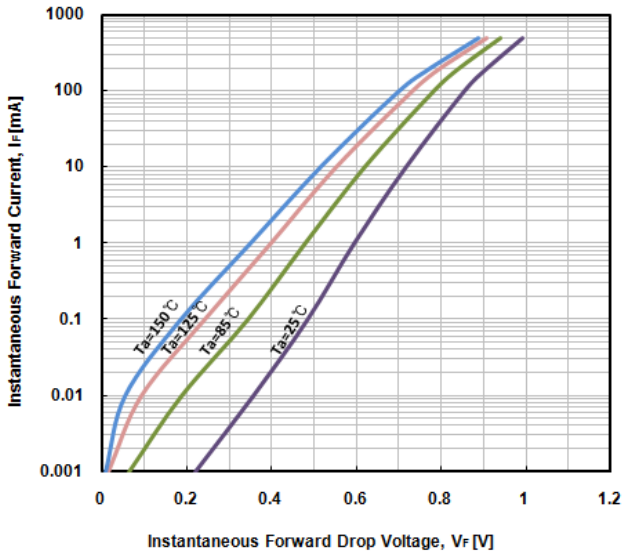

Fig. 2) Typical Reverse Characteristics

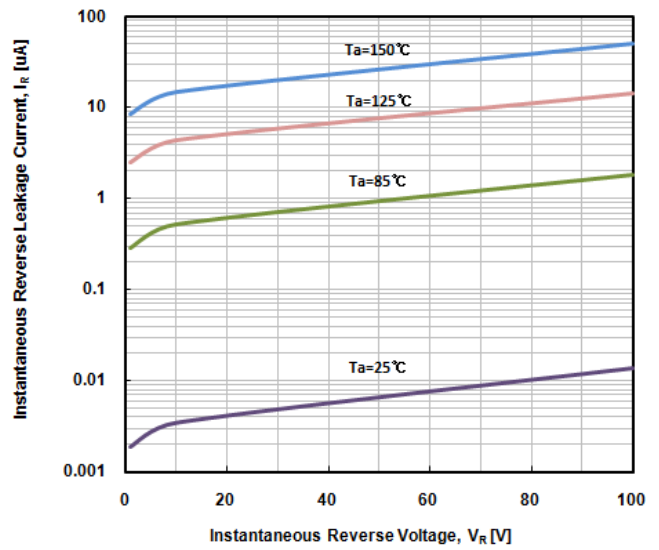

Fig. 3) Typical Total Capacitance Characteristics

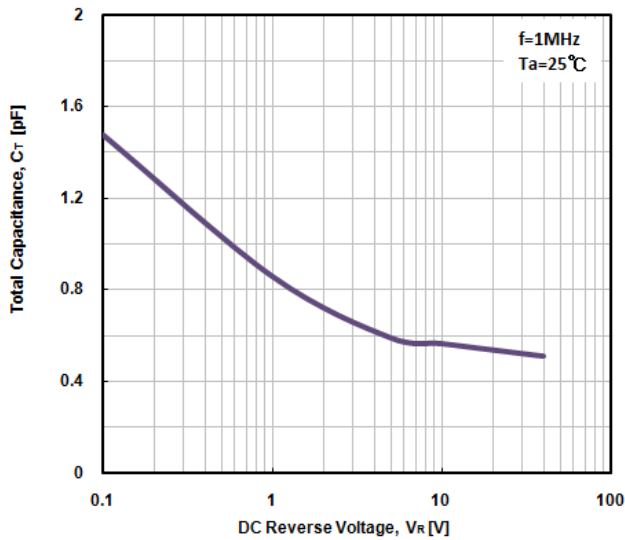

Fig. 4) Power Dissipation vs. Ambient Temperature

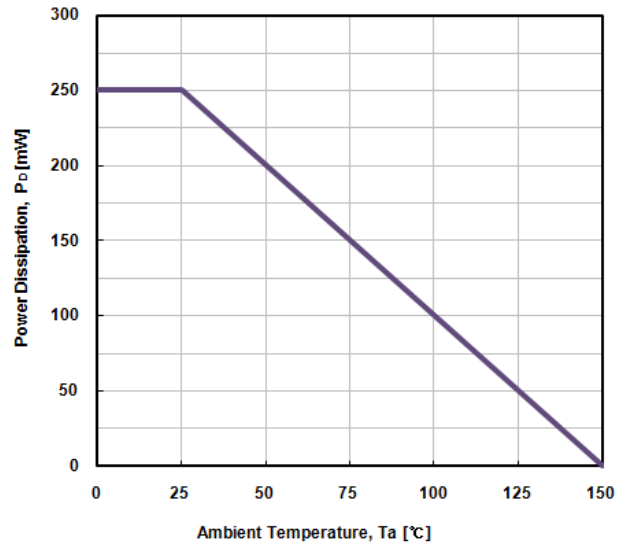
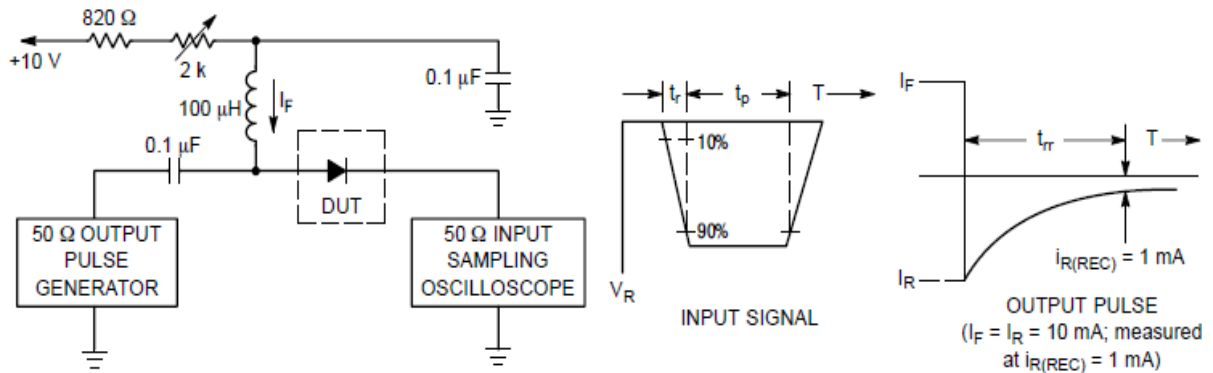
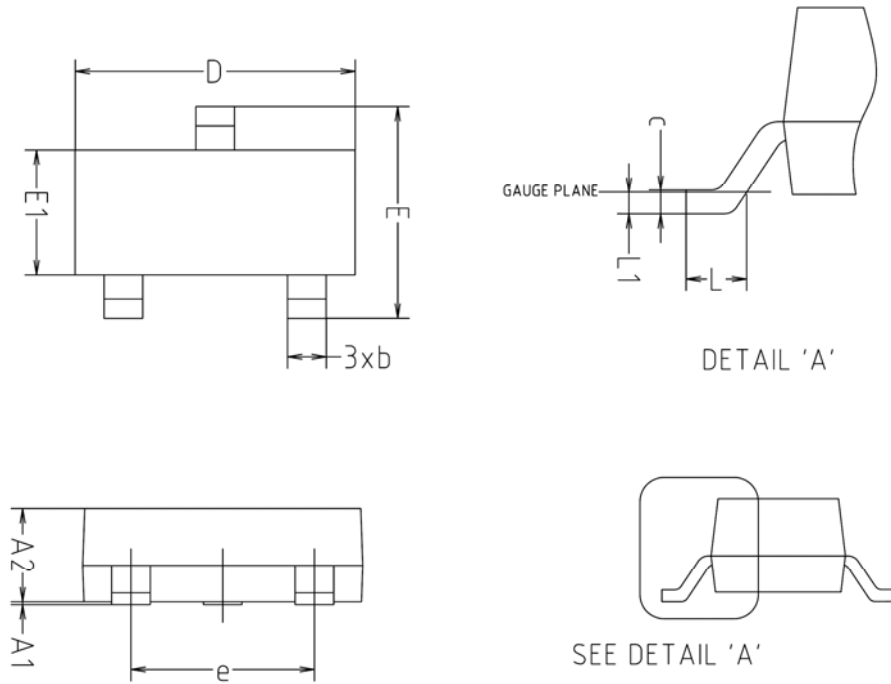

Fig. 5) Reverse recovery time equivalent test circuit



Package Outline Dimensions



SYMBOL	MILLIMETERS			NOTE
	MINIMUM	NOMINAL	MAXIMUM	
A1	0.00	-	0.10	
A2	0.82	-	1.02	
b	0.39	0.42	0.45	
c	0.09	0.12	0.15	
D	2.80	2.90	3.00	
E	2.20	2.40	2.60	
E1	1.20	1.30	1.40	
e	1.90BSC			
L	0.20	-	-	
L1	0.12BSC			

※ Recommend PCB solder land (Unit : mm)

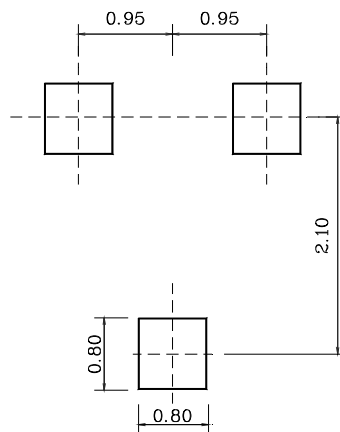

The AUK Corp. products are intended for the use as components in general electronic equipment (Office and communication equipment, measuring equipment, home appliance, etc.).

Please make sure that you consult with us before you use these AUK Corp. products in equipments which require high quality and / or reliability, and in equipments which could have major impact to the welfare of human life(atomic energy control, airplane, spaceship, transportation, combustion control, all types of safety device, etc.). AUK Corp. cannot accept liability to any damage which may occur in case these AUK Corp. products were used in the mentioned equipments without prior consultation with AUK Corp..

Specifications mentioned in this publication are subject to change without notice.