

DUAL COMMON ANODE SCHOTTKY RECTIFIER

Features

- Low forward voltage drop and leakage current
- Low power loss and High efficiency
- High surge capability
- Dual common anode rectifier
- Full lead(Pb)-free component and RoHS compliant device

Applications

- Power supply - Output rectification
- Converter
- Free-wheeling diode
- Reverse battery protection
- Power inverters

Description

The SDB20100PR has two schottky barriers arranged in a common anode configuration. Typical applications are in switching power supplies, converters, free-wheeling diodes, and reverse battery protection.

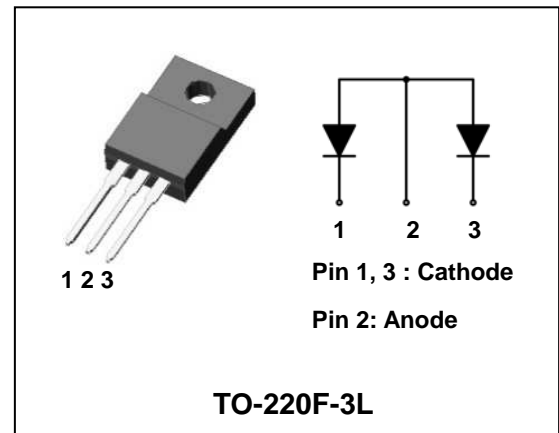

Product Characteristics

$I_{F(AV)}$	2 x 10A
V_{RRM}	100V
V_{FM} at 125°C	0.72V
I_{FSM}	120A

Ordering Information

Device	Marking Code	Package	Packaging
SDB20100PR	B20100PR	TO-220F-3L	Tube

Marking Information

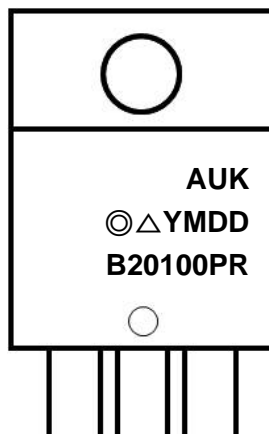

AUK = Manufacture Logo

⊙ = Management Code

Δ = Machine Code

YMDD = Date Code Marking

- . Y = Year Code

- . M = Monthly Code

- . D = Daily Code

B20100PR = Specific Device Code

Absolute Maximum Ratings (Limiting Values)

Characteristic	Symbol	Value	Unit
Maximum repetitive reverse voltage Maximum working peak reverse voltage Maximum DC blocking voltage	V_{RRM} V_{RWM} V_R	100	V
Maximum average forward rectified current	per diode	10	A
	total device	20	
Peak forward surge current 8.3ms single half sine-wave superimposed on rated load per diode	I_{FSM}	120	A
Storage temperature range	T_{stg}	-45°C to +150°C	°C
Maximum operating junction temperature	T_J	150	°C

Thermal Characteristics

Characteristic	Symbol	Value	Unit
Maximum thermal resistance junction to case	per diode	4.0	°C/W
	total device	3.6	

Electrical Characteristics

Characteristic	Symbol	Test Condition	Min.	Typ.	Max.	Unit	
Peak forward voltage drop	$V_{FM}^{(1)}$	$I_{FM} = 10A$	$T_J = 25^\circ C$	-	-	0.85	V
			$T_J = 125^\circ C$	-	-	0.72	V
Reverse leakage current	$I_{RM}^{(1)}$	$V_R = V_{RRM}$	$T_J = 25^\circ C$	-	-	20	uA
			$T_J = 125^\circ C$	-	-	20	mA
Junction capacitance	C_j	$V_R = 10V_{DC}, f=1MHz$	-	150	-	pF	

Note : (1) Pulse test : $t_p \leq 380 \mu s$, Duty cycle $\leq 2\%$

To evaluate the conduction losses use the following equation: $P_F = 0.62 I_{F(AV)} + 0.042 I_{F(RMS)}^2$

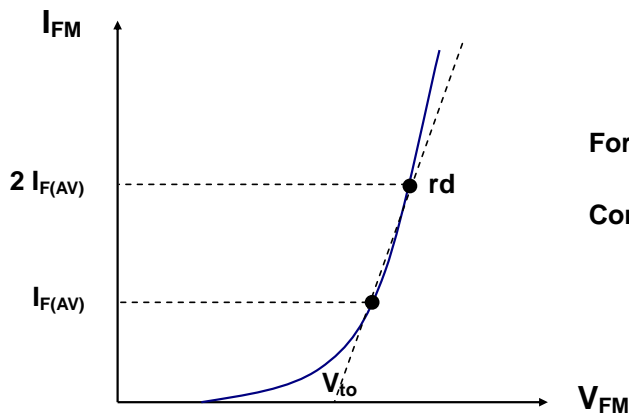

Forward Voltage : $V_{FM} = V_{to} + rd I_{FM}$

Conduction Loss : $P_F = V_{to} I_{F(AV)} + rd I_{F(RMS)}^2$

Rating and Characteristic Curves

Fig. 1) Typical Forward Characteristics (Per Diode)

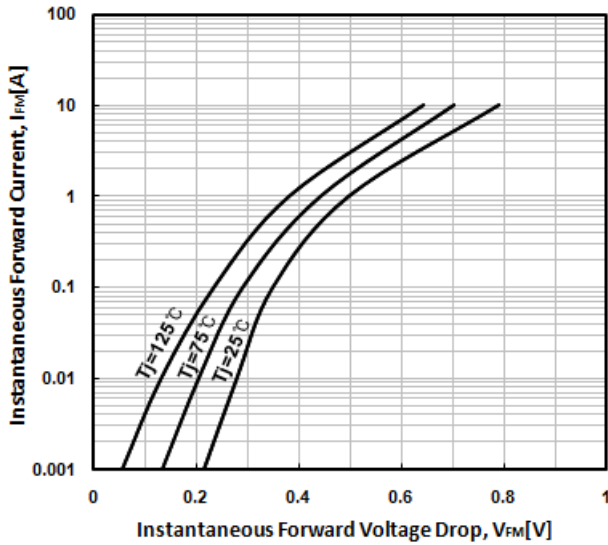

Fig. 2) Typical Reverse Characteristics (Per Diode)

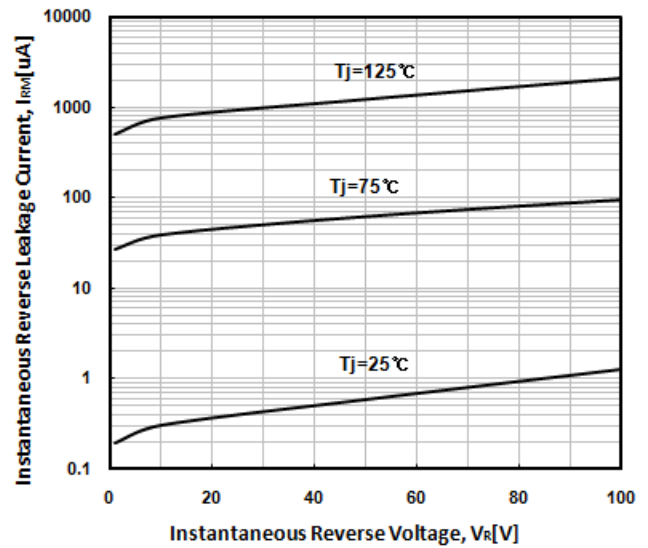

Fig. 3) Maximum Forward Derivative Curve

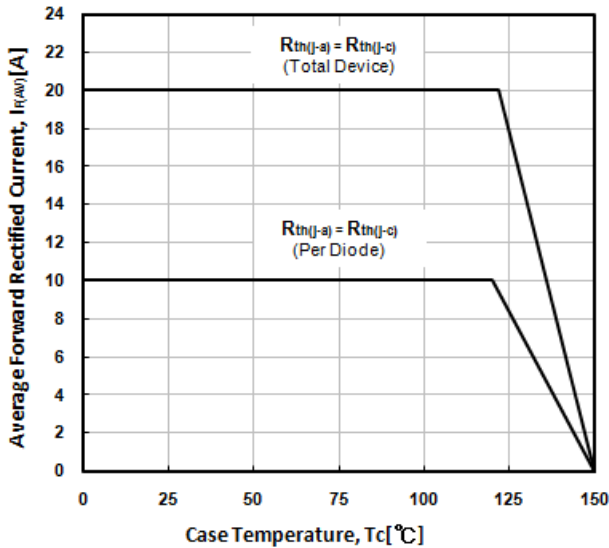

Fig. 4) Forward Power Dissipation (Per Diode)

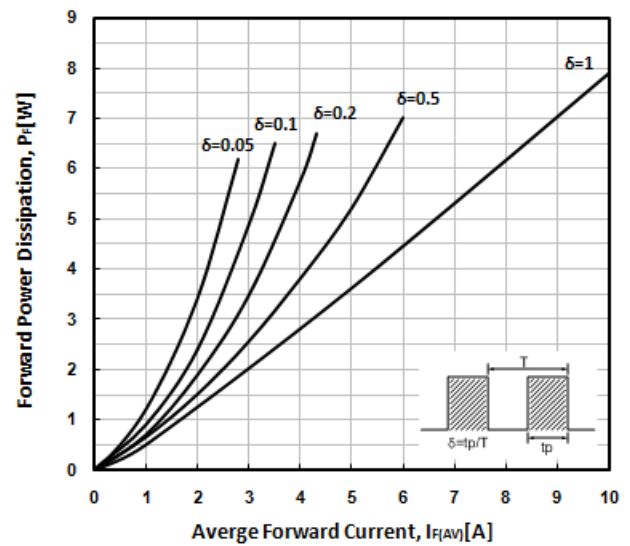

Fig. 5) Maximum Non-Repetitive Peak Forward Surge Current (Per Diode)

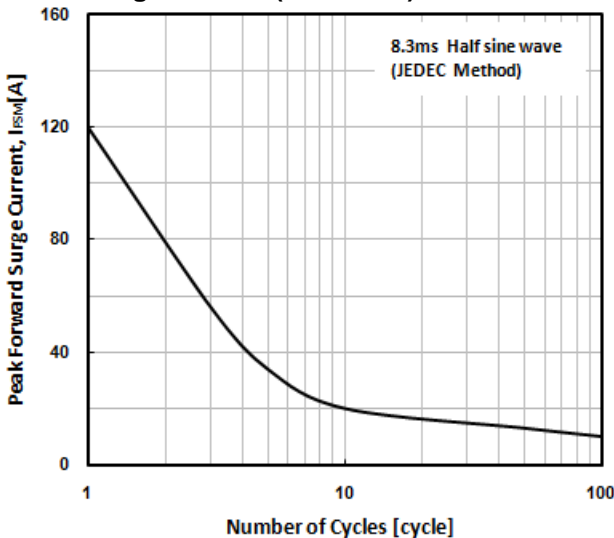
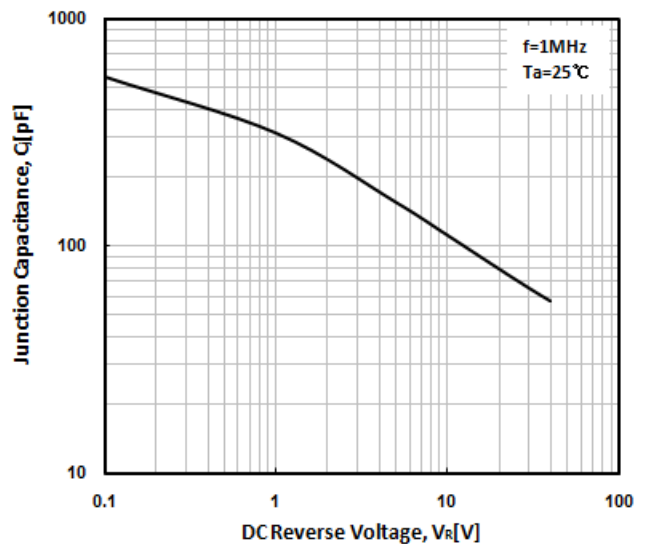
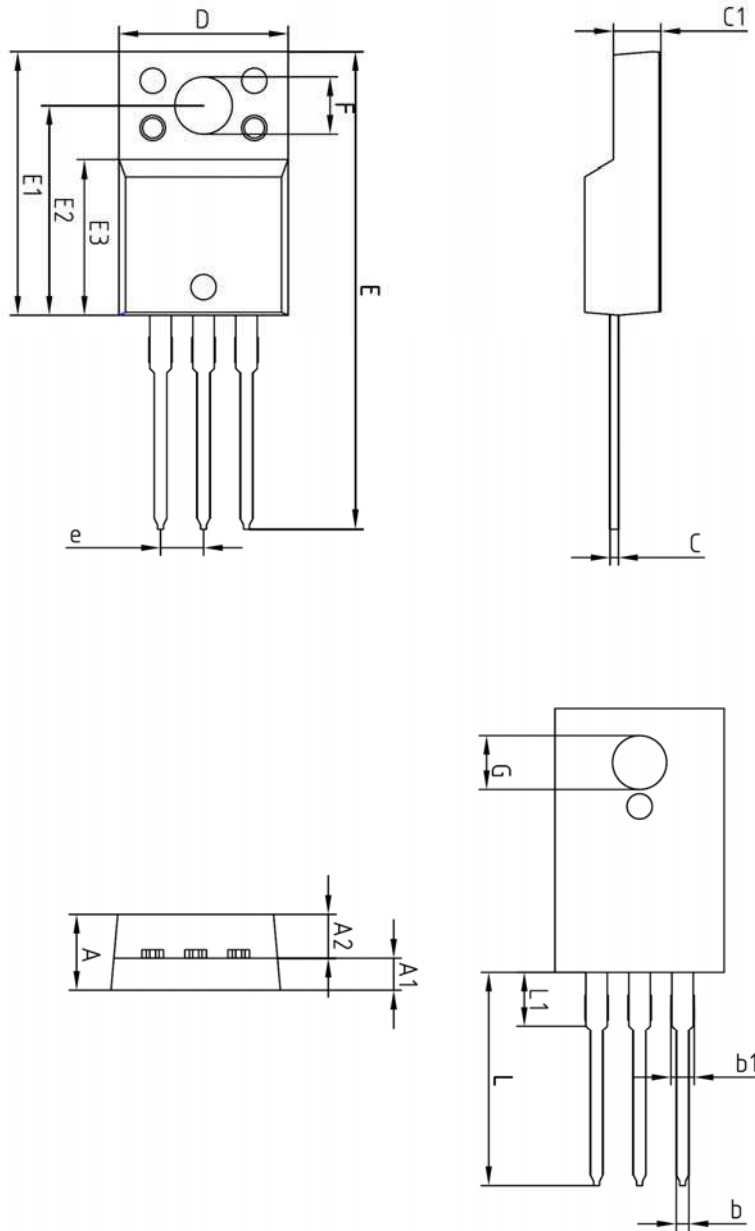

Fig. 6) Typical Junction Capacitance (Per Diode)



Package Outline Dimension



SYMBOL	MILLIMETERS			NOTE
	MINIMUM	NOMINAL	MAXIMUM	
A	-	-	4.60	
A1	2.45	2.50	2.55	
A2	1.95	2.00	2.05	
b	0.65	0.75	0.85	
b1	1.07	1.27	1.47	
C	0.40	0.50	0.60	
C1	2.70	2.80	2.90	
D	9.90	10.00	10.10	
E	28.00	-	28.60	
E1	15.50	15.60	15.70	
E2	12.30	12.40	12.50	
E3	9.15	9.20	9.25	
F	3.30	3.40	3.50	
G	3.10	3.20	3.30	
e	2.54 BSC			
L	12.40	-	13.00	
L1	3.46 BSC			

The AUK Corp. products are intended for the use as components in general electronic equipment (Office and communication equipment, measuring equipment, home appliance, etc.).

Please make sure that you consult with us before you use these AUK Corp. products in equipments which require high quality and / or reliability, and in equipments which could have major impact to the welfare of human life(atomic energy control, airplane, spaceship, transportation, combustion control, all types of safety device, etc.). AUK Corp. cannot accept liability to any damage which may occur in case these AUK Corp. products were used in the mentioned equipments without prior consultation with AUK Corp..

Specifications mentioned in this publication are subject to change without notice.