

Descriptions

- General purpose application
- Switching application

Features

- Low Leakage current
- Low collector saturation voltage enabling low voltage operation
- Complementary pair with SBT2907

PIN Connection

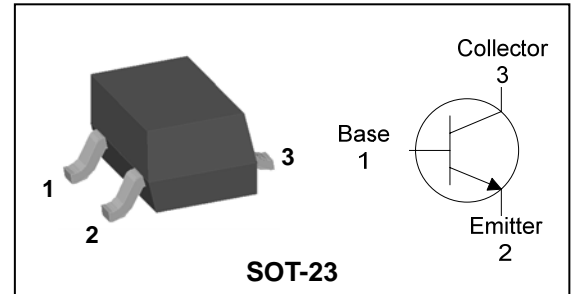

Ordering Information

Type NO.	Marking	Package Code
SBT2222	1B □ ① ②	SOT-23

① Device Code ② Year&Week Code

Absolute maximum ratings

T_a=25°C

Characteristic	Symbol	Ratings	Unit
Collector-Base voltage	V _{CB0}	60	V
Collector-Emitter voltage	V _{CEO}	30	V
Emitter-base voltage	V _{EBO}	5	V
Collector current	I _C	600	mA
Collector dissipation	P _C *	350	mW
Junction temperature	T _j	150	°C
Storage temperature range	T _{stg}	-55~150	°C

* : Package mounted on 99.5% alumina 10×8×0.6mm

Electrical Characteristics

T_a=25°C

Characteristic	Symbol	Test Condition	Min.	Typ.	Max.	Unit
Collector-Base breakdown voltage	BV _{CB0}	I _C =10μA, I _E =0	60	-	-	V
Collector-Emitter breakdown voltage	BV _{CEO}	I _C =1mA, I _B =0	30	-	-	V
Emitter-Base breakdown voltage	BV _{EBO}	I _E =10μA, I _C =0	5	-	-	V
Collector cut-off current	I _{CB0}	V _{CB} =60V, I _E =0	-	-	20	nA
DC current gain	h _{FE}	V _{CE} =10V, I _C =10mA	100	-	-	-
Collector-Emitter saturation voltage	V _{CE(sat)}	I _C =150mA, I _B =15mA	-	-	0.4	V
Transition frequency	f _T	V _{CE} =20V, I _C =20mA, f=100MHz	250	-	-	MHz
Collector output capacitance	C _{ob}	V _{CB} =10V, I _E =0, f=1MHz	-	-	8	pF
Delay time	t _d	V _{CC} =30V _{dc} , V _{BE(off)} =0.5V _{dc} , I _C =150mA _{dc} , I _{B1} =15mA _{dc}	-	-	10	ns
Rise time	t _r		-	-	25	ns
Storage time	t _s	V _{CC} =30V _{dc} , I _C =150mA _{dc} , I _{B1} =I _{B2} =15mA _{dc}	-	-	225	ns
Fall Time	t _f		-	-	60	ns

Electrical Characteristic Curves

Fig. 1 P_C - T_a

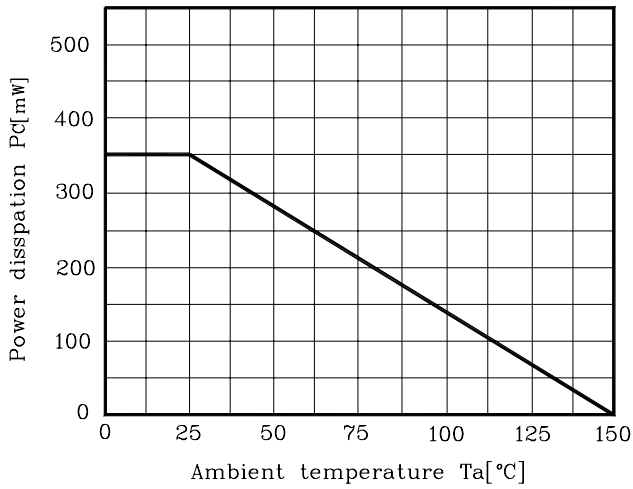

Fig. 2 h_{FE} - I_C

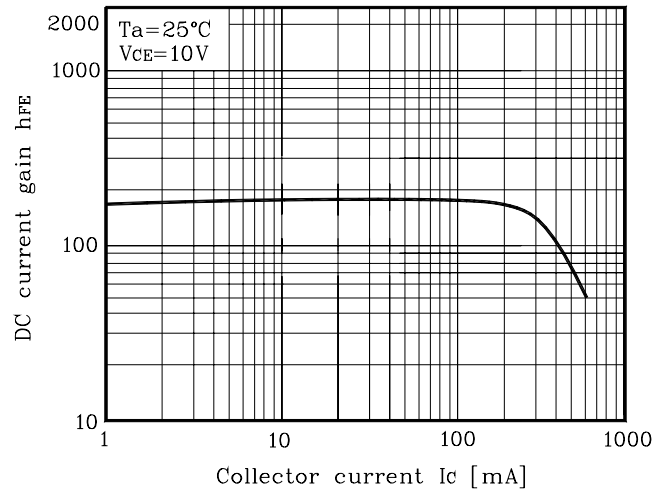

Fig. 3 $V_{CE(sat)}$ - I_C

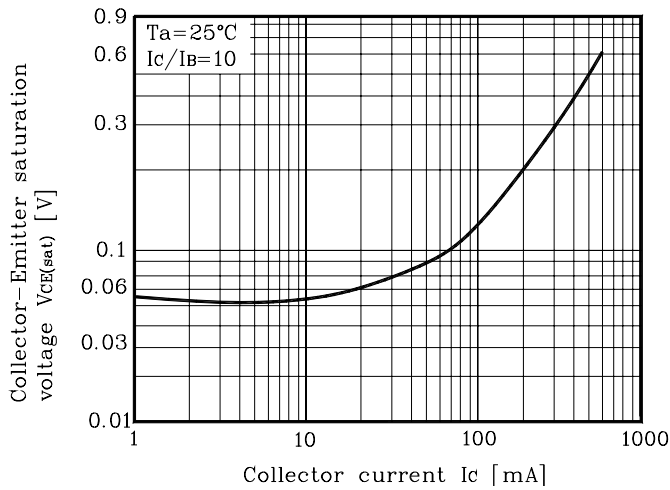
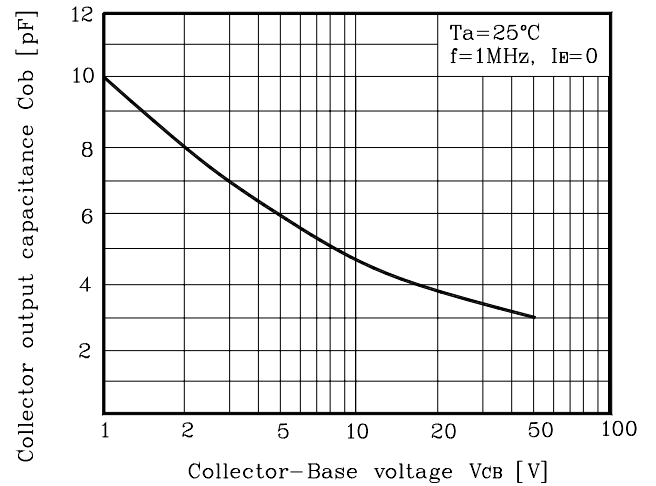
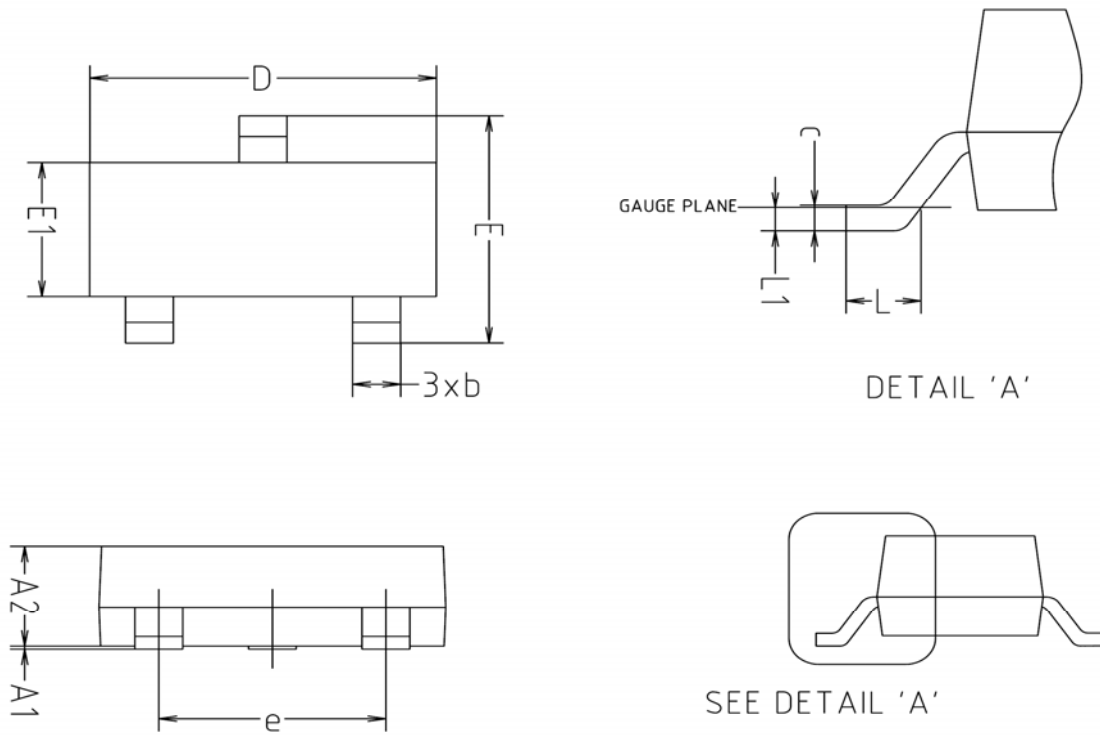

Fig. 4 C_{ob} - V_{CB}



Outline Dimension



SYMBOL	MILLIMETERS			NOTE
	MINIMUM	NOMINAL	MAXIMUM	
A1	0.00	-	0.10	
A2	0.82	-	1.02	
b	0.39	0.42	0.45	
c	0.09	0.12	0.15	
D	2.80	2.90	3.00	
E	2.20	2.40	2.60	
E1	1.20	1.30	1.40	
e	1.90BSC			
L	0.20	-	-	
L1	0.12BSC			

※Recommend PCB solder land [Unit: mm]

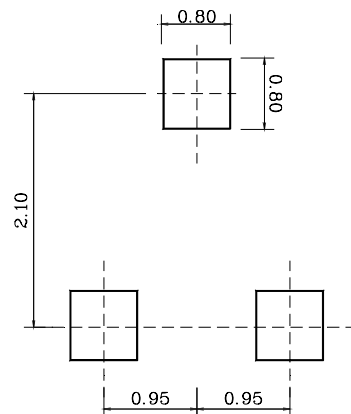

The AUK Corp. products are intended for the use as components in general electronic equipment (Office and communication equipment, measuring equipment, home appliance, etc.).

Please make sure that you consult with us before you use these AUK Corp. products in equipments which require high quality and / or reliability, and in equipments which could have major impact to the welfare of human life(atomic energy control, airplane, spaceship, transportation, combustion control, all types of safety device, etc.). AUK Corp. cannot accept liability to any damage which may occur in case these AUK Corp. products were used in the mentioned equipments without prior consultation with AUK Corp..

Specifications mentioned in this publication are subject to change without notice.