

1. Material Substrate GaAlAs (N Type) Removed
Epitaxial Layer GaAlAs (P/N Type)

2. Electrode N(Cathode) Side Gold Alloy
P(Anode) Side Gold Alloy

3. Electro-Optical Characteristics

Parameter	Symbol	Min	Typ	Max	Unit	Condition
Forward Voltage	$V_{F(1)}$		1.1		V	IF=10uA
	$V_{F(2)}$		1.6	1.9	V	IF=50mA
Reverse Voltage	V_R	5			V	IR=10uA
Power	P_O	12	17		mW	IF=50mA
Wavelength	λ_P		850		nm	IF=50mA
	$\Delta\lambda$		45		nm	IF=50mA
Rise Time	T_r		25		ns	
Fall Time	T_f		13		ns	

※ Note : Power is measured by Sorter E/T system with bare chip.

4. Mechanical Data

- (a) Emission Area ----- 10.0mil x 10.0mil
- (b) Bottom Area ----- 11.0mil x 11.0mil
- (c) Bonding Pad ----- 110um
- (d) Chip Thickness ----- 7mil
- (e) Junction Height ----- 5.7mil

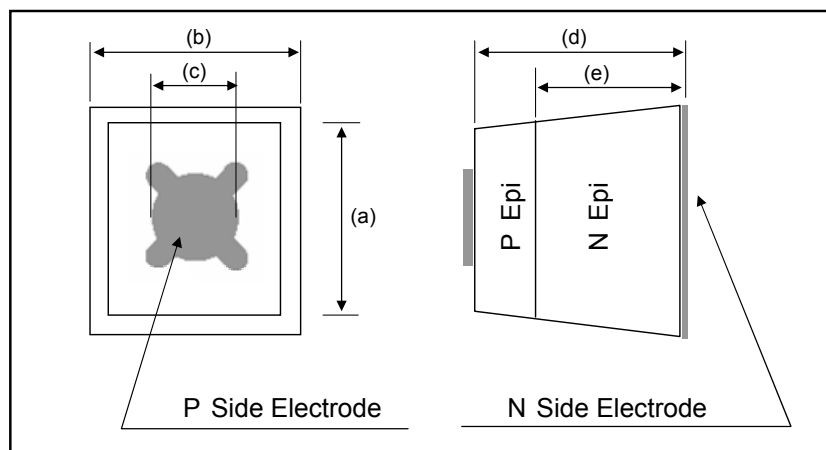

AUK Corp.

Eoyang factory, 513-5 Eoyang-dong, Iksan, 570-210, Korea

Tel. +82 63 839 1111 Fax. +82 63 835 8259

www.auk.co.kr

