

Photo Interrupter

KPI511

Description

The KPI511 is a high performance transmissive type photo interrupter, combines high-output GaAs IRED with high sensitive phototransistor.

Features

- PWB direct mount type.
- Widely applicable.
- 5.0mm gap.
- RoHS compliant.



Applications

- Cameras.
- Copiers.
- Printers.
- Ticket vending machines.

Absolute Maximum Ratings (T_a=25°C, Unless otherwise specified)

Characteristic		Symbol	Ratings	Unit
Input	Power Dissipation	P _D	75	mW
	Forward Current	I _F	40	mA
	Reverse Voltage	V _R	2	V
	Peak Forward Current ^{*1}	I _{FP}	1	A
Output	Power Dissipation	P _D	50	mW
	Collector Current	I _C	20	mA
	Collector-Emitter Voltage	V _{CEO}	30	V
	Emitter-Collector Voltage	V _{ECO}	5	V
Operating Temperature ^{*2}		T _{opr}	0 ~ +65	°C
Storage Temperature ^{*2}		T _{stg}	-40 ~ +70	°C
Soldering Temperature ^{*3}		T _{sol}	260	°C

*1 : Pulse width (tw) ≤ 100μs, Period (T) = 10msec.

*2 : No icebond or dew.

*3 : The soldering should be 1mm away from bottom of the case t=within 5sec

The contents of this data sheet are subject to change without advance notice for the purpose of improvement.
When using this product, would you please refer to the latest specifications.

Electrical Characteristics (T_a=25°C)

Characteristic		Symbol	Test Condition	Min.	Typ.	Max.	Unit
Input	Forward Voltage	V _F	I _F =20mA	1.0	1.2	1.7	V
	Peak Wavelength	λ _p	I _F =20mA	-	940	-	nm
	Reverse Current	I _R	V _R =3V	-	-	10	uA
Output	Dark Current	I _{CEO}	V _{CE} =10V, E=0lux	-	1	100	nA
	Peak Wavelength	λ _p	-	-	880	-	nm
Transfer Characteristics	Collector Current	I _C	V _{CE} =5.0V, I _F =20mA (Non shading)	0.2	-	-	mA
	Leakage current	I _{CEOD}	I _F =10mA, V _{CE} =5V Shading	-	0.5	10	uA
	C-E Saturation Voltage	V _{CE(sat)}	I _C =0.4mA, I _F =20mA	-	-	0.4	V
Response Time	Turn On Time ^{*4}	T _{on}	V _{CC} =5.0V, I _C =0.1mA RL=1KΩ	-	15	-	usec
	Turn Off Time ^{*4}	T _{off}		-	15	-	usec

*4 : Adjust amplitude and offset of square wave so that V_{out} transitions from 10% to 90% of V_{out} range of the The Device Under Test(DUT)

- Circuit for Measuring Response Time

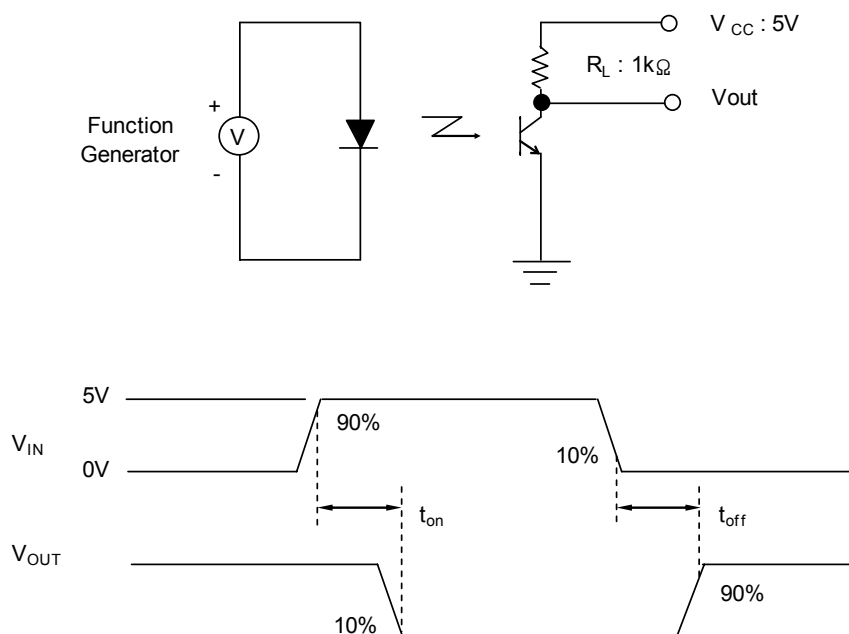

The contents of this data sheet are subject to change without advance notice for the purpose of improvement. When using this product, would you please refer to the latest specifications.

Electrical and optical characteristic curves

Collector power dissipation Vs. Ambient temperature

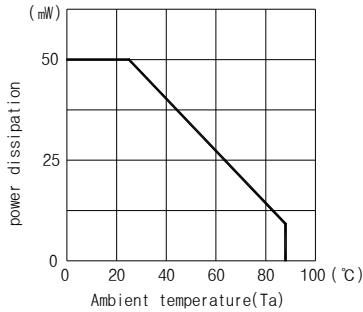

Forward current Vs. Forward voltage

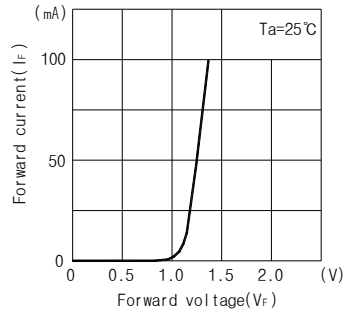

Collector Current Vs. Forward Current

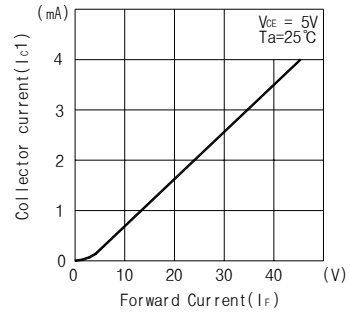

Collector Current Vs. Collector-Emitter Voltage

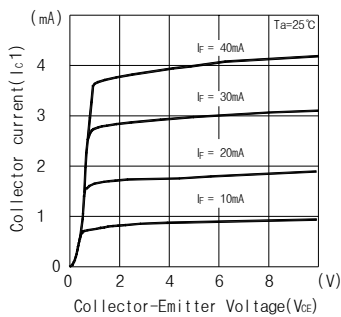

Relative Collector Current Vs. Ambient temperature

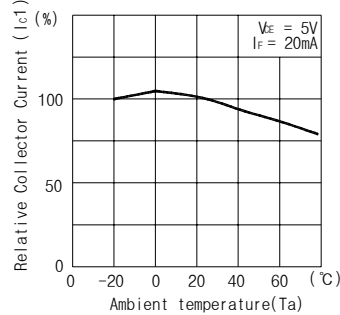

Collector Current Vs. Ambient temperature

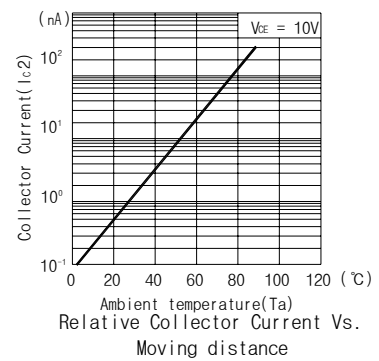

Switching time Vs. Load resistance

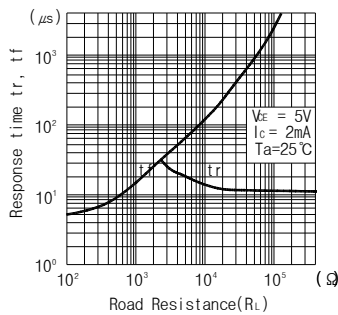

Relative Collector Current Vs. Moving distance

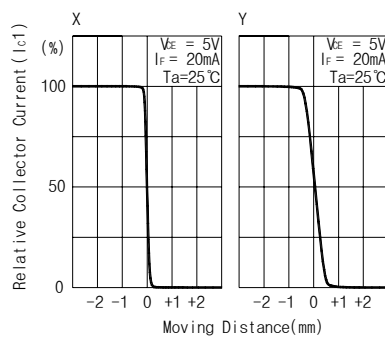

Switching time measurement circuit

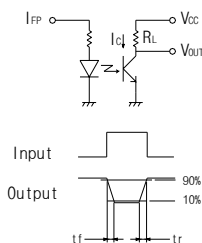

Method of measuring position detection characteristic

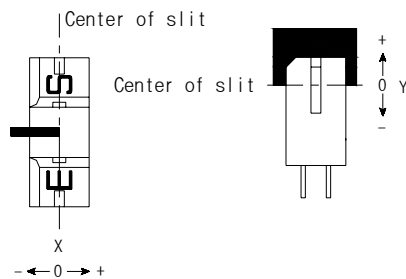

The contents of this data sheet are subject to change without advance notice for the purpose of improvement. When using this product, would you please refer to the latest specifications.

