

## Description

- Medium power amplifier

## Features

- Large collector current :  $I_C = 500\text{mA}$
- Low collector saturation voltage enabling low-voltage operation
- Complementary pair with 2SA1979U

## PIN Connection

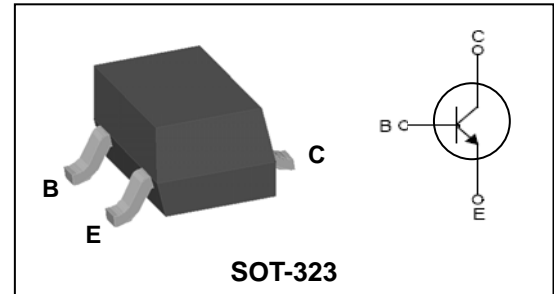

## Ordering Information

Type NO.	Marking	Package Code
2SC5342U	B□	SOT-323

□ :  $h_{FE}$  rank

## Absolute maximum ratings

( $T_a = 25^\circ\text{C}$ )

Characteristic	Symbol	Ratings	Unit
Collector-Base voltage	$V_{CB0}$	40	V
Collector-Emitter voltage	$V_{CEO}$	32	V
Emitter-Base voltage	$V_{EBO}$	5	V
Collector current	$I_C$	500	mA
Collector dissipation	$P_C$	200	mW
Junction temperature	$T_j$	150	$^\circ\text{C}$
Storage temperature	$T_{stg}$	-55 ~ 150	$^\circ\text{C}$

## Electrical Characteristics

( $T_a = 25^\circ\text{C}$ )

Characteristic	Symbol	Test Condition	Min.	Typ.	Max.	Unit
Collector-Base breakdown voltage	$BV_{CB0}$	$I_C = 100\mu\text{A}$ , $I_E = 0$	40	-	-	V
Collector-Emitter breakdown voltage	$BV_{CEO}$	$I_C = 1\text{mA}$ , $I_B = 0$	32	-	-	V
Emitter-Base breakdown voltage	$BV_{EBO}$	$I_E = 10\mu\text{A}$ , $I_C = 0$	5	-	-	V
Collector cut-off current	$I_{CB0}$	$V_{CB} = 40\text{V}$ , $I_E = 0$	-	-	0.1	$\mu\text{A}$
Emitter cut-off current	$I_{EBO}$	$V_{EB} = 5\text{V}$ , $I_C = 0$	-	-	0.1	$\mu\text{A}$
DC current gain	$h_{FE}^*$	$V_{CE} = 1\text{V}$ , $I_C = 100\text{mA}$	70	-	240	-
Collector-Emitter saturation voltage	$V_{CE(sat)}$	$I_C = 100\text{mA}$ , $I_B = 10\text{mA}$	-	-	0.25	V
Transition frequency	$f_T$	$V_{CE} = 6\text{V}$ , $I_C = 20\text{mA}$	-	300	-	MHz
Collector output capacitance	$C_{ob}$	$V_{CB} = 6\text{V}$ , $I_E = 0$ , $f = 1\text{MHz}$	-	7.0	-	pF

\* :  $h_{FE}$  Rank / O : 70~140, Y : 120~240

Electrical Characteristic Curves

Fig. 1  $P_c - T_a$

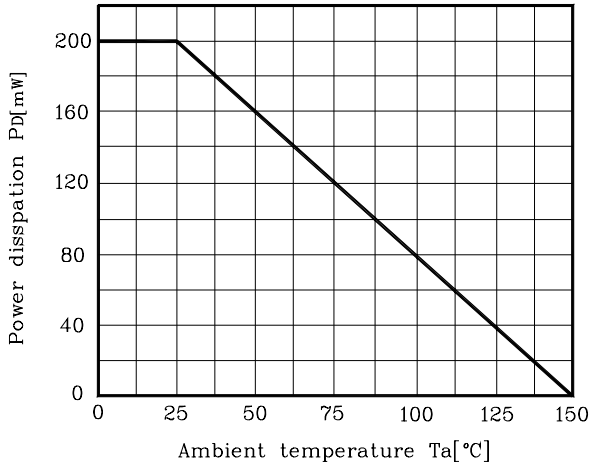

Fig. 2  $I_c - V_{BE}$

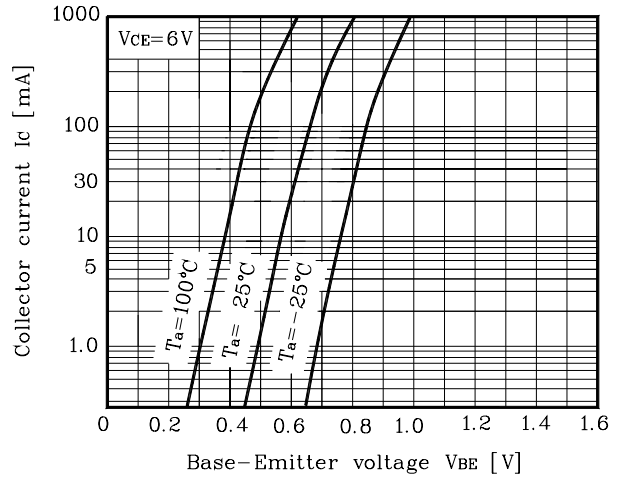

Fig. 3  $I_c - V_{CE}$

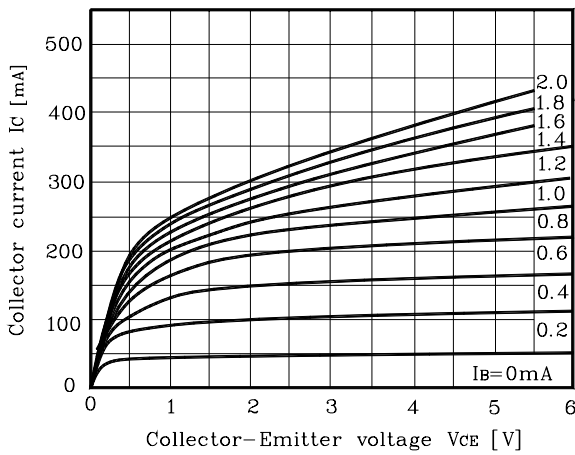

Fig. 4  $V_{CE(SAT)} - I_c$

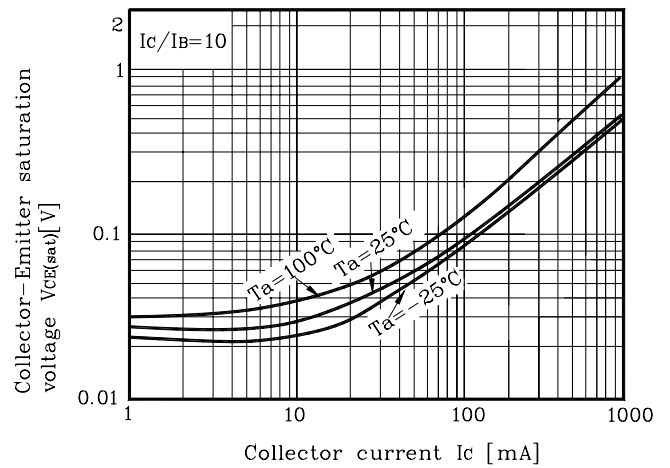
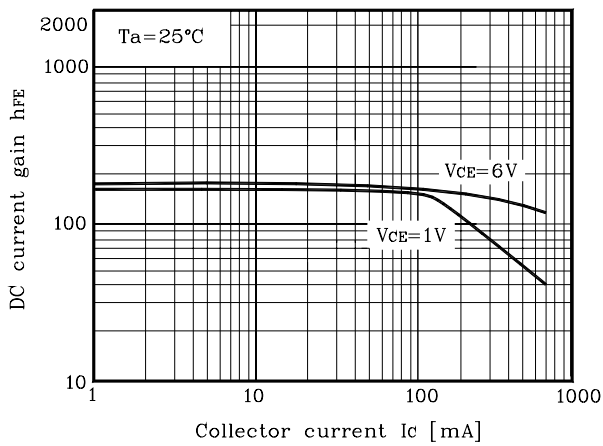
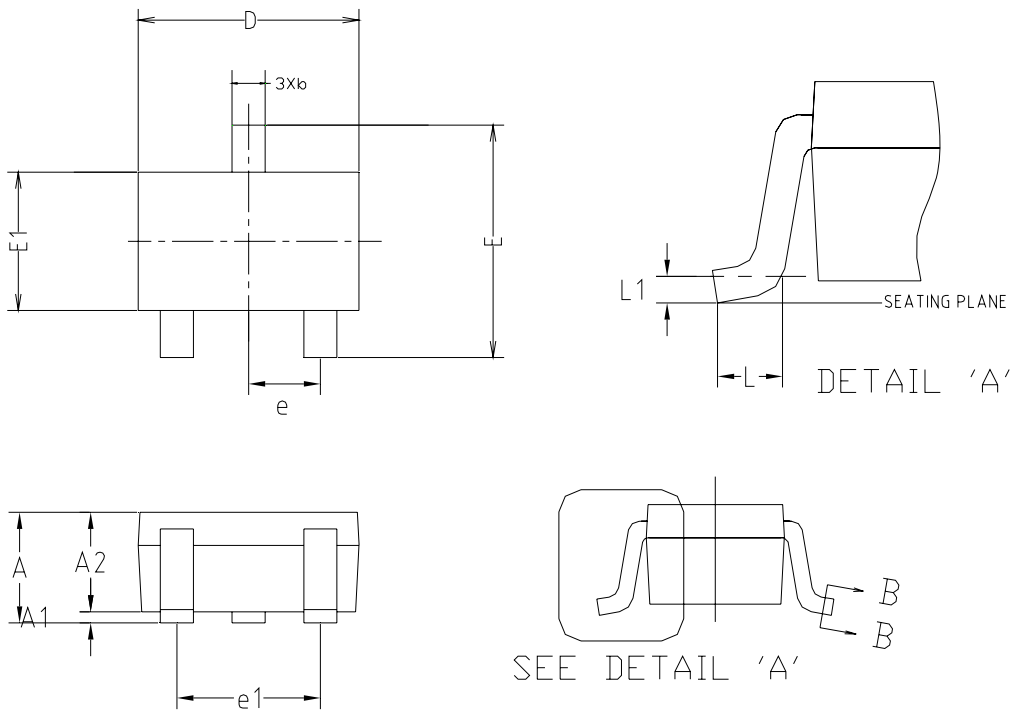

Fig. 5  $h_{FE} - I_c$



Outline Dimension



SYMBOL	MILLIMETERS			NOTE
	MINIMUM	NOMINAL	MAXIMUM	
A	0.90	-	1.25	
A1	0.00	-	0.10	
A2	0.85	0.90	0.95	
D	1.90	2.00	2.10	
E	1.95	2.10	2.25	
E1	1.15	1.25	1.35	
e	0.65BSC			
e1	1.20	-	1.40	
L	0.10	-	-	
L1	0.12BSC			

※Recommend PCB solder land [Unit: mm]

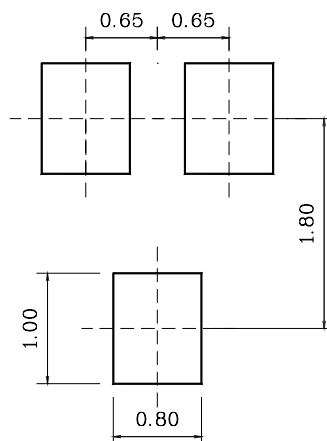

**The AUK Corp. products are intended for the use as components in general electronic equipment (Office and communication equipment, measuring equipment, home appliance, etc.).**

**Please make sure that you consult with us before you use these AUK Corp. products in equipments which require high quality and / or reliability, and in equipments which could have major impact to the welfare of human life(atomic energy control, airplane, spaceship, transportation, combustion control, all types of safety device, etc.). AUK Corp. cannot accept liability to any damage which may occur in case these AUK Corp. products were used in the mentioned equipments without prior consultation with AUK Corp..**

**Specifications mentioned in this publication are subject to change without notice.**