

Description

- General small signal amplifier

Features

- Low collector saturation voltage : $V_{CE(sat)} = -0.3V(\text{Max.})$
- Low output capacitance : $C_{ob} = 4pF(\text{Typ.})$
- Complementary pair with 2SC5343E

PIN Connection

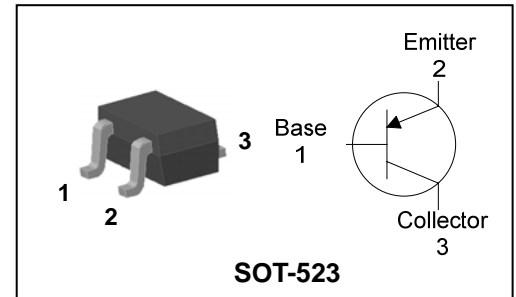

Ordering Information

Type NO.	Marking	Package Code
2SA1980E	A ① ② ③	SOT-523

① Device Code ② hFE Rank ③ Year&Week Code

Absolute maximum ratings

($T_a = 25^\circ\text{C}$)

Characteristic	Symbol	Ratings	Unit
Collector-Base voltage	V_{CBO}	-50	V
Collector-Emitter voltage	V_{CEO}	-50	V
Emitter-Base voltage	V_{EBO}	-5	V
Collector current	I_C	-150	mA
Collector dissipation	P_C	150	mW
Junction temperature	T_j	150	$^\circ\text{C}$
Storage temperature	T_{stg}	-55~150	$^\circ\text{C}$

Electrical Characteristics

($T_a = 25^\circ\text{C}$)

Characteristic	Symbol	Test Condition	Min.	Typ.	Max.	Unit
Collector-Base breakdown voltage	BV_{CBO}	$I_C = -100\mu\text{A}, I_E = 0$	-50	-	-	V
Collector-Emitter breakdown voltage	BV_{CEO}	$I_C = -1\text{mA}, I_B = 0$	-50	-	-	V
Emitter-Base breakdown voltage	BV_{EBO}	$I_E = -10\mu\text{A}, I_C = 0$	-5	-	-	V
Collector cut-off current	I_{CBO}	$V_{CB} = -50\text{V}, I_E = 0$	-	-	-0.1	μA
Emitter cut-off current	I_{EBO}	$V_{EB} = -5\text{V}, I_C = 0$	-	-	-0.1	μA
DC current gain	h_{FE}^*	$V_{CE} = -6\text{V}, I_C = -2\text{mA}$	70	-	700	-
Collector-Emitter saturation voltage	$V_{CE(sat)}$	$I_C = -100\text{mA}, I_B = -10\text{mA}$	-	-	-0.3	V
Transition frequency	f_T	$V_{CE} = -10\text{V}, I_C = -1\text{mA}$	80	-	-	MHz
Collector output capacitance	C_{ob}	$V_{CB} = -10\text{V}, I_E = 0, f = 1\text{MHz}$	-	4	7	pF
Noise figure	NF	$V_{CE} = -6\text{V}, I_C = -0.1\text{mA}$ $f = 1\text{KHz}, R_g = 10\text{K}\Omega$	-	-	10	dB

*: h_{FE} rank / O : 70~140, Y : 120~240, G : 200~400, L : 300~700

Electrical Characteristic Curves

Fig. 1 P_C - T_a

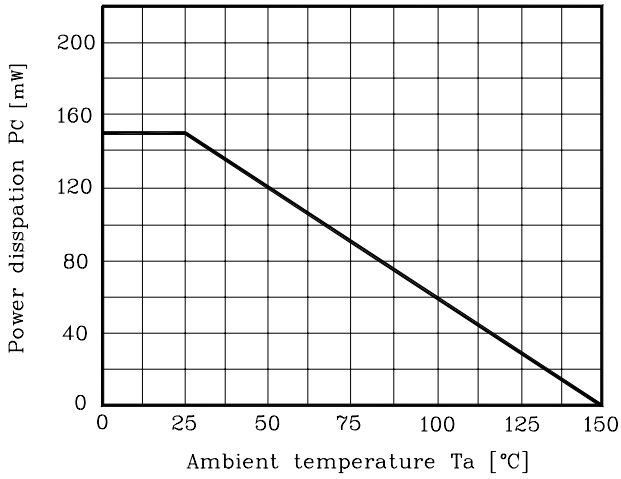

Fig. 2 I_C - V_{BE}

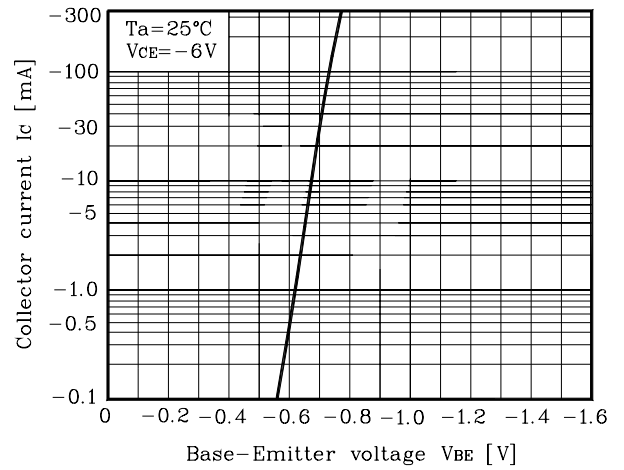

Fig. 3 I_C - V_{CE}

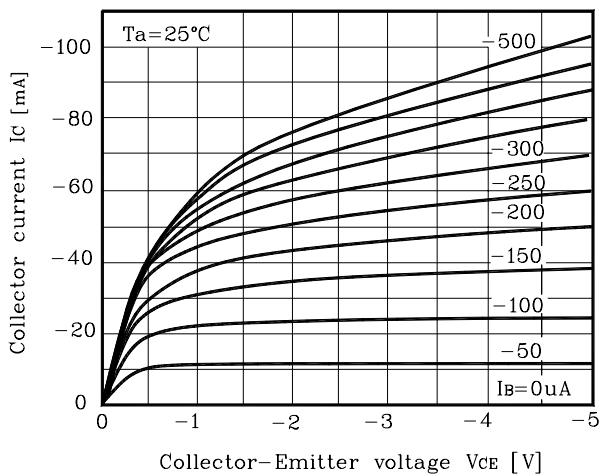

Fig. 4 h_{FE} - I_C

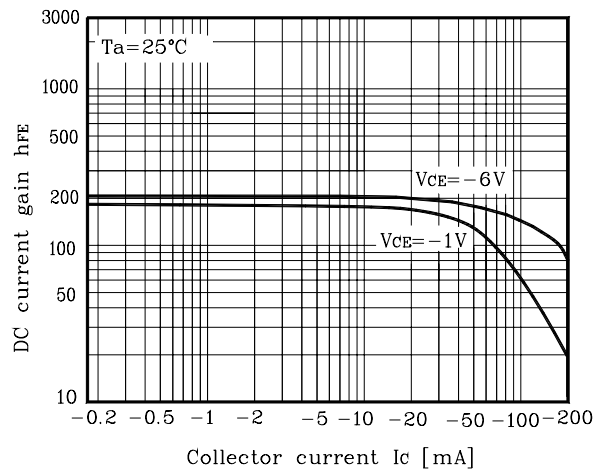
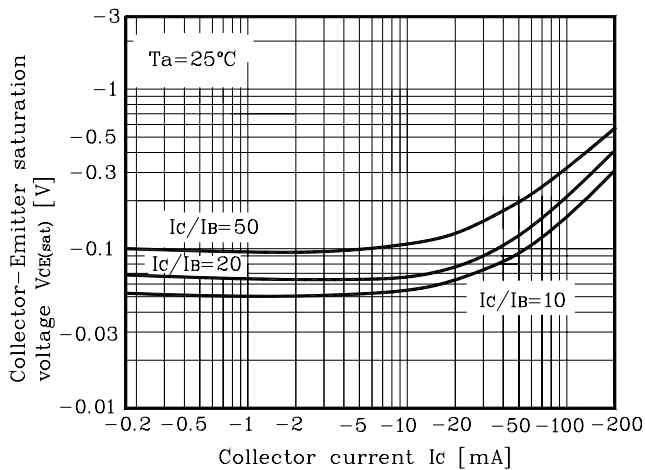
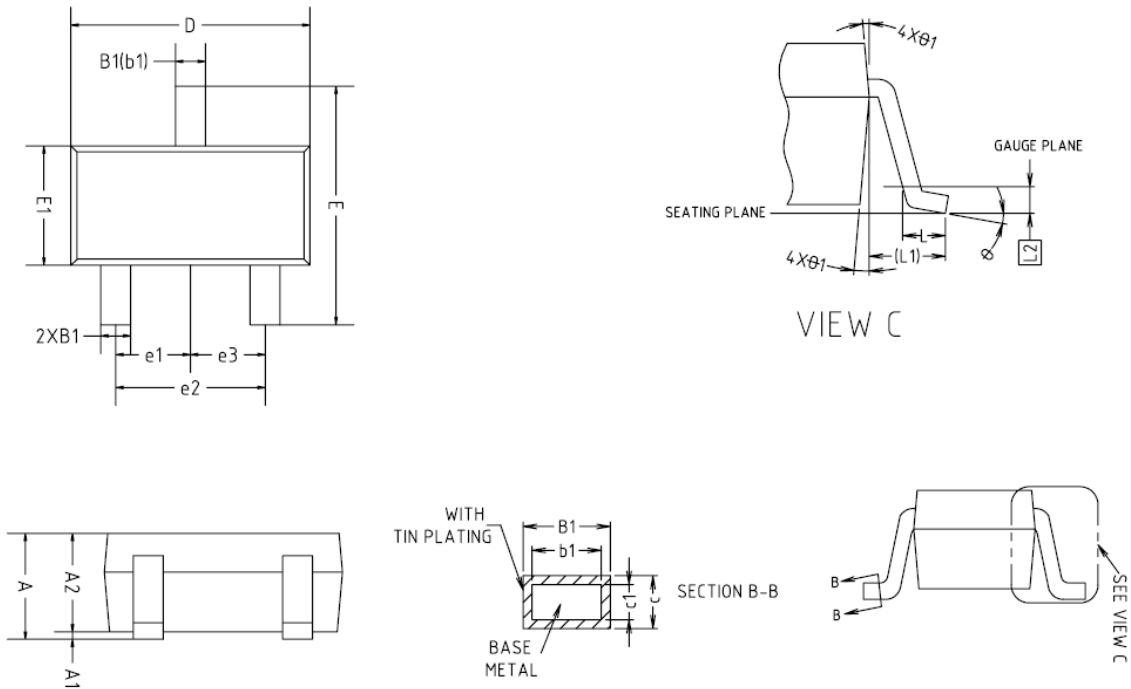

Fig. 5 $V_{CE(sat)}$ - I_C



Outline Dimension



SYMBOL	MILLIMETERS			NOTE
	MINIMUM	NOMINAL	MAXIMUM	
A	—	—	0.80	
A1	0.00	—	0.10	
A2	0.65	0.70	0.75	
B1	0.19	—	0.24	
b1	0.17	—	0.21	
c	0.13	—	0.15	
c1	0.10	—	0.12	
D	1.48	1.58	1.68	
E	1.50	1.60	1.70	
E1	0.66	0.76	0.86	
e1	0.50 BSC			
e2	1.00 BSC			
e3	0.50 BSC			
L	0.15	0.205	0.30	
L1	0.40 REF			
L2	0.15 BSC			
φ	0°	—	8°	
θ1	4°	—	10°	

※Recommend PCB solder land [Unit: mm]

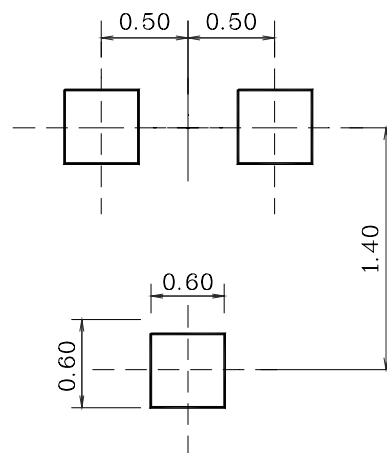

The AUK Corp. products are intended for the use as components in general electronic equipment (Office and communication equipment, measuring equipment, home appliance, etc.).

Please make sure that you consult with us before you use these AUK Corp. products in equipments which require high quality and / or reliability, and in equipments which could have major impact to the welfare of human life(atomic energy control, airplane, spaceship, transportation, combustion control, all types of safety device, etc.). AUK Corp. cannot accept liability to any damage which may occur in case these AUK Corp. products were used in the mentioned equipments without prior consultation with AUK Corp..

Specifications mentioned in this publication are subject to change without notice.