

FEATURES

- -33 dB Dynamic EVM @ P_{OUT} = +19 dBm with IEEE 802.11a 64 QAM OFDM at 54 Mbps
- 220 mA Supply Current @ +19 dBm with IEEE 802.11a 64 QAM OFDM at 54 Mbps
- 29 dB of Linear Power Gain
- 3.3 V Supply Voltage
- Integrated Power Detector with 20 dB Dynamic Range
- 50 Ω -Internally Matched RF Ports
- Leadfree and RoHS Compliant
- 3 x 3 x 0.55 mm Leadless Package

APPLICATIONS

- 802.11a/n WLAN, WHDI

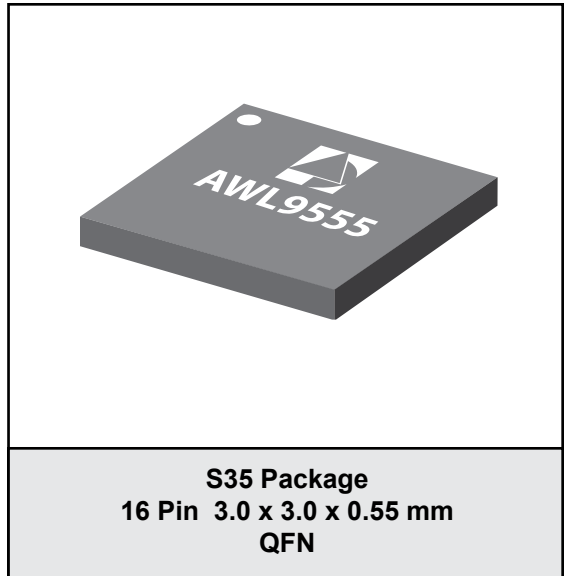

PRODUCT DESCRIPTION

The ANADIGICS AWL9555 high performance InGaP HBT Power Amplifier is designed for transmit applications in the 4.90 to 5.85 GHz Band. The module is internally matched to 50 ohms on input and output ports requiring no external RF matching components. The low profile 3.0 x 3.0 x 0.55 mm package minimizes PCB area making it ideal for MIMO applications. The PA provides industry leading linearity across the full frequency band under 802.11a/n modulation standards.

The power detector is temperature compensated on chip enabling a single ended output voltage with excellent accuracy over a wide range of operating temperatures. The PA is biased with a single 3.3V supply and consumes ultra low current in the off mode.

The AWL9555 is manufactured using advanced InGaP HBT technology that offers state-of-the-art performance, reliability, temperature stability and ruggedness.

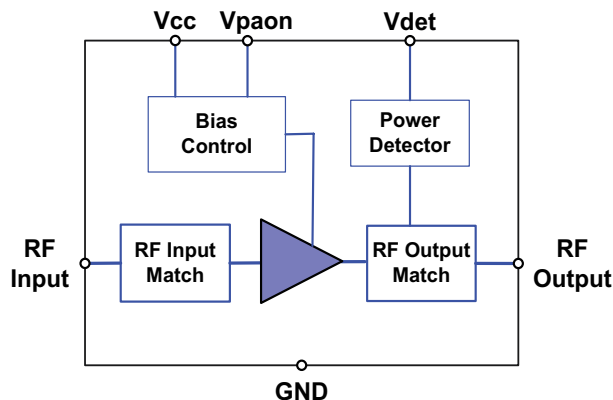

Figure 1: Block Diagram

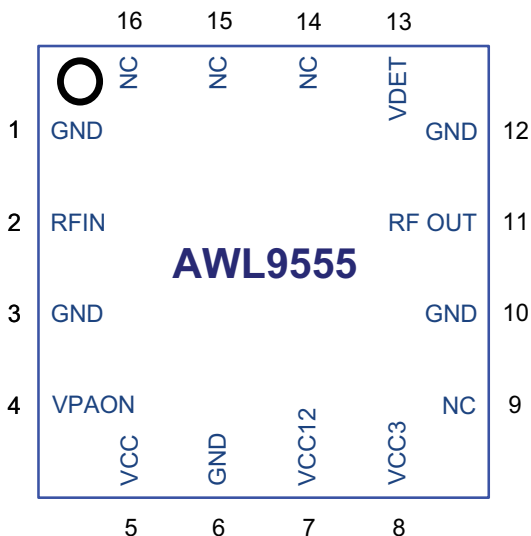

Figure 2: Pinout Diagram (Top View)

Table 1: Pin Description

PIN	NAME	DESCRIPTION	PIN	NAME	DESCRIPTION
1	GND	Ground	9	N/C	No Connection
2	RFIN	RF Input Port	10	GND	Ground
3	GND	Ground	11	RFOUT	RF Output Port
4	VPAON	PA Enable. On/Off control for the power amplifier.	12	GND	Ground
5	VCC	Bias Circuit Supply	13	VDET	Power Detector Output Voltage
6	GND	Ground	14	N/C	No Connection
7	VCC12	PA Collector Supply, Stages 1 & 2	15	N/C	No Connection
8	VCC3	PA Collector Supply, Stage 3	16	N/C	No Connection

ELECTRICAL CHARACTERISTICS

Table 2: Absolute Minimum and Maximum Ratings

PARAMETER	MIN	MAX	UNIT	COMMENTS
DC Power Supply Voltages (VCC)	-	+6.0	V	No RF signal applied
RF Input Level	-	+5	dBm	Modulated
Operating Ambient Temperature	-40	+85	°C	
Storage Temperature	-55	+150	°C	
Storage Humidity	-	60	%	
Shipping Temperature	-55	+150	°C	
Shipping Humidity	-	60	%	
ESD Tolerance	1000 600 50	- - -	V	Charged Device Model (CDM), all pins Human Body Model (HBM), all pins Machine Model (MM), all pins
MSL Rating	-	MSL-2		
Reflow Temperature	-	260	°C	

Notes:

1. Stresses in excess of the absolute ratings may cause permanent damage. Functional operation is not implied under these conditions. Exposure to absolute ratings for extended periods of time may adversely affect reliability.

Table 3: Operating Ranges

PARAMETER	MIN	TYP	MAX	UNIT	COMMENTS
Operating Frequency Ranges	4900	-	5850	MHz	802.11a/n
DC Power Supply Voltage (V _{CC})	+3.0	+3.3	+3.6	V	With RF applied
Control Pin Voltage (PA _{ON})	+2.7 0	+3.3 0	+V _{CC} +0.4	V	Logic High/On Logic Low/Off
Ambient Temperature	-40	-	+85	°C	

Notes:

The Device may be operated safely over these conditions; however, parametric performance is guaranteed only over the conditions defined in the electrical specifications.

Table 4: Electrical Specifications - 802.11a/n Transmit Path
 (T_c = +25 °C, V_{CC} = +3.3 V, PA_{ON}2 = +3.3 V, V_{TX}2 = +3.3 V, V_{RX}2 = V_{BT}2 = 0 V)
 Static Mode 64 QAM OFDM 54 Mbps

PARAMETER	MIN	TYP	MAX	UNIT	COMMENTS
Power Gain	25 25	32 28	35 32	dB	4900 MHz to 5150 MHz 5150 MHz to 5850 MHz
Gain Flatness	- -	±2.5 ±0.25	- -	dB	Across full band Across any 40 MHz band
Error Vector Magnitude (EVM) ⁽¹⁾	- -	-33 220	- -	dB mA	P _{OUT} = 19 dBm, Dyn Mode, 54 Mbps Avg current during packet
	- 175	-34 200	-30 225	dB mA	P _{OUT} = 18 dBm, Dyn Mode, 54 Mbps Avg current during packet
	- -	-35 175	- -	dB mA	P _{OUT} = 15 dBm, Dyn Mode, 54 Mbps Avg current during packet
	- -	-36 135	- -	dB mA	P _{OUT} = 5 dBm, Dyn Mode, 54 Mbps Avg current during packet
Transmit Mask	Pass	-	-	N/A	OFDM, all rates, P _{OUT} = 19 dBm
PA Noise Figure	-	8	-	dB	
Group Delay	-	1.5	-	nS	
Group Delay Variation	-	0.5	-	nS	For any 20 MHz channel
Input Return Loss	-	9	-	dB	
Output Return Loss	-	11	-	dB	
TX Output Spurious Levels 2 fo 3 fo 4 fo	- - -	-24 -37 -57	- - -	dBm	P _{OUT} = +19 dBm, CW signal
TX Output Spurious Levels Non-Harmonics	-	-60	-	dBm/ MHz	For power levels up to 19 dBm, OFDM @ 54 Mbps
Stability and Load Mismatch Susceptibility	-	-65	-	dBc	Unconditionally stable and no damage, 5:1 VSWR, up to P _{OUT} = 19 dBm, OFDM 54 Mbps
Settling Time	-	0.9	-	uS	Within 0.5 dB of final value
I _{CC} Quiescent Current	90	115	140	mA	
Shutdown Current	-	-	5	μA	PA _{ON} set low

Note:

(1) EVM includes system noise floor of 1% (-40 dB).

Table 5: Power Detector Electrical Specification
 (T_C = +25 °C, V_{CC} = +3.3 V, P_{AON} = +3.3 V)

PARAMETER	MIN	TYP	MAX	UNIT	COMMENTS
Detector Voltage	600	800	950	mV	P _{OUT} = +18 dBm
Total Internal Load Impedance	-	5	-	kΩ	
Dynamic Range	-	20	-	dB	
Resolution	-	50	-	mV/dB	P _{OUT} > +7 dBm
Video Bandwidth	-	10	-	MHz	Adjustable with External RC Load

5 GHz DATA

Figure 3: Tx Path Gain vs. Output Power Across Frequency (Vcc = +3.3V, Temp = +25 °C 802.11a, 54 Mbps OFDM)

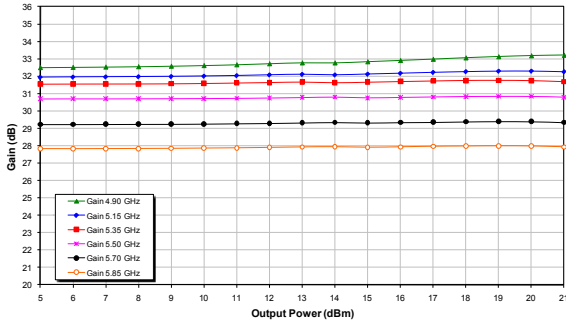

Figure 4: Tx Path Gain vs. Output Power Across Voltage (Freq = 5.5 GHz, Temp = +25 °C 802.11a, 54 Mbps OFDM)

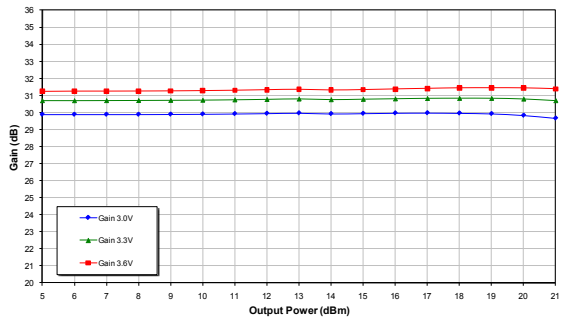

Figure 5: Tx Path Gain vs. Output Power Across Temperature (Freq = 5.5 GHz, Vcc = +3.3 V 802.11a, 54 Mbps OFDM)

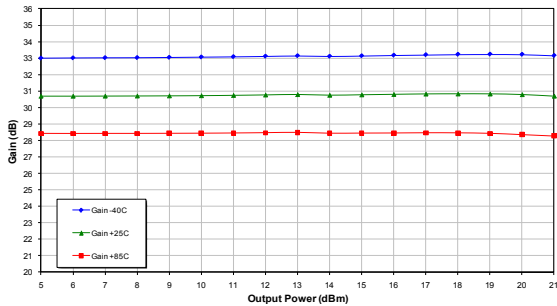

Figure 6: Tx Path Gain vs. Output Power Across Frequency (Vcc = +3.0 V, Temp = +25 °C 802.11a, 54 Mbps OFDM)

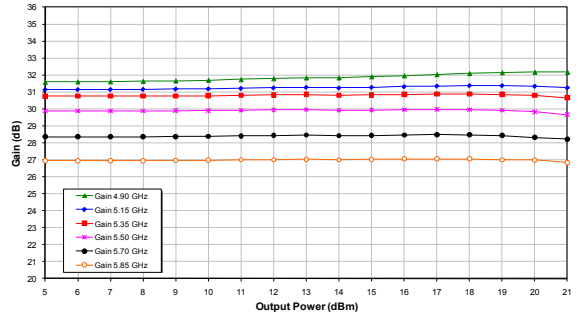

Figure 7: Tx Path Gain vs. Output Power Across Frequency (Vcc = +3.6 V, Temp = +25 °C 802.11a, 54 Mbps OFDM)

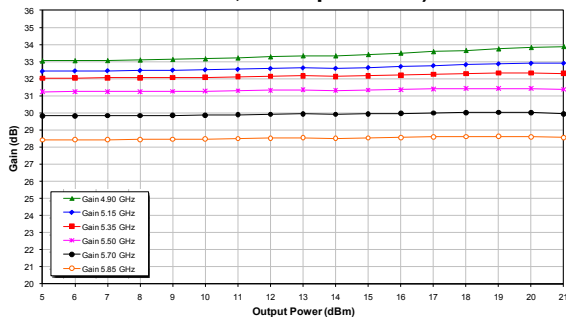

Figure 8: Tx Path Gain vs. Output Power Across Frequency (Vcc = +3.3 V, Temp = -40 °C 802.11a, 54 Mbps OFDM)

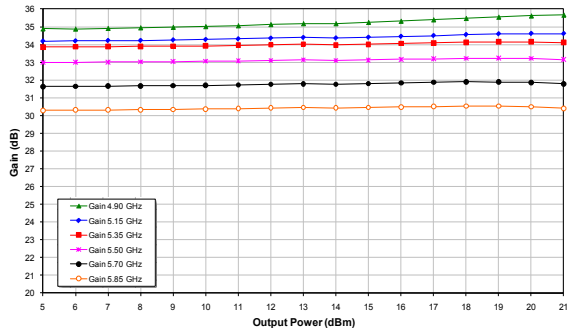

Figure 9: Tx Path Gain vs. Output Power Across Frequency (Vcc = +3.3 V, Temp = +85 °C 802.11a, 54 Mbps OFDM)

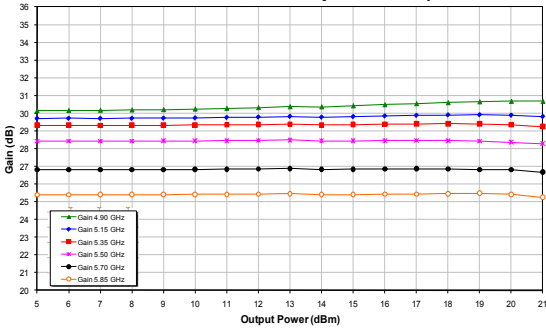

Figure 10: Tx Path Icc vs. Output Power Across Frequency (Vcc = +3.3V, Temp = +25 °C 802.11a, 54 Mbps OFDM)

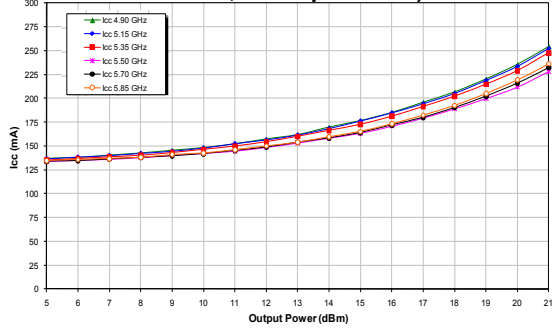

Figure 11: Tx Path Icc vs. Output Power Across Voltage (Freq = 5.5 GHz, Temp = +25 °C 802.11a, 54 Mbps OFDM)

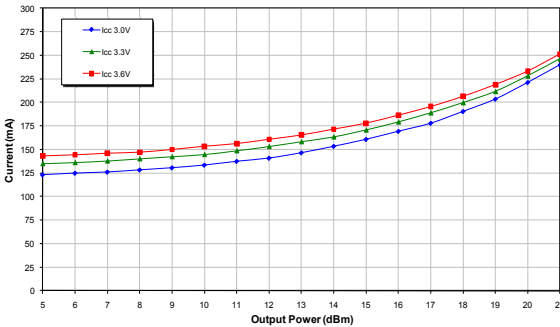

Figure 12: Tx Path Icc vs. Output Power Across Temperature (Freq = 5.5 GHz, Vcc = +3.3 V 802.11a, 54 Mbps OFDM)

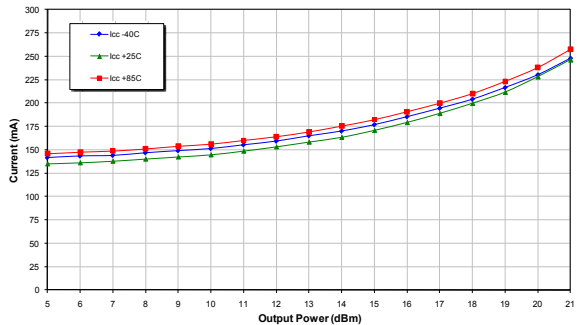

Figure 13: Tx Path Icc vs. Output Power Across Frequency (Vcc = +3.0 V, Temp = +25 °C 802.11a, 54 Mbps OFDM)

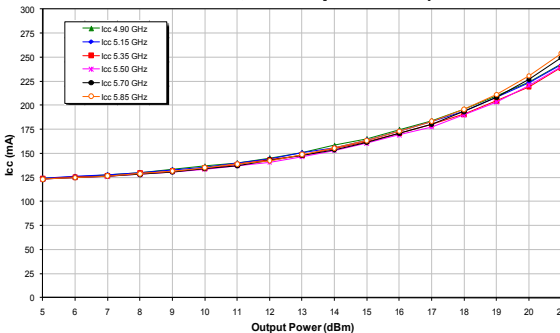

Figure 14: Tx Path Icc vs. Output Power Across Frequency (Vcc = +3.6 V, Temp = +25 °C 802.11a, 54 Mbps OFDM)

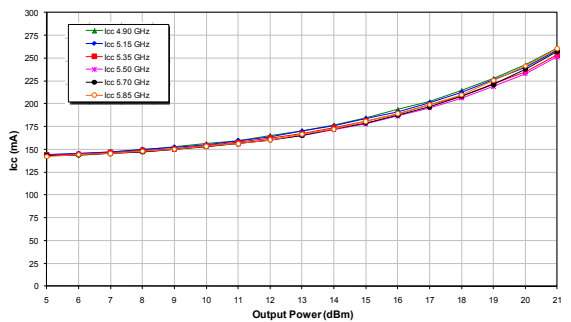

Figure 15: Tx Path Icc vs. Output Power Across Frequency (Vcc = +3.3 V, Temp = -40 °C 802.11a, 54 Mbps OFDM)

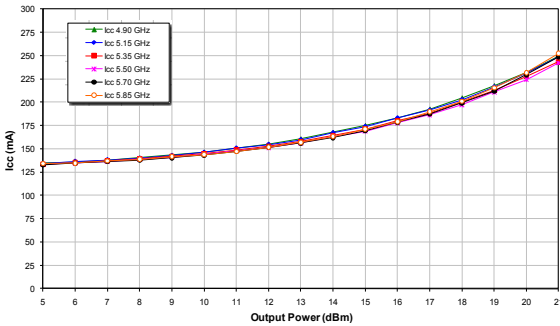

Figure 16: Tx Path Icc vs. Output Power Across Frequency (Vcc = +3.3 V, Temp = +85 °C 802.11a, 54 Mbps OFDM)

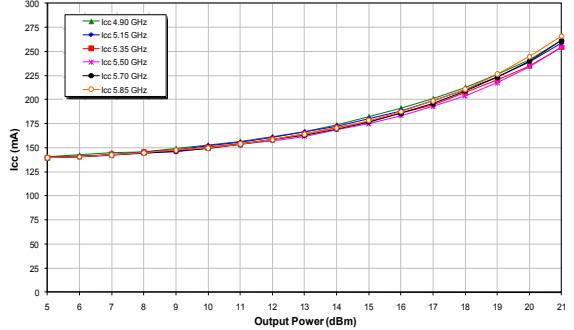

Figure 17: Tx Path Dynamic EVM vs. Output Power Across Frequency (Vcc = +3.3V, Temp = +25 °C, 802.11a, 54 Mbps OFDM)

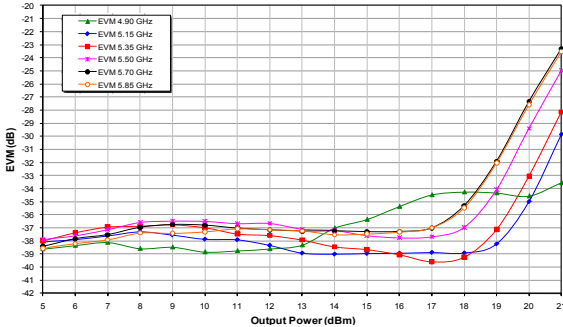

Figure 18: Tx Path Dynamic EVM vs. Output Power Across Voltage (Freq = 5.5 GHz, Temp = +25 °C, 802.11a, 54 Mbps OFDM)

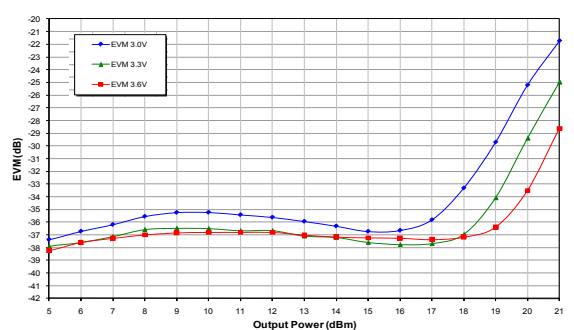

Figure 19: Tx Path Dynamic EVM vs. Output Power Across Temperature (Freq = 5.5 GHz, Vcc = +3.3 V, 802.11a, 54 Mbps OFDM)

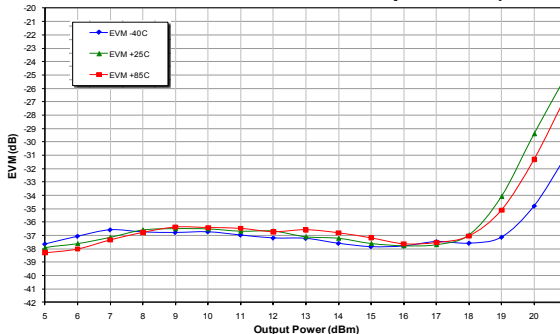

Figure 20: Tx Path Dynamic EVM vs. Output Power Across Frequency (Vcc = +3.0 V, Temp = +25 °C, 802.11a, 54 Mbps OFDM)

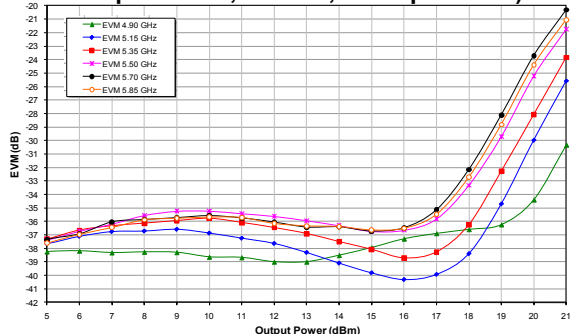

Figure 21: Tx Path Dynamic EVM vs. Output Power Across Frequency (Vcc = +3.6 V, Temp = +25 °C, 802.11a, 54 Mbps OFDM)

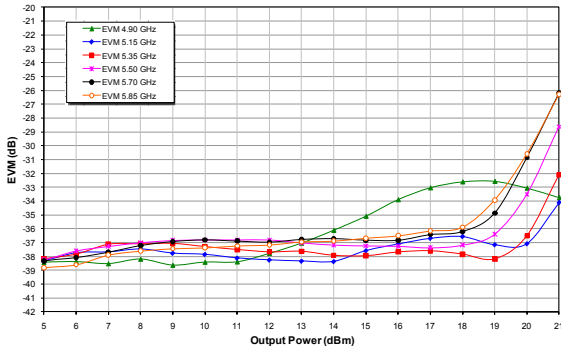

Figure 22: Tx Path Dynamic EVM vs. Output Power Across Frequency (Vcc = +3.3 V, Temp = -40 °C, 802.11a, 54 Mbps OFDM)

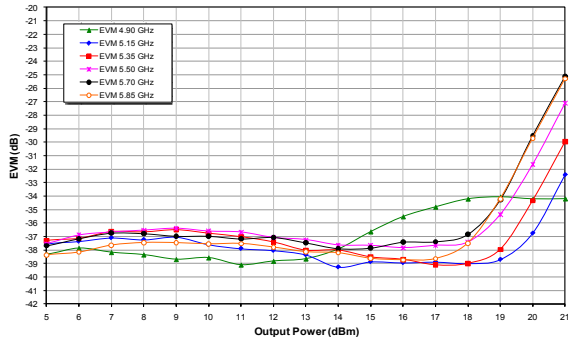

Figure 23: Tx Path Dynamic EVM vs. Output Power Across Frequency (Vcc = +3.3 V, Temp = +85 °C, 802.11a, 54 Mbps OFDM)

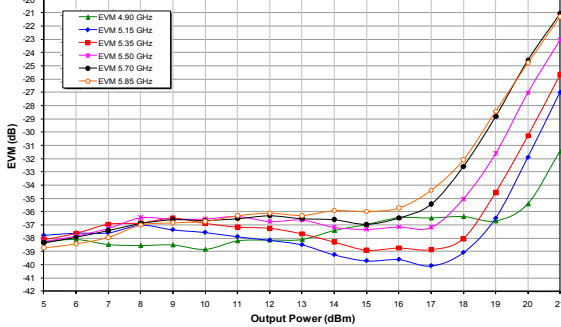

Figure 24: Voltage Detector vs. Output Power Across Frequency (Vcc = +3.3V, Temp = +25 °C 802.11a, 54 Mbps OFDM)

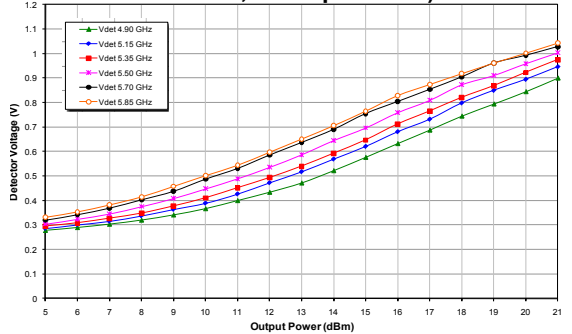

Figure 25: Voltage Detector vs. Output Power Across Voltage (Freq = 5.5 GHz, Temp = +25 °C 802.11a, 54 Mbps OFDM)

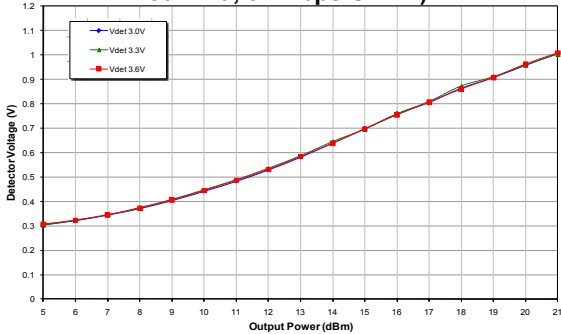

Figure 26: Voltage Detector vs. Output Power Across Temperature (Freq = 5.5 GHz, Vcc = +3.3V 802.11a, 54 Mbps OFDM)

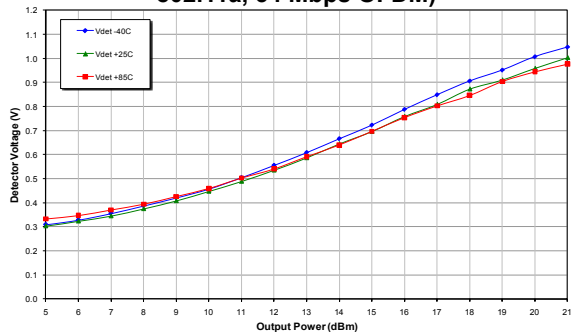

Figure 27: Voltage Detector vs. Output Power Across Frequency (Vcc = +3.0 V, Temp = +25 °C 802.11a, 54 Mbps OFDM)

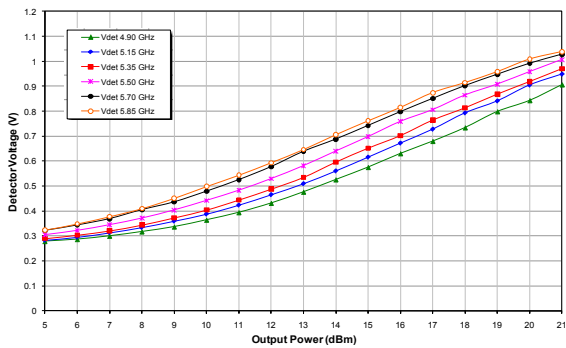

Figure 28: Voltage Detector vs. Output Power Across Frequency (Vcc = +3.6 V, Temp = +25 °C 802.11a, 54 Mbps OFDM)

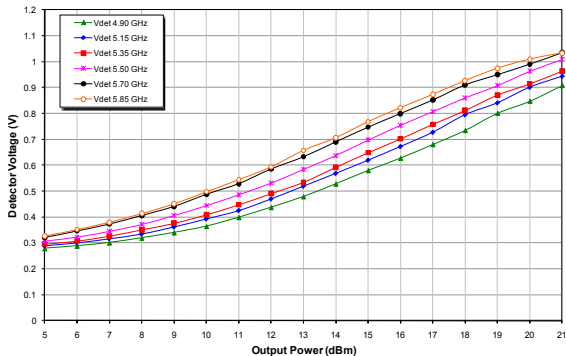

Figure 29: Voltage Detector vs. Output Power Across Frequency (Vcc = +3.3 V, Temp = -40 °C 802.11a, 54 Mbps OFDM)

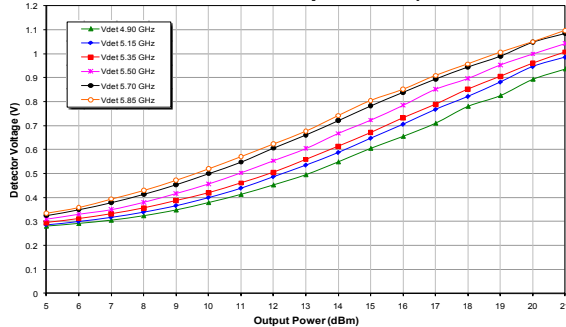

Figure 30: Voltage Detector vs. Output Power Across Frequency (Vcc = +3.3 V, Temp = +85 °C 802.11a, 54 Mbps OFDM)

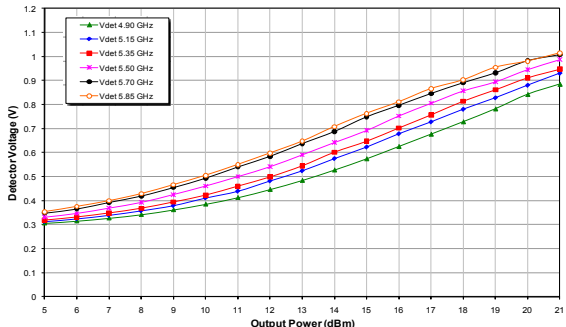

Figure 31: Tx Path S21 Response (Vcc = +3.3V, Temp = +25 °C)

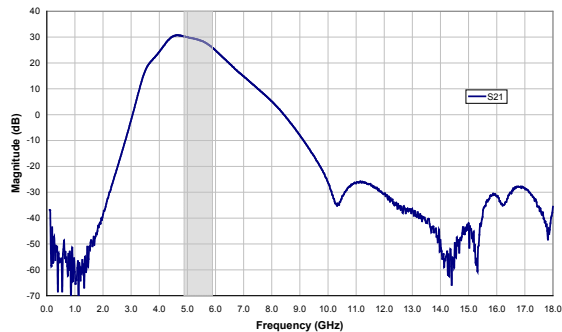
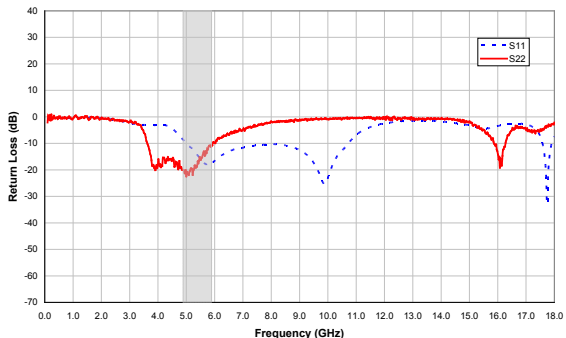

Figure 32: Tx Path S11 and S22 Return Loss (Vcc = +3.3 V, Temp = +25 °C)



APPLICATION INFORMATION

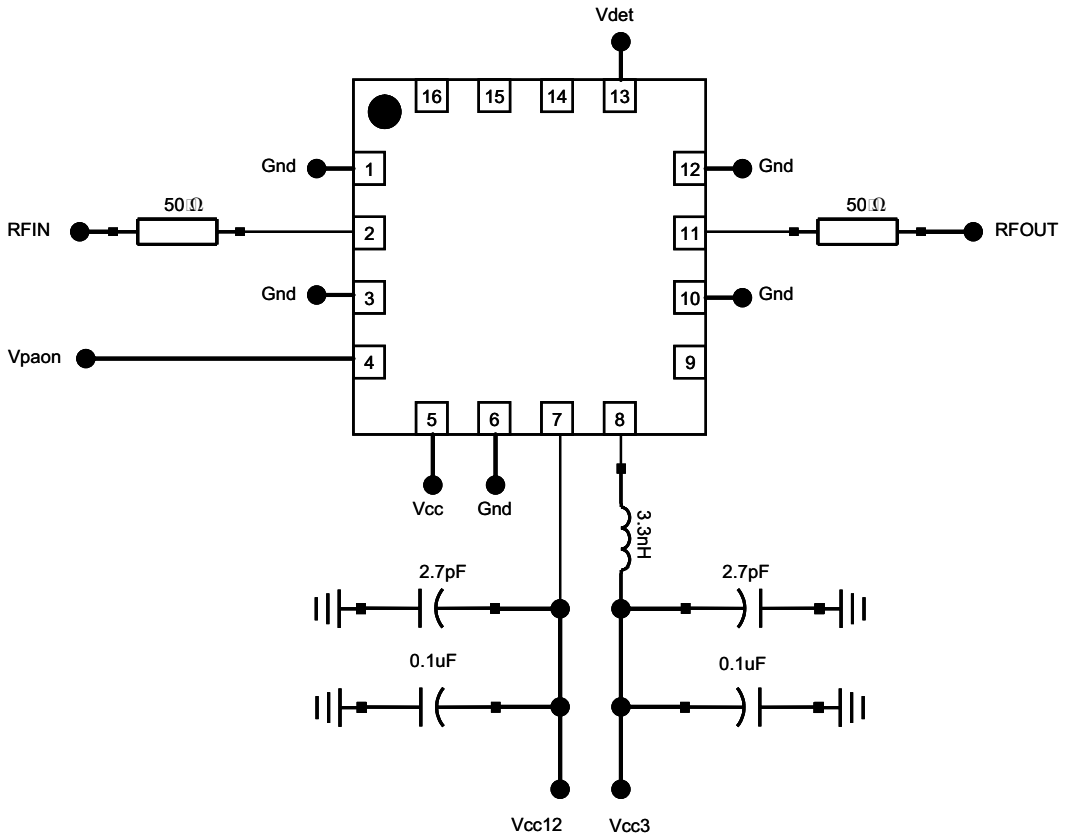
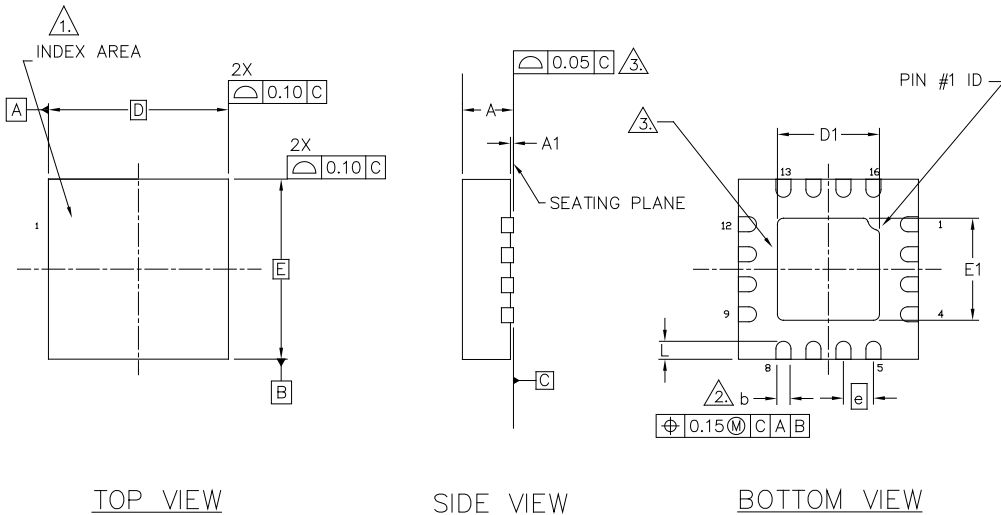

Figure 33: Application Circuit

PACKAGE OUTLINE



TOP VIEW

SIDE VIEW

BOTTOM VIEW

S V G	DIMENSIONS—MM			N _O T E	S V G	DIMENSIONS—INCHES			N _O T E
	MIN.	NOM.	MAX.			MIN.	NOM.	MAX.	
A	0.50	0.55	0.60		A	0.020	0.022	0.024	
A1	0.00	0.02	0.05		A1	0.000	0.001	0.002	
b	0.18	0.25	0.30		b	0.007	0.010	0.012	
D	3.00 BSC				D	0.118 BSC			
D1	1.50	1.65	1.80		D1	0.059	0.065	0.071	
E	3.00 BSC				E	0.118 BSC			
E1	1.50	1.65	1.80		E1	0.059	0.065	0.071	
e	0.50 BSC				e	0.020 BSC			
L	0.20	0.30	0.40		L	0.008	0.012	0.016	

NOTES :

- 1. TERMINAL #1 IDENTIFIER AND PAD NUMBERING CONVENTION SHALL CONFORM TO JESD 95-1 SPP-012.
- 2. DIMENSION b APPLIES TO METALIZED TERMINAL AND IS MEASURED BETWEEN 0.25 AND 0.30mm FROM TERMINAL TIP.
- 3. BILATERAL COPLANARITY ZONE APPLIES TO THE EXPOSED PAD AS WELL AS THE TERMINALS.

Figure 34: S35 Package Outline - 16 Pin 3 mm x 3 mm x 0.55 mm QFN

TOP BRAND

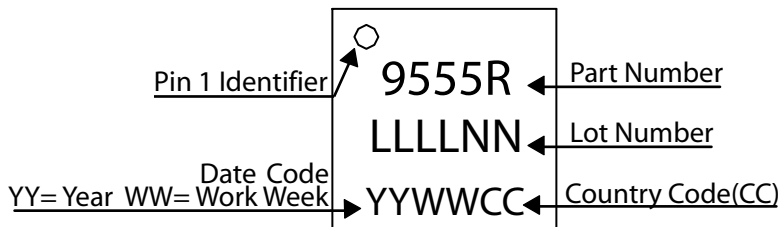
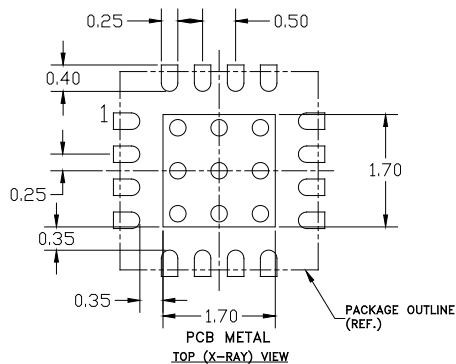

Figure 35: Branding Specification

PCB LAYOUT



NOTES:

- (1) OUTLINE DRAWING REFERENCE: 98001-TBD
- (2) UNLESS SPECIFIED DIMENSIONS ARE SYMMETRICAL ABOUT CENTER LINES SHOWN.
- (3) DIMENSIONS IN MILLIMETERS.
- (4) VIAS SHOWN IN PCB METAL VIEW ARE FOR REFERENCE ONLY. NUMBER & SIZE OF THERMAL VIAS REQUIRED DEPENDENT ON HEAT DISSIPATION REQUIREMENT AND THE PCB PROCESS CAPABILITY.
- (5) RECOMMENDED STENCIL THICKNESS: APPROX. 0.125mm (5 Mils)

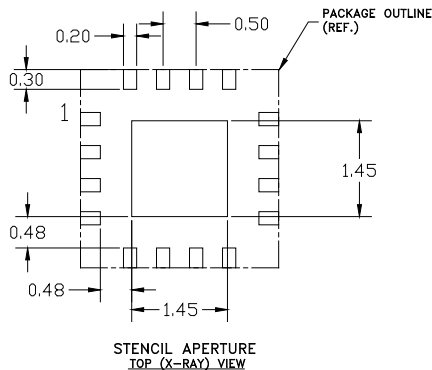
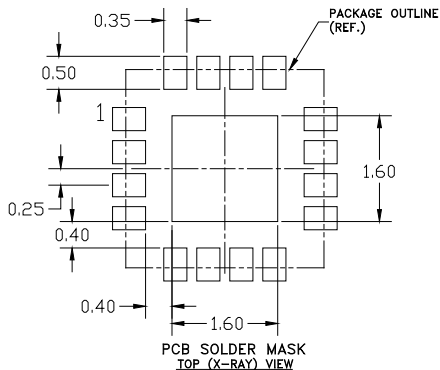

Figure 36: Recommended PCB Layout

ORDERING INFORMATION

ORDER NUMBER	TEMPERATURE RANGE	PACKAGE DESCRIPTION	COMPONENT PACKAGING
AWL9555RS35P8	-40°C to +85°C	RoHS-Compliant 16 pin 3 mm x 3 mm x 0.55 mm Surface Mount IC	2,500 piece Tape and Reel

**ANADIGICS, Inc.**

141 Mount Bethel Road
Warren, New Jersey 07059, U.S.A.

Tel: +1 (908) 668-5000

Fax: +1 (908) 668-5132

URL: <http://www.anadigics.com>

IMPORTANT NOTICE

ANADIGICS, Inc. reserves the right to make changes to its products or to discontinue any product at any time without notice. The product specifications contained in Advanced Product Information sheets and Preliminary Data Sheets are subject to change prior to a product's formal introduction. Information in Data Sheets have been carefully checked and are assumed to be reliable; however, ANADIGICS assumes no responsibilities for inaccuracies. ANADIGICS strongly urges customers to verify that the information they are using is current before placing orders.

WARNING

ANADIGICS products are not intended for use in life support appliances, devices or systems. Use of an ANADIGICS product in any such application without written consent is prohibited.