



## Device Overview

The 89HPES12N3 is a member of IDT's PRECISE™ family of PCI Express® switching solutions. The PES12N3 is a 12-lane, 3-port peripheral chip that performs PCI Express Base switching with a feature set optimized for high performance applications such as servers, storage, and communications/networking. It provides connectivity and switching functions between a PCIe® upstream port and two downstream ports or peer-to-peer switching between downstream ports.

## Features

- ◆ **High Performance PCI Express Switch**
  - Three x4 ports with 12 PCI Express lanes total
  - Delivers 6 GBps (48 Gbps) aggregate switching capacity
  - Low latency cut-through switch architecture
  - Supports 128 to 2048 byte maximum payload size
  - Supports one virtual channel
  - PCI Express Base specification Revision 1.0a compliant
- ◆ **Flexible Architecture with Numerous Configuration Options**
  - Port arbitration schemes utilizing round robin or weighted round robin algorithms
  - Supports automatic per port link with negotiation (x4, x2, or x1)
  - Supports static lane reversal on all ports
  - Supports polarity inversion
  - Supports locked transactions, allowing use with legacy software
  - Ability to load device configuration from serial EEPROM
- ◆ **Highly Integrated Solution**
  - Requires no external components
  - Incorporates on-chip internal memory for packet buffering and queueing
  - Integrates 12 2.5 Gbps embedded SerDes, 8B/10B encoder/decoder (no separate transceivers needed)
- ◆ **Reliability, Availability, and Serviceability (RAS) Features**
  - Internal end-to-end parity protection on all TLPs ensures data integrity even in systems that do not implement end-to-end CRC (ECRC)
  - Supports ECRC passed through
  - Supports PCI Express Native Hot-Plug
    - Compatible with Hot-Plug I/O expanders used on PC motherboards
  - Supports Hot-Swap
- ◆ **Power Management**
  - Supports PCI Power Management Interface specification, Revision 1.1 (PCI-PM)
  - Unused SerDes are disabled
  - Supports Advanced Configuration and Power Interface Specification, Revision 2.0 (ACPI) supporting active link state
- ◆ **Testability and Debug Features**
  - Built in SerDes Pseudo-Random Bit Stream (PRBS) generator
  - Ability to read and write any internal register via the SMBus
  - Ability to bypass link training and force any link into any mode
  - Provides statistics and performance counters

## Block Diagram

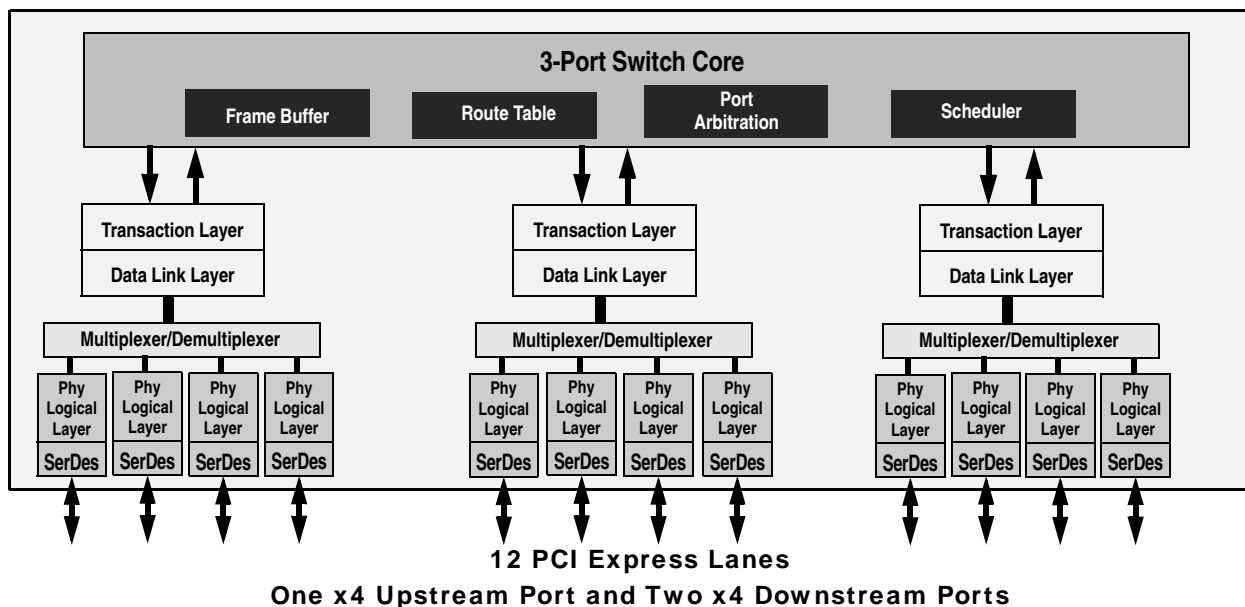

Figure 1 Internal Block Diagram

#### ◆ Two SMBus Interfaces

- Slave interface provides full access to all software-visible registers by an external SMBus master
- Master interface provides connection for an optional serial EEPROM used for initialization
- Master interface is also used by an external Hot-Plug I/O expander
- Master and slave interfaces may be tied together so the PES12N3 can act as both master and slave

#### ◆ 8 General Purpose Input/Output pins

#### ◆ Packaged in 19x19mm 324 ball BGA with 1mm ball spacing

### Product Description

Utilizing standard PCI Express interconnect, the PES12N3 provides the most efficient high-performance I/O connectivity solution for applications requiring high throughput, low latency, and simple board layout with a minimum number of board layers. It provides 6 GBps (48 Gbps) of aggregated, full-duplex switching capacity through 12 integrated serial lanes, using proven and robust IDT technology. Each lane provides 2.5 Gbps of bandwidth in both directions and is fully compliant with PCI Express Base specification 1.0a.

The PES12N3 is based on a flexible and efficient layered architecture. The PCI Express layer consists of SerDes, Physical, Data Link and Transaction layers in compliance with PCI Express Base specification Revision 1.0a. The PES12N3 can operate either as a store and forward or cut-through switch and is designed to switch memory and I/O transactions. It supports eight Traffic Classes (TCs) and one Virtual Channel (VC) with sophisticated resource management. This includes system selectable algorithms such as round robin, weighted round-robin, and strict priority schemes guaranteeing bandwidth allocation and/or latency for critical traffic classes in applications such as high throughput Quad/Dual Gigabit I/Os, SATA controllers, and Fibre Channel HBAs.

### Switch Configuration

The PES12N3 is a three port switch that contains 12 PCI Express lanes. Each of the three ports is statically allocated 4 lanes with ports labeled as A, B and C. Port A is always the upstream port while ports B and C are always downstream ports. The switch operating mode, as well as an optional initialization from a serial EEPROM, is selected via the Switch Mode (SWMODE[3:0]) inputs.

During link training, link width is automatically negotiated. Each PES12N3 port is capable of independently negotiating to a x4, x2 or x1 width. Thus, the PES12N3 may be used in virtually any three port switch configuration (e.g., {x4, x4, x4}, {x4, x2, x1}, etc.). The PES12N3 supports static lane reversal. For example, lane reversal for upstream port A may be configured by asserting the PCI Express Port A Lane Reverse (PEALREV) input signal or through serial EEPROM or SMBus initialization. Lane reversal for ports B and C may be enabled via a configuration space register, serial EEPROM, or the SMBus.

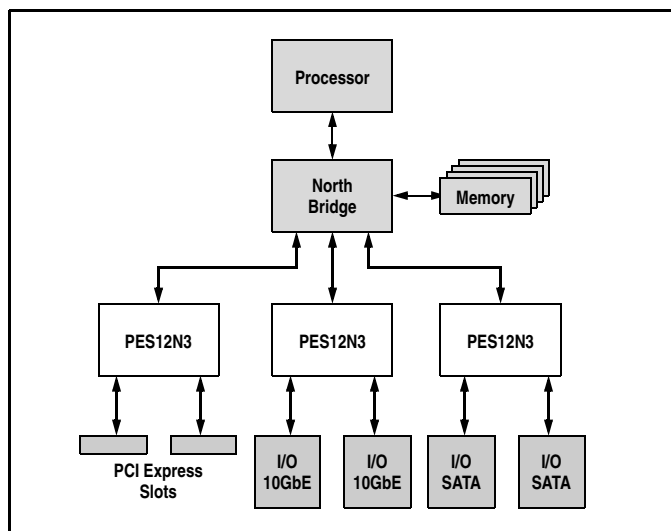

Figure 2 I/O Expansion Application

## Pin Description

The following tables list the functions of the pins provided on the PES12N3. Some of the functions listed may be multiplexed onto the same pin. The active polarity of a signal is defined using a suffix. Signals ending with an "N" are defined as being active, or asserted, when at a logic zero (low) level. All other signals (including clocks, buses, and select lines) will be interpreted as being active, or asserted, when at a logic one (high) level.

Signal	Type	Name/Description
PEALREV	I	<b>PCI Express Port A Lane Reverse.</b> When this bit is asserted, the lanes of PCI Express Port A are reversed. This value may be overridden by modifying the value of the PALREV bit in the PA_SWCTL register.
PEARP[3:0] PEARN[3:0]	I	<b>PCI Express Port A Serial Data Receive.</b> Differential PCI Express receive pairs for port A.
PEATP[3:0] PEATN[3:0]	O	<b>PCI Express Port A Serial Data Transmit.</b> Differential PCI Express transmit pairs for port A
PEBLREV	I	<b>PCI Express Port B Lane Reverse.</b> When this bit is asserted, the lanes of PCI Express Port B are reversed. This value may be overridden by modifying the value of the PBLREV bit in the PA_SWCTL register.
PEBRP[3:0] PEBRN[3:0]	I	<b>PCI Express Port B Serial Data Receive.</b> Differential PCI Express receive pairs for port B.
PEBTP[3:0] PEBTN[3:0]	O	<b>PCI Express Port B Serial Data Transmit.</b> Differential PCI Express transmit pairs for port B
PECLREV	I	<b>PCI Express Port C Lane Reverse.</b> When this bit is asserted, the lanes of PCI Express Port C are reversed. This value may be overridden by modifying the value of the PCLREV bit in the PA_SWCTL register.
PECRP[3:0] PECRN[3:0]	I	<b>PCI Express Port C Serial Data Receive.</b> Differential PCI Express receive pairs for port C.
PECTP[3:0] PECTN[3:0]	O	<b>PCI Express Port C Serial Data Transmit.</b> Differential PCI Express transmit pairs for port C
PEREFCLKP[1:0] PEREFCLKN[1:0]	I	<b>PCI Express Reference Clock.</b> Differential reference clock pair input. This clock is used as the reference clock by on-chip PLLs to generate the clocks required for the system logic and on-chip SerDes. The frequency of the differential reference clock is determined by the REFCLKM signal.
REFCLKM	I	<b>PCI Express Reference Clock Mode Select.</b> These signals select the frequency of the reference clock input. 0x0 - 100 MHz 0x1 - 125 MHz

Table 1 PCI Express Interface Pins

Signal	Type	Name/Description
MSMBADDR[4:1]	I	<b>Master SMBus Address.</b> These pins determine the SMBus address of the serial EEPROM from which configuration information is loaded.
MSMBCLK	I/O	<b>Master SMBus Clock.</b> This bidirectional signal is used to synchronize transfers on the master SMBus. This signal is active only when EEPROM data is being loaded.
MSMBDAT	I/O	<b>Master SMBus Data.</b> This bidirectional signal is used for data on the master SMBus.

Table 2 SMBus Interface Pins (Part 1 of 2)

Signal	Type	Name/Description
SSMBADDR[5,3:1]	I	<b>Slave SMBus Address.</b> These pins determine the SMBus address to which the slave SMBus interface responds.
SSMBCLK	I/O	<b>Slave SMBus Clock.</b> This bidirectional signal is used to synchronize transfers on the slave SMBus.
SSMBDAT	I/O	<b>Slave SMBus Data.</b> This bidirectional signal is used for data on the slave SMBus.

Table 2 SMBus Interface Pins (Part 2 of 2)

Signal	Type	Name/Description
GPIO[0]	I/O	<b>General Purpose I/O.</b> This pin can be configured as a general purpose I/O pin.
GPIO[1]	I/O	<b>General Purpose I/O.</b> This pin can be configured as a general purpose I/O pin.
GPIO[2]	I/O	<b>General Purpose I/O.</b> This pin can be configured as a general purpose I/O pin. Alternate function pin name: IOEXPINTN Alternate function pin type: Input Alternate function: Hot-Plug I/O expander interrupt input
GPIO[3]	I/O	<b>General Purpose I/O.</b> This pin can be configured as a general purpose I/O pin. Alternate function pin name: PAABN Alternate function pin type: Input Alternate function: Port A attention button Input
GPIO[4]	I/O	<b>General Purpose I/O.</b> This pin can be configured as a general purpose I/O pin. Alternate function pin name: PAAIN Alternate function pin type: Output Alternate function: Port A attention indicator output
GPIO[5]	I/O	<b>General Purpose I/O.</b> This pin can be configured as a general purpose I/O pin. Alternate function pin name: PAPIN Alternate function pin type: Output Alternate function: Port A power indicator output
GPIO[6]	I/O	<b>General Purpose I/O.</b> This pin can be configured as a general purpose I/O pin.
GPIO[7]	I/O	<b>General Purpose I/O.</b> This pin can be configured as a general purpose I/O pin.

Table 3 General Purpose I/O Pins

Signal	Type	Name/Description
CCLKDS	I	<b>Common Clock Downstream.</b> When the CCLKDS pin is asserted, it indicates that a common clock is being used between the downstream device and the downstream port.
CCLKUS	I	<b>Common Clock Upstream.</b> When the CCLKUS pin is asserted, it indicates that a common clock is being used between the upstream device and the upstream port.
MSMBSMODE	I	<b>Master SMBus Slow Mode.</b> The assertion of this pin indicates that the master SMBus should operate at 100 KHz instead of 400 KHz. This value may not be overridden.
PERSTN	I	<b>Fundamental Reset.</b> Assertion of this signal resets all logic inside the PES12N3 and initiates a PCI Express fundamental reset.
RSTHALT	I	<b>Reset Halt.</b> When this signal is asserted during a PCI Express fundamental reset, the PES12N3 executes the reset procedure and remains in a reset state with the Master and Slave SMBuses active. This allows software to read and write registers internal to the device before normal device operation begins. The device exits the reset state when the RSTHALT bit is cleared in the PA_SWCTL register by an SMBus master.
TSTRSVD	I	<b>Reserved.</b> Reserved for future test mode. Must be tied to ground.
SWMODE[3:0]	I	<b>Switch Mode.</b> These configuration pins determine the PES12N3 switch operating mode. 0x0 - Transparent mode 0x1 - Transparent mode with serial EEPROM initialization 0x2 through 0x7 - Reserved 0x8 - 10-bit loopback test mode 0x9 - Reserved 0xA - Internal pseudo random bit stream self-test test mode 0xB - External pseudo random bit stream self-test test mode 0xC - Reserved 0xD - SerDes broadcast test mode 0xE - 0xF Reserved

Table 4 System Pins

Signal	Type	Name/Description
JTAG_TCK	I	<b>JTAG Clock.</b> This is an input test clock used to clock the shifting of data into or out of the boundary scan logic or JTAG Controller. JTAG_TCK is independent of the system clock with a nominal 50% duty cycle.
JTAG_TDI	I	<b>JTAG Data Input.</b> This is the serial data input to the boundary scan logic or JTAG Controller.

Table 5 Test Pins (Part 1 of 2)

Signal	Type	Name/Description
JTAG_TDO	O	<b>JTAG Data Output.</b> This is the serial data shifted out from the boundary scan logic or JTAG Controller. When no data is being shifted out, this signal is tri-stated.
JTAG_TMS	I	<b>JTAG Mode.</b> The value on this signal controls the test mode select of the boundary scan logic or JTAG Controller.
JTAG_TRST_N	I	<b>JTAG Reset.</b> This active low signal asynchronously resets the boundary scan logic and JTAG TAP Controller. An external pull-up on the board is recommended to meet the JTAG specification in cases where the tester can access this signal. However, for systems running in functional mode, one of the following should occur: 1) actively drive this signal low with control logic 2) statically drive this signal low with an external pull-down on the board

Table 5 Test Pins (Part 2 of 2)

Signal	Type	Name/Description
V <sub>DD</sub> CORE	I	<b>Core V<sub>DD</sub>.</b> Power supply for core logic.
V <sub>DD</sub> IO	I	<b>I/O V<sub>DD</sub>.</b> LVTTTL I/O buffer power supply.
V <sub>DD</sub> PE	I	<b>PCI Express Digital Power.</b> PCI Express digital power used by the digital power of the SerDes.
V <sub>DD</sub> APE	I	<b>PCI Express Analog Power.</b> PCI Express analog power used by the PLL and bias generator.
V <sub>TT</sub> PE	I	<b>PCI Express Termination Power.</b>
V <sub>SS</sub>	I	Ground.

Table 6 Power and Ground Pins

## Pin Characteristics

**Note:** Some input pads of the PES12N3 do not contain internal pull-ups or pull-downs. Unused inputs should be tied off to appropriate levels. This is especially critical for unused control signal inputs which, if left floating, could adversely affect operation. Also, any input pin left floating can cause a slight increase in power consumption.

Function	Pin Name	Type	Buffer	I/O Type	Internal Resistor	Notes
PCI Express Interface	PEALREV	I	LVTTTL	Input	pull-down	
	PEARN[3:0]	I	CML	Serial link		
	PEARP[3:0]	I				
	PEATN[3:0]	O				
	PEATP[3:0]	O				
	PEBLREV	I	LVTTTL	Input	pull-down	
	PEBRN[3:0]	I	CML	Serial link		
	PEBRP[3:0]	I				
	PEBTN[3:0]	O				
	PEBTP[3:0]	O				
	PECLREV	I	LVTTTL	Input	pull-down	
	PECRN[3:0]	I	CML	Serial link		
	PECRP[3:0]	I				
	PECTN[3:0]	O				
	PECTP[3:0]	O				
	PEREFCLKN[1:0]	I	LVPECL/ CML	Diff. Clock Input		Refer to Table 8
PEREFCLKP[1:0]	I					
REFCLKM	I	LVTTTL	Input	pull-down		
SMBus	MSMBADDR[4:1]	I	LVTTTL	Input	pull-up	
	MSMBCLK	I/O		STI		
	MSMBDAT	I/O				
	SSMBADDR[5,3:1]	I		Input	pull-up	
	SSMBCLK	I/O		STI		
	SSMBDAT	I/O				
General Purpose I/O	GPIO[7:0]	I/O	LVTTTL	Input, High Drive	pull-up	

Table 7 Pin Characteristics (Part 1 of 2)

Function	Pin Name	Type	Buffer	I/O Type	Internal Resistor	Notes
System Pins	CCLKDS	I	LVTTL	Input	pull-up	
	CCLKUS	I			pull-up	
	MSMBSMODE	I			pull-down	
	PERSTN	I				
	RSTHALT	I			pull-down	
	TSTRSVD	I			pull-down	External pulldown
	SWMODE[3:0]	I			pull-up	
JTAG	JTAG_TCK	I	LVTTL	STI	pull-up	
	JTAG_TDI	I			pull-up	
	JTAG_TDO	O		Low Drive		
	JTAG_TMS	I		STI	pull-up	
	JTAG_TRST_N	I			pull-up	External pulldown

Table 7 Pin Characteristics (Part 2 of 2)

# Logic Diagram — PES12N3

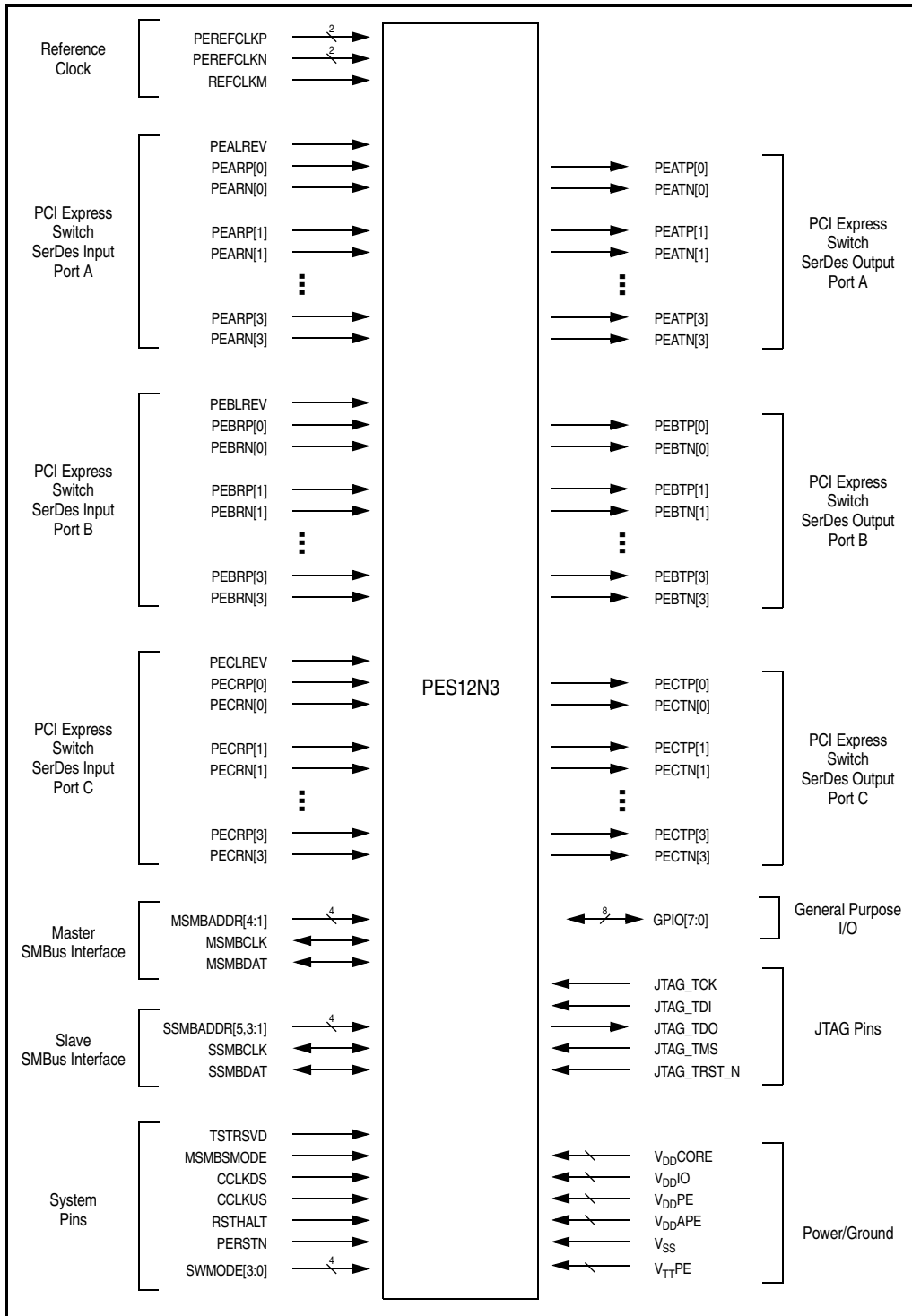

Figure 3 PES12N3 Logic Diagram

## System Clock Parameters

Values based on systems running at recommended supply voltages and operating temperatures, as shown in Tables 12 and 13.

Parameter	Description	Min	Typical	Max	Unit
Refclk <sub>FREQ</sub>	Input reference clock frequency range	100		125 <sup>1</sup>	MHz
Refclk <sub>DC</sub> <sup>2</sup>	Duty cycle of input clock	40	50	60	%
T <sub>R</sub> , T <sub>F</sub>	Rise/Fall time of input clocks			0.2*RCUI	RCUI <sup>3</sup>
V <sub>SW</sub>	Differential input voltage swing <sup>4</sup>	0.6		1.6	V
T <sub>jitter</sub>	Input clock jitter (cycle-to-cycle)			125	ps
R <sub>T</sub>	Termination Resistor		110		Ohms

**Table 8 Input Clock Requirements**

<sup>1</sup> The input clock frequency will be either 100 or 125 MHz depending on signal REFCLKM.

<sup>2</sup> ClkIn must be AC coupled. Use 0.01 — 0.1  $\mu$ F ceramic capacitors.

<sup>3</sup> RCUI (Reference Clock Unit Interval) refers to the reference clock period.

<sup>4</sup> AC coupling required.

## AC Timing Characteristics

Parameter	Description	Min <sup>1</sup>	Typical <sup>1</sup>	Max <sup>1</sup>	Units
<b>PCIe Transmit</b>					
UI	Unit Interval	399.88	400	400.12	ps
T <sub>TX-EYE</sub>	Minimum Tx Eye Width	0.7	.9		UI
T <sub>TX-EYE-MEDIAN-to-MAX-JITTER</sub>	Maximum time between the jitter median and maximum deviation from the median			0.15	UI
T <sub>TX-RISE</sub> , T <sub>TX-FALL</sub>	D+ / D- Tx output rise/fall time	50	90		ps
T <sub>TX-IDLE-MIN</sub>	Minimum time in idle	50			UI
T <sub>TX-IDLE-SET-TO-IDLE</sub>	Maximum time to transition to a valid Idle after sending an Idle ordered set			20	UI
T <sub>TX-IDLE-TO-DIFF-DATA</sub>	Maximum time to transition from valid idle to diff data			20	UI
T <sub>TX-IDLE-RCV-DET-MAX</sub>	Max time spend in idle before initiating a RX detect sequence		20	100	ms
T <sub>TX-SKEW</sub>	Transmitter data skew between any 2 lanes		500	1300	ps
<b>PCIe Receive</b>					
UI	Unit Interval	399.88	400	400.12	ps
T <sub>RX-EYE (with jitter)</sub>	Minimum Receiver Eye Width (jitter tolerance)	0.4			UI

**Table 9 PCIe AC Timing Characteristics (Part 1 of 2)**

Parameter	Description	Min <sup>1</sup>	Typical <sup>1</sup>	Max <sup>1</sup>	Units
T <sub>RX-EYE-MEDIUM TO MAX JITTER</sub>	Max time between jitter median & max deviation			0.3	UI
T <sub>RX-IDLE-DET-DIFF-ENTER TIME</sub>	Unexpected Idle Enter Detect Threshold Integration Time			10	ms
T <sub>RX-SKEW</sub>	Lane to lane input skew			20	ns

**Table 9 PCIe AC Timing Characteristics (Part 2 of 2)**

<sup>1</sup>: Minimum, Typical, and Maximum values meet the requirements under PCI Specification 1.0a

Signal	Symbol	Reference Edge	Min	Max	Unit	Timing Diagram Reference
<b>GPIO</b>						
GPIO[7:0] <sup>1</sup>	Tpw_13b <sup>2</sup>	None	50	—	ns	

**Table 10 GPIO AC Timing Characteristics**

<sup>1</sup>: GPIO signals must meet the setup and hold times if they are synchronous or the minimum pulse width if they are asynchronous.

<sup>2</sup>: The values for this symbol were determined by calculation, not by testing.

Signal	Symbol	Reference Edge	Min	Max	Unit	Timing Diagram Reference
<b>JTAG</b>						
JTAG_TCK	Tper_16a	none	50.0	—	ns	See Figure 4.
	Thigh_16a, Tlow_16a		10.0	25.0	ns	
JTAG_TMS <sup>1</sup> , JTAG_TDI	Tsu_16b	JTAG_TCK rising	2.4	—	ns	
	Thld_16b		1.0	—	ns	
JTAG_TDO	Tdo_16c	JTAG_TCK falling	—	20	ns	
	Tdz_16c <sup>2</sup>		—	20	ns	
JTAG_TRST_N	Tpw_16d <sup>2</sup>	none	25.0	—	ns	

**Table 11 JTAG AC Timing Characteristics**

<sup>1</sup>: The JTAG specification, IEEE 1149.1, recommends that JTAG\_TMS should be held at 1 while the signal applied at JTAG\_TRST\_N changes from 0 to 1. Otherwise, a race may occur if JTAG\_TRST\_N is deasserted (going from low to high) on a rising edge of JTAG\_TCK when JTAG\_TMS is low, because the TAP controller might go to either the Run-Test/Idle state or stay in the Test-Logic-Reset state.

<sup>2</sup>: The values for this symbol were determined by calculation, not by testing.

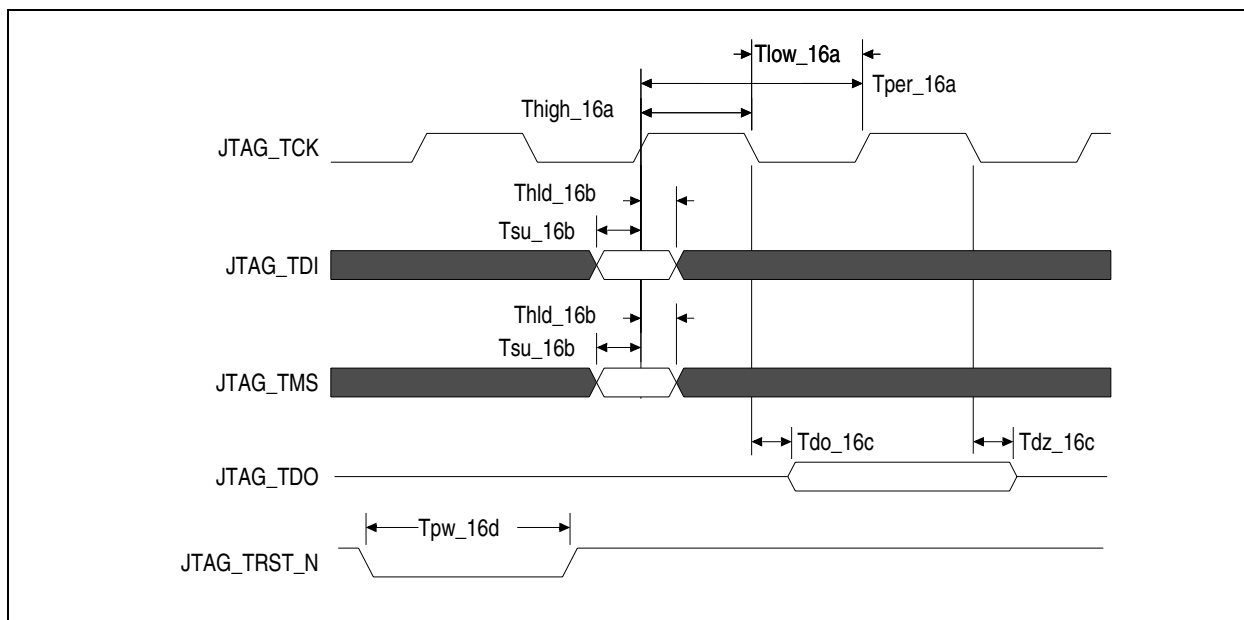

Figure 4 JTAG AC Timing Waveform

## Recommended Operating Supply Voltages

Symbol	Parameter	Minimum	Typical	Maximum	Unit
V <sub>DD</sub> CORE	Internal logic supply	0.9	1.0	1.1	V
V <sub>DD</sub> I/O	I/O supply except for SerDes LVPECL/CML	3.135	3.3	3.465	V
V <sub>DD</sub> PE	PCI Express Digital Power	0.9	1.0	1.1	V
V <sub>DD</sub> APE	PCI Express Analog Power	0.9	1.0	1.1	V
V <sub>TT</sub> PE	PCI Express Serial Data Transmit Termination Voltage	1.425	1.5	1.575	V
V <sub>SS</sub>	Common ground	0	0	0	V

Table 12 PES12N3 Operating Voltages

## Recommended Operating Temperature

Grade	Temperature
Commercial	0°C to +70°C Ambient

Table 13 PES12N3 Operating Temperatures

## Power-Up Sequence

This section describes the sequence in which various voltages must be applied to the part during power-up to ensure proper functionality. For the PES12N3, the power-up sequence must be as follows:

1.  $V_{DD}I/O$  — 3.3V
2.  $V_{DD}Core$ ,  $V_{DD}PE$ ,  $V_{DD}APE$  — 1.0V
3.  $V_{TT}PE$  — 1.5V

When powering up, each voltage level must ramp and stabilize prior to applying the next voltage in the sequence to ensure internal latch-up issues are avoided. There are no maximum time limitations in ramping to valid power levels. The power-down sequence must be in the reverse order of the power-up sequence.

## Power Consumption

Typical power is measured under the following conditions: 25°C Ambient, 35% total link usage on all ports, typical voltages defined in Table 14.

Maximum power is measured under the following conditions: 70°C Ambient, 85% total link usage on all ports, maximum voltages defined in Table 14.

All power measurements assume that the part is mounted on a 10 layer printed circuit board with 0 LFM airflow.

Number of Connected Lanes: Port-A/Port-B/Port-C	Core (Watts) (1.0V supply)		PCIe Digital (Watts) (1.0V supply)		PCIe Analog (Watts) (1.0V supply)		PCIe Termin- ation (Watts) (1.5V supply)		I/O (Watts) (3.3V supply)		Total (Watts)	
	Typ	Max	Typ	Max	Typ	Max	Typ	Max	Typ	Max	Typ	Max
1/1/1	0.52	0.67	0.27	0.36	0.13	0.16	0.11	0.13	0.01	0.01	1.04	1.33
4/1/1	0.56	0.76	0.47	0.58	0.19	0.21	0.22	0.26	0.01	0.01	1.44	1.81
4/4/4	0.65	0.89	0.68	0.81	0.21	0.25	0.38	0.51	0.01	0.01	1.92	2.47

Table 14 PES12N3 Power Consumption

## DC Electrical Characteristics

Values based on systems running at recommended supply voltages, as shown in Table 12.

**Note:** See Table 7, Pin Characteristics, for a complete I/O listing.

I/O Type	Parameter	Description	Min <sup>1</sup>	Typ <sup>1</sup>	Max <sup>1</sup>	Unit	Conditions
Serial Link	<b>PCIe Transmit</b>						
	V <sub>TX-DIFFp-p</sub>	Differential peak-to-peak output voltage	800		1200	mV	
	V <sub>TX-DE-RATIO</sub>	De-emphasized differential output voltage	-3		-4	dB	
	V <sub>TX-DC-CM</sub>	DC Common mode voltage	-0.1	1	3.7	V	
	V <sub>TX-CM-ACP</sub>	RMS AC peak common mode output voltage			20	mV	
	V <sub>TX-CM-DC-active-idle-delta</sub>	Abs delta of DC common mode voltage between L0 and idle			100	mV	
	V <sub>TX-CM-DC-line-delta</sub>	Abs delta of DC common mode voltage between D+ and D-			25	mV	
	V <sub>TX-Idle-DiffP</sub>	Electrical idle diff peak output			20	mV	
	V <sub>TX-RCV-Detect</sub>	Voltage change during receiver detection			600	mV	
	RL <sub>TX-DIFF</sub>	Transmitter Differential Return loss	12			dB	
	RL <sub>TX-CM</sub>	Transmitter Common Mode Return loss	6			dB	
	Z <sub>TX-DEFF-DC</sub>	DC Differential TX impedance	80	100	120	Ω	
	Z <sub>OSE</sub>	Single ended TX Impedance	40	50	60	Ω	
	Transmitter Eye Diagram	TX Eye Height (De-emphasized bits)	505	650		mV	
	Transmitter Eye Diagram	TX Eye Height (Transition bits)	800	950		mV	
	<b>PCIe Receive</b>						
	V <sub>RX-DIFFp-p</sub>	Differential input voltage (peak-to-peak)	175		1200	mV	
	V <sub>RX-CM-AC</sub>	Receiver common-mode voltage for AC coupling			150	mV	
	RL <sub>RX-DIFF</sub>	Receiver Differential Return Loss	15			dB	
	RL <sub>RX-CM</sub>	Receiver Common Mode Return Loss	6			dB	
Z <sub>RX-DIFF-DC</sub>	Differential input impedance (DC)	80	100	120	Ω		
Z <sub>RX-COMM-DC</sub>	Single-ended input impedance	40	50	60	Ω		
Z <sub>RX-COMM-HIGH-Z-DC</sub>	Powered down input common mode impedance (DC)	200k	350k		Ω		
V <sub>RX-IDLE-DET-DIFFp-p</sub>	Electrical idle detect threshold	65		175	mV		
<b>PCIe REFCLK</b>							
	C <sub>IN</sub>	Input Capacitance	1.5	—		pF	

Table 15 DC Electrical Characteristics (Part 1 of 2)

I/O Type	Parameter	Description	Min <sup>1</sup>	Typ <sup>1</sup>	Max <sup>1</sup>	Unit	Conditions
<b>Other I/Os</b>							
LOW Drive Output	I <sub>OL</sub>		—	2.5	—	mA	V <sub>OL</sub> = 0.4v
	I <sub>OH</sub>		—	-5.5	—	mA	V <sub>OH</sub> = 1.5V
High Drive Output	I <sub>OL</sub>		—	12.0	—	mA	V <sub>OL</sub> = 0.4v
	I <sub>OH</sub>		—	-20.0	—	mA	V <sub>OH</sub> = 1.5V
Schmitt Trigger Input (STI)	V <sub>IL</sub>		-0.3	—	0.8	V	—
	V <sub>IH</sub>		2.0	—	V <sub>DD</sub> I/O + 0.5	V	—
Input	V <sub>IL</sub>		-0.3	—	0.8	V	—
	V <sub>IH</sub>		2.0	—	V <sub>DD</sub> I/O + 0.5	V	—
Capacitance	C <sub>IN</sub>		—	—	8.5	pF	—
Leakage	Inputs		—	—	± 10	μA	V <sub>DD</sub> I/O (max)
	I/O <sub>LEAK</sub> w/o Pull-ups/downs		—	—	± 10	μA	V <sub>DD</sub> I/O (max)
	I/O <sub>LEAK</sub> WITH Pull-ups/downs		—	—	± 80	μA	V <sub>DD</sub> I/O (max)

Table 15 DC Electrical Characteristics (Part 2 of 2)

<sup>1</sup>: Minimum, Typical, and Maximum values meet the requirements under PCI Specification 1.0a.

## Package Pinout — 324-BGA Signal Pinout for PES12N3

The following table lists the pin numbers and signal names for the PES12N3 device.

Pin	Function	Alt	Pin	Function	Alt	Pin	Function	Alt	Pin	Function	Alt
A1	V <sub>SS</sub>		E10	V <sub>DD</sub> PE		K1	V <sub>DD</sub> CORE		P10	V <sub>DD</sub> IO	
A2	V <sub>SS</sub>		E11	V <sub>SS</sub>		K2	V <sub>SS</sub>		P11	V <sub>DD</sub> IO	
A3	PEARP03		E12	V <sub>DD</sub> PE		K3	V <sub>TT</sub> PE		P12	V <sub>DD</sub> IO	
A4	V <sub>DD</sub> CORE		E13	V <sub>SS</sub>		K4	V <sub>DD</sub> CORE		P13	V <sub>DD</sub> IO	
A5	PEATN03		E14	V <sub>DD</sub> CORE		K5	V <sub>DD</sub> PE		P14	V <sub>DD</sub> IO	
A6	V <sub>DD</sub> CORE		E15	V <sub>DD</sub> APE		K6	V <sub>SS</sub>		P15	V <sub>SS</sub>	
A7	PEATP02		E16	V <sub>SS</sub>		K7	V <sub>SS</sub>		P16	V <sub>TT</sub> PE	
A8	V <sub>DD</sub> CORE		E17	PECTP03		K8	V <sub>SS</sub>		P17	V <sub>SS</sub>	
A9	PEARNO2		E18	PECTN03		K9	V <sub>SS</sub>		P18	V <sub>DD</sub> CORE	
A10	V <sub>DD</sub> CORE		F1	V <sub>DD</sub> CORE		K10	V <sub>SS</sub>		R1	PEBTN03	
A11	PEARP01		F2	V <sub>SS</sub>		K11	V <sub>SS</sub>		R2	PEBTP03	
A12	V <sub>DD</sub> CORE		F3	V <sub>DD</sub> CORE		K12	V <sub>SS</sub>		R3	V <sub>SS</sub>	
A13	PEATP01		F4	V <sub>DD</sub> APE		K13	V <sub>SS</sub>		R4	V <sub>DD</sub> IO	
A14	V <sub>DD</sub> CORE		F5	V <sub>SS</sub>		K14	V <sub>SS</sub>		R5	V <sub>SS</sub>	
A15	V <sub>DD</sub> CORE		F6	V <sub>DD</sub> CORE		K15	V <sub>DD</sub> PE		R6	V <sub>DD</sub> CORE	
A16	PEATN00		F7	V <sub>SS</sub>		K16	V <sub>TT</sub> PE		R7	MSMBDAT	
A17	V <sub>SS</sub>		F8	V <sub>DD</sub> CORE		K17	V <sub>SS</sub>		R8	SSMBADDR_5	
A18	V <sub>SS</sub>		F9	V <sub>SS</sub>		K18	V <sub>DD</sub> CORE		R9	PEALREV	
B1	V <sub>DD</sub> CORE		F10	V <sub>DD</sub> CORE		L1	PEBRN02		R10	SWMODE_2	
B2	V <sub>DD</sub> CORE		F11	V <sub>SS</sub>		L2	PEBRP02		R11	RSTHALT	
B3	PEARNO3		F12	V <sub>SS</sub>		L3	V <sub>SS</sub>		R12	GPIO_04	1
B4	V <sub>SS</sub>		F13	V <sub>DD</sub> PE		L4	V <sub>DD</sub> PE		R13	V <sub>DD</sub> CORE	
B5	PEATP03		F14	V <sub>SS</sub>		L5	V <sub>SS</sub>		R14	V <sub>SS</sub>	
B6	V <sub>SS</sub>		F15	V <sub>DD</sub> IO		L6	V <sub>DD</sub> CORE		R15	V <sub>DD</sub> IO	
B7	PEATN02		F16	V <sub>SS</sub>		L7	V <sub>DD</sub> CORE		R16	V <sub>SS</sub>	
B8	V <sub>SS</sub>		F17	V <sub>SS</sub>		L8	V <sub>DD</sub> CORE		R17	PECTP00	
B9	PEARP02		F18	V <sub>DD</sub> CORE		L9	V <sub>DD</sub> CORE		R18	PECTN00	
B10	V <sub>SS</sub>		G1	PEBTP01		L10	V <sub>DD</sub> CORE		T1	V <sub>DD</sub> CORE	
B11	PEARNO1		G2	PEBTN01		L11	V <sub>DD</sub> CORE		T2	V <sub>SS</sub>	
B12	V <sub>SS</sub>		G3	V <sub>SS</sub>		L12	V <sub>DD</sub> CORE		T3	V <sub>SS</sub>	
B13	PEATN01		G4	V <sub>DD</sub> PE		L13	V <sub>DD</sub> CORE		T4	JTAG_TCK	
B14	V <sub>SS</sub>		G5	V <sub>DD</sub> APE		L14	V <sub>SS</sub>		T5	JTAG_TDO	
B15	V <sub>SS</sub>		G6	V <sub>SS</sub>		L15	V <sub>DD</sub> PE		T6	MSMBADDR_1	
B16	PEATP00		G7	V <sub>SS</sub>		L16	V <sub>SS</sub>		T7	MSMBCLK	

Table 16 PES12N3 324-pin Signal Pin-Out (Part 1 of 3)

Pin	Function	Alt	Pin	Function	Alt	Pin	Function	Alt	Pin	Function	Alt
B17	V <sub>DD</sub> CORE		G8	V <sub>DD</sub> IO		L17	PECRP01		T8	SSMBADDR_2	
B18	V <sub>DD</sub> CORE		G9	V <sub>SS</sub>		L18	PECRN01		T9	CCLKDS	
C1	PEBRP00		G10	V <sub>DD</sub> IO		M1	V <sub>DD</sub> CORE		T10	SWMODE_1	
C2	PEBRN00		G11	V <sub>SS</sub>		M2	V <sub>SS</sub>		T11	PERSTN	
C3	V <sub>SS</sub>		G12	V <sub>DD</sub> CORE		M3	V <sub>SS</sub>		T12	GPIO_03	1
C4	V <sub>DD</sub> CORE		G13	V <sub>SS</sub>		M4	V <sub>DD</sub> APE		T13	GPIO_07	
C5	V <sub>SS</sub>		G14	V <sub>DD</sub> APE		M5	V <sub>SS</sub>		T14	TSTRSVD	
C6	V <sub>TT</sub> PE		G15	V <sub>DD</sub> PE		M6	V <sub>DD</sub> CORE		T15	REFCLKM	
C7	V <sub>SS</sub>		G16	V <sub>SS</sub>		M7	V <sub>SS</sub>		T16	V <sub>SS</sub>	
C8	V <sub>TT</sub> PE		G17	PECTN02		M8	V <sub>SS</sub>		T17	V <sub>SS</sub>	
C9	V <sub>SS</sub>		G18	PECTP02		M9	V <sub>DD</sub> CORE		T18	V <sub>DD</sub> CORE	
C10	V <sub>TT</sub> PE		H1	V <sub>DD</sub> CORE		M10	V <sub>DD</sub> CORE		U1	PEBRP03	
C11	V <sub>SS</sub>		H2	V <sub>SS</sub>		M11	V <sub>SS</sub>		U2	PEBRN03	
C12	V <sub>TT</sub> PE		H3	V <sub>TT</sub> PE		M12	V <sub>SS</sub>		U3	V <sub>SS</sub>	
C13	V <sub>DD</sub> CORE		H4	V <sub>DD</sub> APE		M13	V <sub>DD</sub> CORE		U4	JTAG_TDI	
C14	PEARP00		H5	V <sub>SS</sub>		M14	V <sub>SS</sub>		U5	JTAG_TMS	
C15	PEARN00		H6	V <sub>SS</sub>		M15	V <sub>DD</sub> APE		U6	MSMBADDR_2	
C16	V <sub>DD</sub> CORE		H7	V <sub>DD</sub> CORE		M16	V <sub>SS</sub>		U7	MSMBADDR_4	
C17	PECRN03		H8	V <sub>SS</sub>		M17	V <sub>SS</sub>		U8	SSMBADDR_3	
C18	PECRP03		H9	V <sub>DD</sub> CORE		M18	V <sub>DD</sub> CORE		U9	CCLKUS	
D1	V <sub>DD</sub> CORE		H10	V <sub>DD</sub> CORE		N1	PEBTP02		U10	SWMODE_0	
D2	V <sub>SS</sub>		H11	V <sub>SS</sub>		N2	PEBTN02		U11	PECLREV	
D3	V <sub>SS</sub>		H12	V <sub>DD</sub> CORE		N3	V <sub>TT</sub> PE		U12	GPIO_00	
D4	V <sub>DD</sub> CORE		H13	V <sub>SS</sub>		N4	V <sub>DD</sub> APE		U13	GPIO_02	1
D5	V <sub>SS</sub>		H14	V <sub>DD</sub> APE		N5	V <sub>SS</sub>		U14	GPIO_06	
D6	V <sub>DD</sub> APE		H15	V <sub>DD</sub> PE		N6	V <sub>SS</sub>		U15	MSMBSMODE	
D7	V <sub>SS</sub>		H16	V <sub>TT</sub> PE		N7	V <sub>SS</sub>		U16	V <sub>SS</sub>	
D8	V <sub>DD</sub> APE		H17	V <sub>SS</sub>		N8	V <sub>SS</sub>		U17	PECRN00	
D9	V <sub>SS</sub>		H18	V <sub>DD</sub> CORE		N9	V <sub>SS</sub>		U18	PECRP00	
D10	V <sub>DD</sub> APE		J1	PEBRP01		N10	V <sub>SS</sub>		V1	V <sub>DD</sub> CORE	
D11	V <sub>SS</sub>		J2	PEBRN01		N11	V <sub>SS</sub>		V2	V <sub>SS</sub>	
D12	V <sub>DD</sub> APE		J3	V <sub>SS</sub>		N12	V <sub>SS</sub>		V3	PEREFCLKP1	
D13	V <sub>SS</sub>		J4	V <sub>DD</sub> PE		N13	V <sub>SS</sub>		V4	PEREFCLKN1	
D14	V <sub>DD</sub> CORE		J5	V <sub>SS</sub>		N14	V <sub>SS</sub>		V5	JTAG_TRST_N	
D15	V <sub>SS</sub>		J6	V <sub>DD</sub> CORE		N15	V <sub>DD</sub> APE		V6	MSMBADDR_3	
D16	V <sub>SS</sub>		J7	V <sub>SS</sub>		N16	V <sub>TT</sub> PE		V7	SSMBADDR_1	
D17	V <sub>SS</sub>		J8	V <sub>SS</sub>		N17	PECTN01		V8	SSMBCLK	

Table 16 PES12N3 324-pin Signal Pin-Out (Part 2 of 3)

Pin	Function	Alt	Pin	Function	Alt	Pin	Function	Alt	Pin	Function	Alt
D18	V <sub>DD</sub> CORE		J9	V <sub>DD</sub> CORE		N18	PECTP01		V9	SSMBDAT	
E1	PEBTN00		J10	V <sub>DD</sub> CORE		P1	V <sub>DD</sub> CORE		V10	PEBLREV	
E2	PEBTP00		J11	V <sub>SS</sub>		P2	V <sub>SS</sub>		V11	SWMODE_3	
E3	V <sub>DD</sub> CORE		J12	V <sub>SS</sub>		P3	V <sub>TT</sub> PE		V12	V <sub>DD</sub> IO	
E4	V <sub>SS</sub>		J13	V <sub>DD</sub> CORE		P4	V <sub>SS</sub>		V13	GPIO_01	
E5	V <sub>DD</sub> CORE		J14	V <sub>SS</sub>		P5	V <sub>DD</sub> IO		V14	GPIO_05	1
E6	V <sub>SS</sub>		J15	V <sub>DD</sub> CORE		P6	V <sub>DD</sub> IO		V15	PEREFCLKP2	
E7	V <sub>SS</sub>		J16	V <sub>SS</sub>		P7	V <sub>DD</sub> IO		V16	PEREFCLKN2	
E8	V <sub>DD</sub> PE		J17	PECRP02		P8	V <sub>DD</sub> IO		V17	V <sub>SS</sub>	
E9	V <sub>SS</sub>		J18	PECRN02		P9	V <sub>DD</sub> IO		V18	V <sub>DD</sub> CORE	

Table 16 PES12N3 324-pin Signal Pin-Out (Part 3 of 3)

### Alternate Signal Functions

Pin	GPIO	Alternate
U13	GPIO[2]	IOEXPINTN
T12	GPIO[3]	PAABN
R12	GPIO[4]	PAAIN
V14	GPIO[5]	PAPIN

Table 17 PES12N3 Alternate Signal Functions

## Power Pins

V <sub>DD</sub> Core	V <sub>DD</sub> Core	V <sub>DD</sub> Core	V <sub>DD</sub> IO	V <sub>DD</sub> PE	V <sub>DD</sub> APE	V <sub>TT</sub> PE
A4	F3	L8	F15	E8	D6	C6
A6	F6	L9	G8	E10	D8	C8
A8	F8	L10	G10	E12	D10	C10
A10	F10	L11	P5	F13	D12	C12
A12	F18	L12	P6	G4	E15	H3
A14	G12	L13	P7	G15	F4	H16
A15	H1	M1	P8	H15	G5	K3
B1	H7	M6	P9	J4	G14	K16
B2	H9	M9	P10	K5	H4	N3
B17	H10	M10	P11	K15	H14	N16
B18	H12	M13	P12	L4	M4	P3
C4	H18	M18	P13	L15	M15	P16
C13	J6	P1	P14		N4	
C16	J9	P18	R4		N15	
D1	J10	R6	R15			
D4	J13	R13	V12			
D14	J15	T1				
D18	K1	T18				
E3	K4	V1				
E5	K18	V18				
E14	L6					
F1	L7					

Table 18 PES12N3 Power Pins

## Ground Pins

$V_{SS}$	$V_{SS}$	$V_{SS}$	$V_{SS}$	$V_{SS}$
A1	D15	G11	K10	N8
A2	D16	G13	K11	N9
A17	D17	G16	K12	N10
A18	E4	H2	K13	N11
B4	E6	H5	K14	N12
B6	E7	H6	K17	N13
B8	E9	H8	L3	N14
B10	E11	H11	L5	P2
B12	E13	H13	L14	P4
B14	E16	H17	L16	P15
B15	F2	J3	M2	P17
C3	F5	J5	M3	R3
C5	F7	J7	M5	R5
C7	F9	J8	M7	R14
C9	F11	J11	M8	R16
C11	F12	J12	M11	T2
D2	F14	J14	M12	T3
D3	F16	J16	M14	T16
D5	F17	K2	M16	T17
D7	G3	K6	M17	U3
D9	G6	K7	N5	U16
D11	G7	K8	N6	V2
D13	G9	K9	N7	V17

Table 19 PES12N3 Ground Pins

## Signals Listed Alphabetically

Signal Name	I/O Type	Location	Signal Category	
CCLKDS	I	T9	System	
CCLKUS	I	U9		
GPIO_00	I/O	U12	General Purpose Input/Output	
GPIO_01	I/O	V13		
GPIO_02	I/O	U13		
GPIO_03	I/O	T12		
GPIO_04	I/O	R12		
GPIO_05	I/O	V14		
GPIO_06	I/O	U14		
GPIO_07	I/O	T13		
JTAG_TCK	I	T4		JTAG
JTAG_TDI	I	U4		
JTAG_TDO	O	T5		
JTAG_TMS	I	U5		
JTAG_TRST_N	I	V5		
MSMBADDR_1	I	T6	SMBus	
MSMBADDR_2	I	U6		
MSMBADDR_3	I	V6		
MSMBADDR_4	I	U7		
MSMBCLK	I/O	T7		
MSMBDAT	I/O	R7		
MSMBSMODE	I	U15	System	
PEALREV	I	R9	PCI Express	
PEARN00	I	C15		
PEARN01	I	B11		
PEARN02	I	A9		
PEARN03	I	B3		
PEARP00	I	C14		
PEARP01	I	A11		
PEARP02	I	B9		
PEARP03	I	A3		
PEATN00	O	A16		
PEATN01	O	B13		
PEATN02	O	B7		

Table 20 PES12N3 Alphabetical Signal List (Part 1 of 3)

Signal Name	I/O Type	Location	Signal Category
PEATN03	O	A5	PCI Express
PEATP00	O	B16	
PEATP01	O	A13	
PEATP02	O	A7	
PEATP03	O	B5	
PEBLREV	I	V10	
PEBRN00	I	C2	
PEBRN01	I	J2	
PEBRN02	I	L1	
PEBRN03	I	U2	
PEBRP00	I	C1	
PEBRP01	I	J1	
PEBRP02	I	L2	
PEBRP03	I	U1	
PEBTN00	O	E1	
PEBTN01	O	G2	
PEBTN02	O	N2	
PEBTN03	O	R1	
PEBTP00	O	E2	
PEBTP01	O	G1	
PEBTP02	O	N1	
PEBTP03	O	R2	
PECLREV	I	U11	
PECRN00	I	U17	
PECRN01	I	L18	
PECRN02	I	J18	
PECRN03	I	C17	
PECRP00	I	U18	
PECRP01	I	L17	
PECRP02	I	J17	
PECRP03	I	C18	
PECTN00	O	R18	
PECTN01	O	N17	
PECTN02	O	G17	
PECTN03	O	E18	
PECTP00	O	R17	

Table 20 PES12N3 Alphabetical Signal List (Part 2 of 3)

Signal Name	I/O Type	Location	Signal Category
PECTP01	O	N18	PCI Express
PECTP02	O	G18	
PECTP03	O	E17	
PEREFCLKN1	I	V4	PCI Express
PEREFCLKN2	I	V16	
PEREFCLKP1	I	V3	
PEREFCLKP2	I	V15	
PERSTN	I	T11	System
REFCLKM	I	T15	PCI Express
RSTHALT	I	R11	System
SSMBADDR_1	I	V7	SMBus
SSMBADDR_2	I	T8	
SSMBADDR_3	I	U8	
SSMBADDR_5	I	R8	
TSTRSVD	I	T14	System
SSMBCLK	I/O	V8	SMBus
SSMBDAT	I/O	V9	
SWMODE_0	I	U10	System
SWMODE_1	I	T10	
SWMODE_2	I	R10	
SWMODE_3	I	V11	System
V <sub>DD</sub> CORE, V <sub>DD</sub> APE, V <sub>DD</sub> IO, V <sub>DD</sub> PE, V <sub>TT</sub> PE	See Table 18 for a listing of power pins.		
V <sub>SS</sub>	See Table 19 for a listing of ground pins.		

Table 20 PES12N3 Alphabetical Signal List (Part 3 of 3)

### PES12N3 Pinout — Top View

	1	2	3	4	5	6	7	8	9	10	11	12	13	14	15	16	17	18
A																		
B																		
C																		
D																		
E																		
F																		
G																		
H																		
J																		
K																		
L																		
M																		
N																		
P																		
R																		
T																		
U																		
V																		

	V <sub>DD</sub> Core (Power)		V <sub>TT</sub> PE (Power)		Vss (Ground)		Signals
	V <sub>DD</sub> I/O (Power)		V <sub>DD</sub> PE (Power)				
			V <sub>DD</sub> APE (Power)				

# PES12N3 Package Drawing — 324-Pin BC324/BCG324

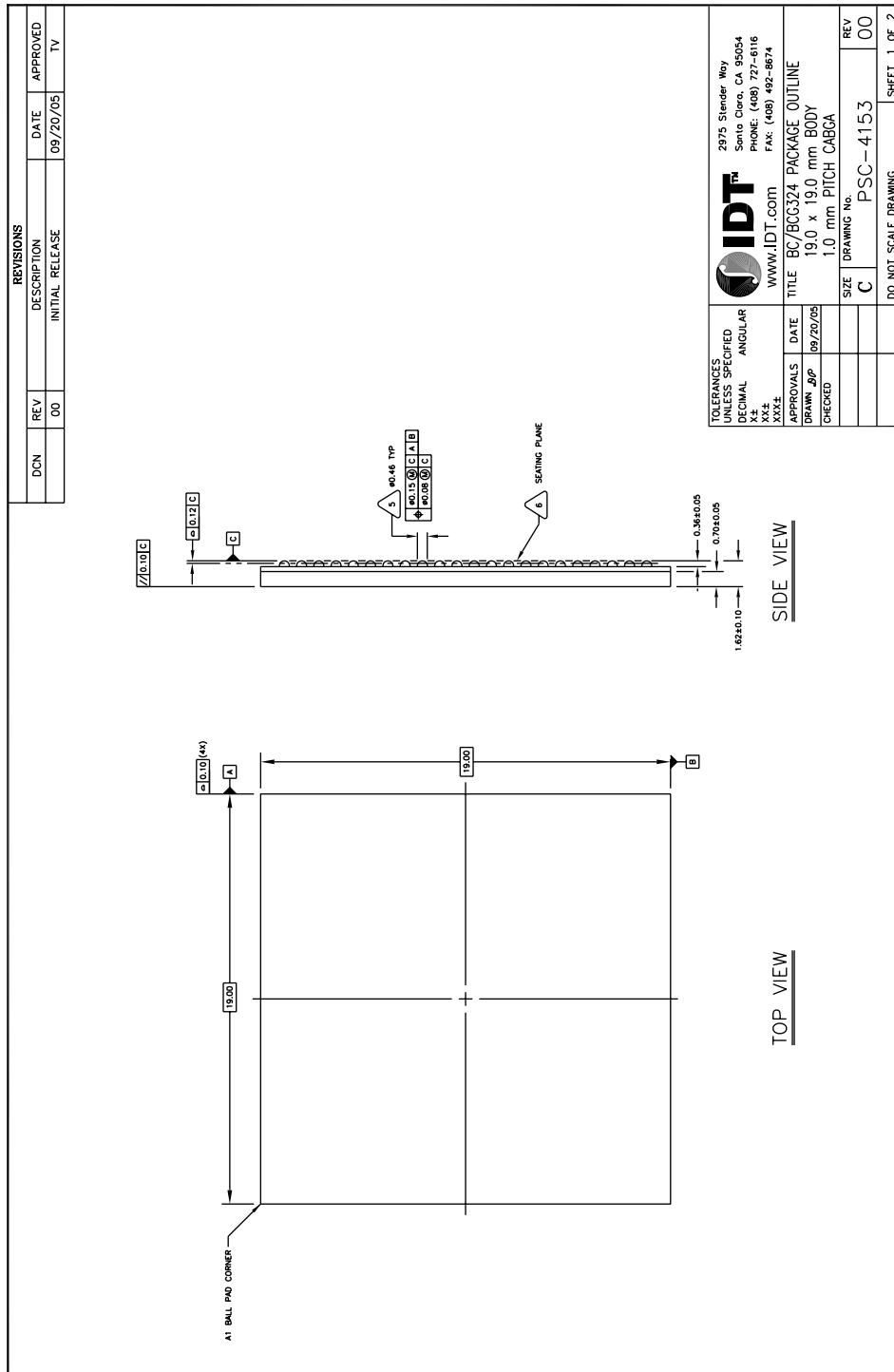

<b>IDT™</b>		2975 Slender Way Santa Clara, CA 95054 PHONE: (408) 727-6116 FAX: (408) 492-8874	
www.IDT.com		TITLE BC/BCG324 PACKAGE OUTLINE	
APPROVALS		DATE	
DRAWN JPP		09/20/05	
CHECKED		REV	
DRAWING No.		PSC-4153	
DO NOT SCALE DRAWING		SHEET 1 OF 2	

PES12N3 Package Drawing — Page Two

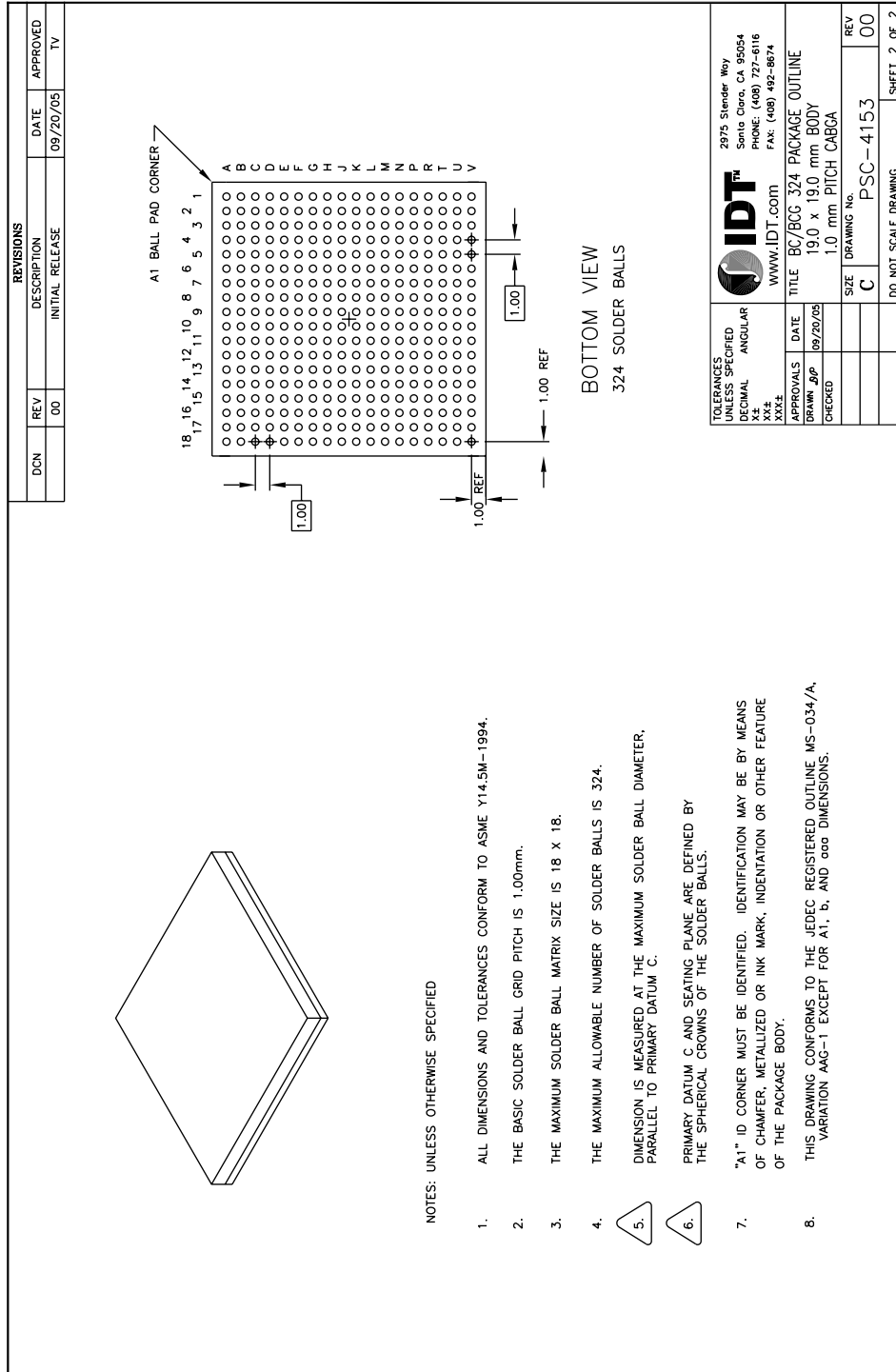

## Revision History

**July 18, 2006:** Publication of YC data sheet.

**April 4, 2007:** In Table 2, revised description for MSMBCLK signal to include “active only when EEPROM data is being loaded.”

**November 14, 2007:** Added new parameter, Termination Resistor, to Table 8, Input Clock Requirements.

**April 9, 2010:** Revised package drawing on pages 25 and 26.

## Ordering Information

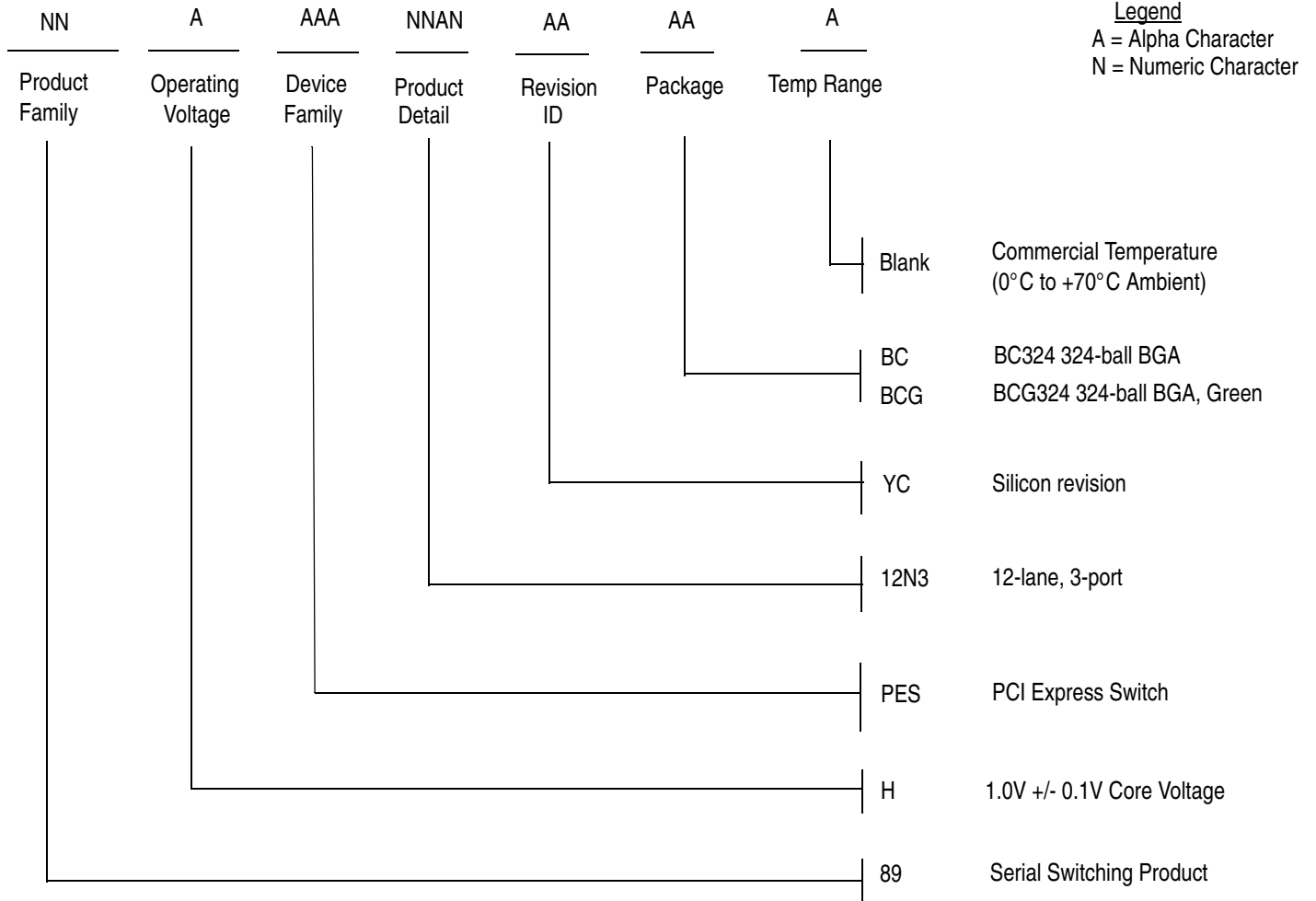

**Legend**

A = Alpha Character  
N = Numeric Character

### Valid Combinations

- 89HPES12N3YCBC 324-pin BC324 package, Commercial Temperature
- 89HPES12N3YCBCG 324-pin Green BC324 package, Commercial Temperature



**CORPORATE HEADQUARTERS**  
6024 Silver Creek Valley Road  
San Jose, CA 95138

**for SALES:**  
800-345-7015 or 408-284-8200  
fax: 408-284-2775  
[www.idt.com](http://www.idt.com)

**for Tech Support:**  
email: [ssdhelp@idt.com](mailto:ssdhelp@idt.com)  
phone: 408-284-8208