

NRND – Not Recommend for New Designs

The MPC942 is a 1:18 low voltage clock distribution chip with 2.5V or 3.3V LVCMOS output capabilities. The device is offered in two versions; the MPC942C has an LVCMOS input clock while the MPC942P has a LVPECL input clock. The 18 outputs are 2.5V or 3.3V LVCMOS compatible and feature the drive strength to drive 50Ω series or parallel terminated transmission lines. With output-to-output skews of 200ps, the MPC942 is ideal as a clock distribution chip for the most demanding of synchronous systems. The 2.5V outputs also make the device ideal for supplying clocks for a high performance Pentium II™ microprocessor based design.

- LVCMOS/LVTTL Clock Input
- 2.5V LVCMOS Outputs for Pentium II Microprocessor Support
- 150ps Maximum Targeted Output-to-Output Skew
- Maximum Output Frequency of 250MHz @ 3.3 V_{CC}
- 32-Lead TQFP Packaging
- Single 3.3V or 2.5V Supply
- **NRND – Not Recommend for New Designs**

With a low output impedance ($\approx 12\Omega$), in both the HIGH and LOW logic states, the output buffers of the MPC942 are ideal for driving series terminated transmission lines. With an output impedance of 12Ω the MPC942 can drive two series terminated transmission lines from each output. This capability gives the MPC942 an effective fanout of 1:36. The MPC942 provides enough copies of low skew clocks for most high performance synchronous systems.

The LVCMOS/LVTTL input of the MPC942C provides a more standard LVCMOS interface. The OE pins will place the outputs into a high impedance state. The OE pin has an internal pullup resistor.

The MPC942 is a single supply device. The V_{CC} power pins require either 2.5V or 3.3V. The 32-lead TQFP package was chosen to optimize performance, board space and cost of the device. The 32-lead TQFP has a 7x7mm body size with a conservative 0.8mm pin spacing.

MPC942C

**LOW VOLTAGE
1:18 CLOCK
DISTRIBUTION CHIP**



**AC SUFFIX
32-LEAD TQFP PACKAGE
Pb-FREE PACKAGE
CASE 873A-03**

Pentium II is a trademark of Intel Corporation.

LOGIC DIAGRAM

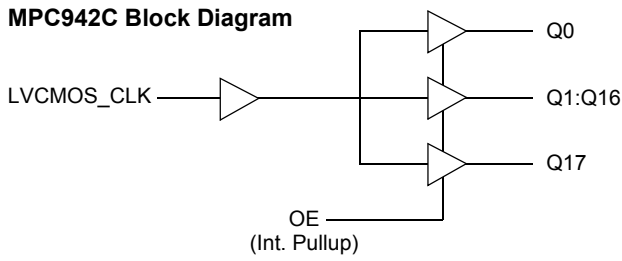

FUNCTION TABLE

OE	Output
0	HIGH IMPEDANCE
1	OUTPUTS ENABLED

Pinout: 32-Lead (Top View)

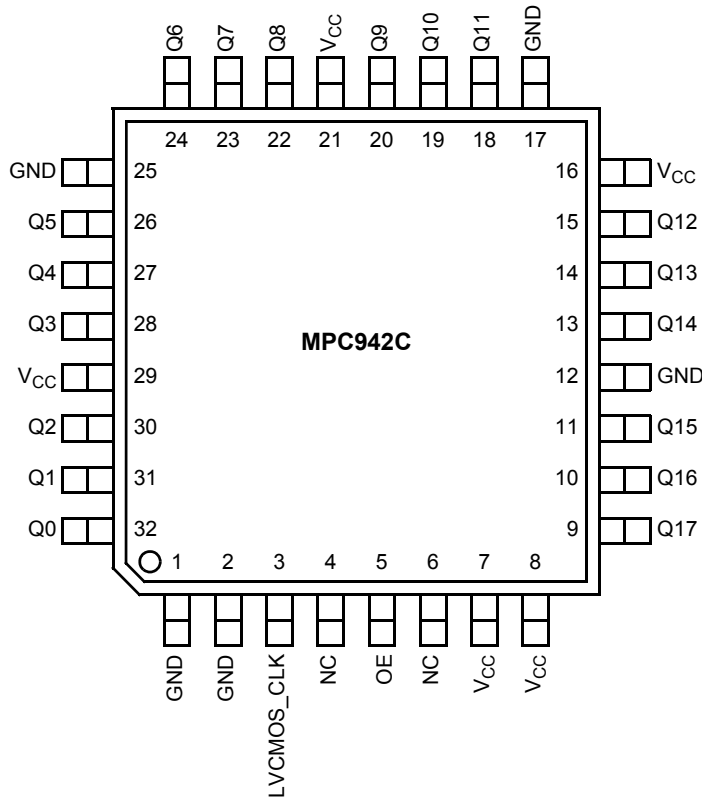

Table 1. Absolute Maximum Ratings

Symbol	Parameter	Min	Max	Unit
V _{CC}	Supply Voltage	-0.3	3.6	V
V _I	Input Voltage	-0.3	V _{CC} + 0.3	V
I _{IN}	Input Current		±20	mA
T _{Stor}	Storage Temperature Range	-40	125	°C

Table 2. DC Characteristics ($T_A = 0^\circ$ to 70°C , $V_{CCI} = 2.5\text{V} \pm 5\%$, $V_{CCO} = 2.5\text{V} \pm 5\%$)

Symbol	Characteristic	Min	Typ	Max	Unit	Condition
V_{IH}	Input HIGH Voltage	2.0		V_{CCI}	V	
V_{IL}	Input LOW Voltage			0.8	V	
V_{OH}	Output HIGH Voltage	2.0			V	$I_{OH} = -16\text{ mA}$
V_{OL}	Output LOW Voltage			0.5	V	$I_{OL} = 16\text{ mA}$
I_{IN}	Input Current			± 200	μA	
C_{IN}	Input Capacitance		4.0		pF	
C_{PD}	Power Dissipation Capacitance		14		pF	Per Output
Z_{OUT}	Output Impedance		12		Ω	
I_{CC}	Maximum Quiescent Supply Current		0.5		mA	

Table 3. AC Characteristics ($T_A = 0^\circ$ to 70°C , $V_{CCI} = 2.5\text{V} \pm 5\%$, $V_{CCO} = 2.5\text{V} \pm 5\%$)

Symbol	Characteristic	Min	Typ	Max	Unit	Condition
F_{max}	Maximum Frequency			200	MHz	
t_{PLH}	Propagation Delay	1.5		2.8	ns	
$t_{sk(o)}$	Output-to-Output Skew			200	ps	
$t_{sk(pr)}$	Part-to-Part Skew			1.3	ns	Notes 1, 2
$t_{sk(pr)}$	Part-to-Part Skew			600	ps	Notes 1, 3
d_t	Duty Cycle	45		55	%	
t_r, t_f	Output Rise/Fall Time	0.2		1.0	ns	

Table 4. DC Characteristics ($T_A = 0^\circ$ to 70°C , $V_{CCI} = 3.3\text{V} \pm 5\%$, $V_{CCO} = 3.3\text{V} \pm 5\%$)

Symbol	Characteristic	Min	Typ	Max	Unit	Condition
V_{IH}	Input HIGH Voltage	2.4		V_{CCI}	V	
V_{IL}	Input LOW Voltage			0.8	V	
V_{OH}	Output HIGH Voltage	2.4			V	$I_{OH} = -20\text{ mA}$
V_{OL}	Output LOW Voltage			0.5	V	$I_{OL} = 20\text{ mA}$
I_{IN}	Input Current			± 200	μA	
C_{IN}	Input Capacitance		4.0		pF	
C_{PD}	Power Dissipation Capacitance		14		pF	Per Output
Z_{OUT}	Output Impedance		12		Ω	
I_{CC}	Maximum Quiescent Supply Current		0.5		mA	

Table 5. AC Characteristics ($T_A = 0^\circ$ to 70°C , $V_{CCI} = 3.3\text{V} \pm 5\%$, $V_{CCO} = 3.3\text{V} \pm 5\%$)

Symbol	Characteristic	Min	Typ	Max	Unit	Condition
F_{max}	Maximum Frequency			250	MHz	
t_{PLH}	Propagation Delay	1.3		2.3	ns	Note 1
$t_{sk(o)}$	Output-to-Output Skew			200	ps	
$t_{sk(pr)}$	Part-to-Part Skew			1.0	ns	Notes 1, 2
$t_{sk(pr)}$	Part-to-Part Skew			500	ps	Notes 1, 3
d_t	Duty Cycle	45		55	%	
t_r, t_f	Output Rise/Fall Time	0.2		1.0	ns	

1. Tested using standard input levels, production tested @ 133 MHz.
2. Across temperature and voltage ranges, includes output skew.
3. For a specific temperature and voltage, includes output skew.

PACKAGE DIMENSIONS

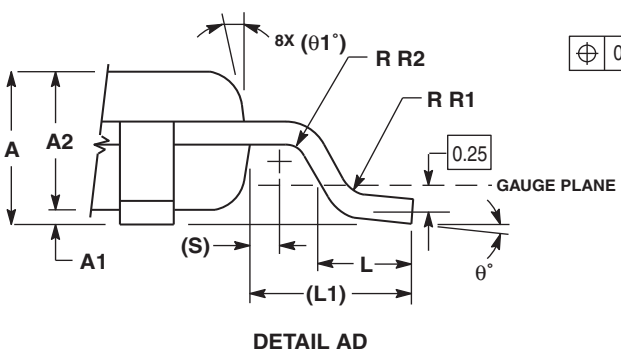
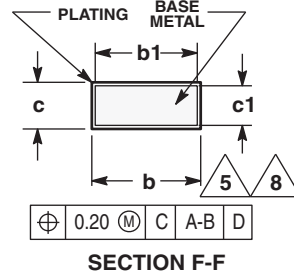
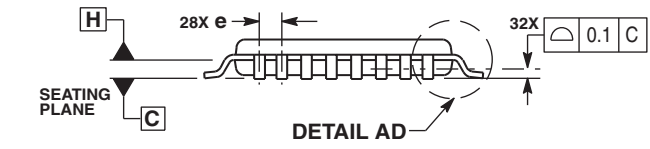
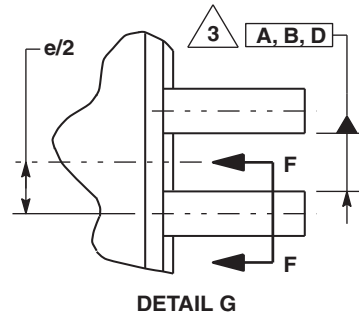
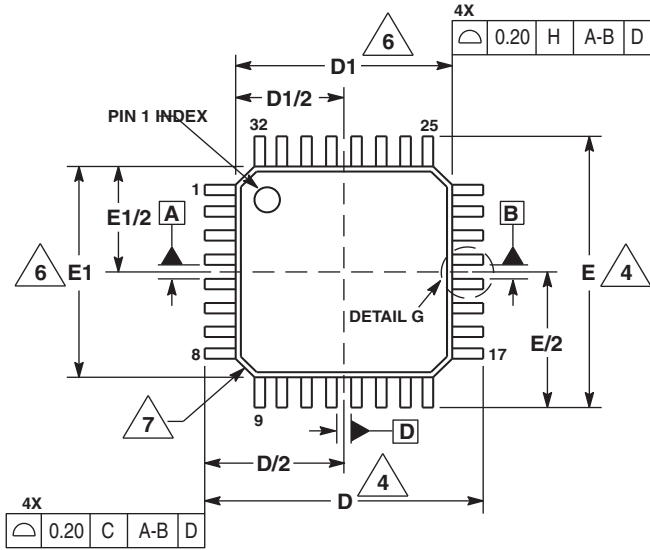

- NOTES:
1. DIMENSIONS ARE IN MILLIMETERS.
 2. INTERPRET DIMENSIONS AND TOLERANCES PER ASME Y14.5M, 1994.
 3. DATUMS A, B, AND D TO BE DETERMINED AT DATUM PLANE H.
 4. DIMENSIONS D AND E TO BE DETERMINED AT SEATING PLANE C.
 5. DIMENSION b DOES NOT INCLUDE DAMBAR PROTRUSION. ALLOWABLE DAMBAR PROTRUSION SHALL NOT CAUSE THE LEAD WIDTH TO EXCEED THE MAXIMUM b DIMENSION BY MORE THAN 0.08-mm. DAMBAR CANNOT BE LOCATED ON THE LOWER RADIUS OR THE FOOT. MINIMUM SPACE BETWEEN PROTRUSION AND ADJACENT LEAD OR PROTRUSION: 0.07-mm.
 6. DIMENSIONS D1 AND E1 DO NOT INCLUDE MOLD PROTRUSION. ALLOWABLE PROTRUSION IS 0.25-mm PER SIDE. D1 AND E1 ARE MAXIMUM PLASTIC BODY SIZE DIMENSIONS INCLUDING MOLD MISMATCH.
 7. EXACT SHAPE OF EACH CORNER IS OPTIONAL.
 8. THESE DIMENSIONS APPLY TO THE FLAT SECTION OF THE LEAD BETWEEN 0.1-mm AND 0.25-mm FROM THE LEAD TIP.

MILLIMETERS		
DIM	MIN	MAX
A	1.40	1.60
A1	0.05	0.15
A2	1.35	1.45
b	0.30	0.45
b1	0.30	0.40
c	0.09	0.20
c1	0.09	0.16
D	9.00 BSC	
D1	7.00 BSC	
e	0.80 BSC	
E	9.00 BSC	
E1	7.00 BSC	
L	0.50	0.70
L1	1.00 REF	
q	0°	7°
q1	12 REF	
R1	0.08	0.20
R2	0.08	---
S	0.20 REF	

CASE 873A-03
 ISSUE B
 LQFP PLASTIC PACKAGE

Revision History Sheet

Rev	Table	Page	Description of Change	Date
2		1	NRND – Not Recommend for New Designs	1/8/13

We've Got Your Timing Solution



6024 Silver Creek Valley Road
San Jose, California 95138

Sales
800-345-7015 (inside USA)
+408-284-8200 (outside USA)
Fax: 408-284-2775
www.IDT.com/go/contactIDT

Technical Support
netcom@idt.com
+480-763-2056

DISCLAIMER Integrated Device Technology, Inc. (IDT) and its subsidiaries reserve the right to modify the products and/or specifications described herein at any time and at IDT's sole discretion. All information in this document, including descriptions of product features and performance, is subject to change without notice. Performance specifications and the operating parameters of the described products are determined in the independent state and are not guaranteed to perform the same way when installed in customer products. The information contained herein is provided without representation or warranty of any kind, whether express or implied, including, but not limited to, the suitability of IDT's products for any particular purpose, an implied warranty of merchantability, or non-infringement of the intellectual property rights of others. This document is presented only as a guide and does not convey any license under intellectual property rights of IDT or any third parties.

IDT's products are not intended for use in applications involving extreme environmental conditions or in life support systems or similar devices where the failure or malfunction of an IDT product can be reasonably expected to significantly affect the health or safety of users. Anyone using an IDT product in such a manner does so at their own risk, absent an express, written agreement by IDT.

Integrated Device Technology, IDT and the IDT logo are registered trademarks of IDT. Other trademarks and service marks used herein, including protected names, logos and designs, are the property of IDT or their respective third party owners.

Copyright 2012. All rights reserved.