

DATE	REV	ECN	APP'D. BY
2/1/06	AO	7460	JM

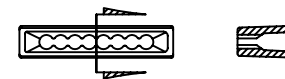

MANAGEMENT BAR TO BE USED WITH PLUG

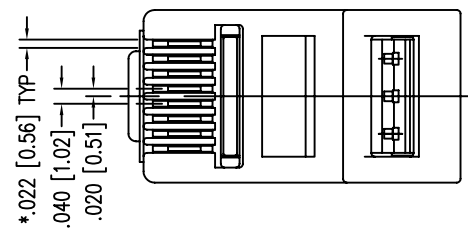
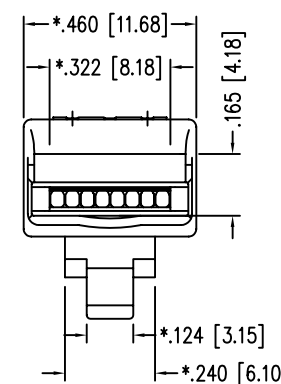
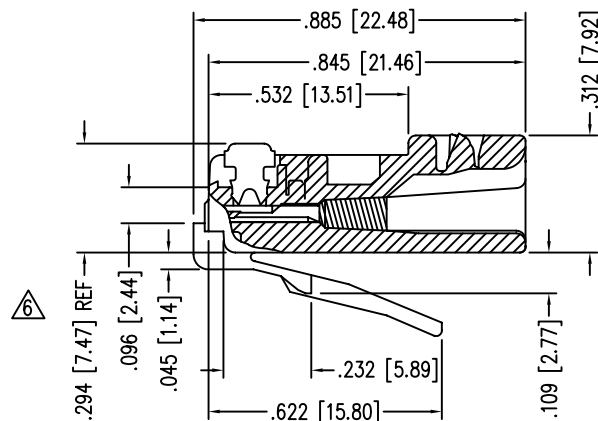
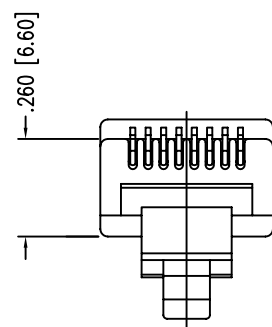

NOTES:

- 1- PLUG KIT CONSISTS OF :  
PRE-INSERTED PLUG HOUSING  
MANAGEMENT BAR
- 2- MATERIALS :  
FRONT HOUSING PLASTIC : CLEAR POLYCARBONATE, UL 94-V0  
MANAGEMENT BAR : CLEAR POLYCARBONATE, UL 94-V0  
CONTACTS : PHOSPHOR BRONZE, SELECTIVE GOLD PLATING
- 3- CONTACTS TERMINATE STRANDED & SOLID CONDUCTORS UP TO .037 [0.94] OUTSIDE DIAMETER OF INSULATION.
- 4- FOR PRODUCT SPECIFICATION SEE PRO26-01.
- 5- TOLERANCES COMPLY WITH F.C.C. DIMENSION REQUIREMENTS.
- ⚠ TERMINATED PLUG HEIGHT: .237 [6.02] ±.005 [0.13]

BULK	50 MICRO-INCHES [1.27um]	940-SP-3088-2PC-F-A192
BULK	50 MICRO-INCHES [1.27um]	940-SP-3088-2PC-A192
PACKAGE	CONTACT PLATING IN MATING AREA	PART NUMBER

THIRD ANGLE PROJECTION

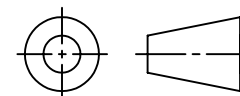

DO NOT SCALE DRAWING  
DRAWING IS SUBJECT TO  
CHANGE WITHOUT NOTICE

DIMENSIONS: INCHES [METRIC]

UNLESS OTHERWISE SPECIFIED  
TOLERANCES ARE ±.005 [0.13]  
ANGLES ARE ± 1°

SHEET NO. 1 OF 1

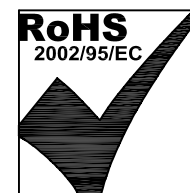

# Bel Stewart Connector

11118 Susquehanna Trail South  
Glen Rock, PA 17327-9199  
(717) 235-7512 Fax: (717) 235-7954 <http://www.stewartconnector.com>

TITLE: EIGHT CONDUCTOR/EIGHT POSITION LINE CORD MODULE;

THIS DRAWING AND THE SUBJECT MATTER SHOWN THEREON ARE CONFIDENTIAL AND THE PROPRIETARY PROPERTY OF BEL STEWART CONNECTOR AND SHALL NOT BE REPRODUCED, COPIED, OR USED IN ANY MANNER WITHOUT PRIOR WRITTEN CONSENT OF BEL STEWART CONNECTOR. THE SUBJECT MATTER MAY BE PATENTED OR A PATENT MAY BE PENDING.

DRN BY: KRL	DATE 1/31/06
APPD BY: JM	DATE 2-1-06
DWG NO. CT300111	REV. AO