

### Description

The GM66300, GM66301 and GM66302 are 3.0A, low dropout linear voltage regulators that provide a low voltage, high-current output with a minimum of external components. Utilizing proprietary Super beta PNP pass element, the GM66300/1/2 offers extremely low dropout (typically 400mV at 3.0A) and low ground current (typically 36mA at 3.0A).

The GM66300/1/2 is ideal for PC add-in cards that need to convert from standard 3.3V to 2.5V or 2.5V to 1.8V. A guaranteed maximum dropout voltage of 500mV over all operating conditions allows the GM66300/1/2 to provide 2.5V from a supply as low as 3V, and 1.8V from a supply as low as 2.5V. The GM66300/1/2 also has fast transient response for heavy switching applications. The device requires only 47µF of output capacitance to maintain stability and achieve fast transient response.

The GM66300/1/2 is fully protected with over current limiting, thermal shutdown, reversed-battery protection, reversed-leakage protection, and reversed-lead insertion. The GM66301 offers a TTL-logic compatible enable pin and an error flag that indicates under voltage and over current conditions. Offered in fixed voltages, the GM66300/1 comes in the TO-220 and TO-263 packages and is an ideal upgrade to older, NPN-based linear voltage regulators.

The GM66302 is adjustable version, with On/Off feature.

### Features

- ◆ 3.0A minimum guaranteed output current
- ◆ 500mV maximum dropout voltage over temperature, which is ideal for 3.0V to 2.5V conversion and 2.5V to 1.8V conversion.
- ◆ 1% initial accuracy
- ◆ Low ground current
- ◆ Current limiting and Thermal shutdown
- ◆ Reversed-battery protection
- ◆ Reversed-leakage protection
- ◆ Fast transient response
- ◆ Error flag output (GM66301 only)
- ◆ Adjustable version (GM66302 only)

### Application

- PC Add-in Cards
- High Efficiency Linear Power Supplies
- Multi-media and PC Processor Supplies
- Low Voltage Microcontrollers
- Automotive Electronics

### Typical Application Circuits

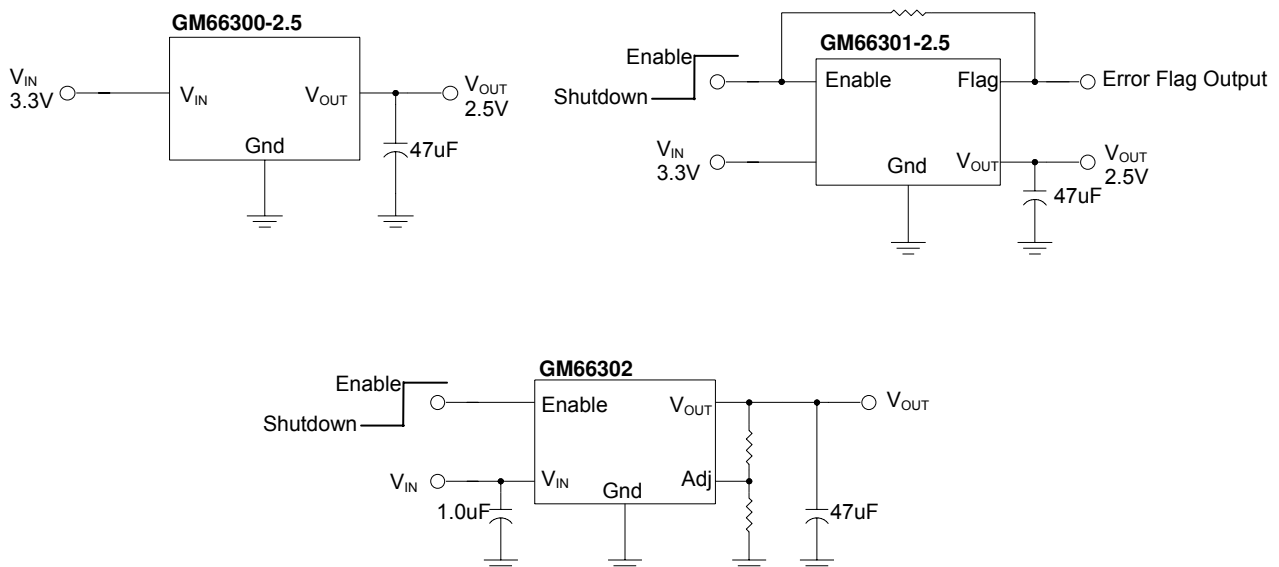

### Marking Information and Pin Configurations (Top View)

#### GM66300 (Pb Free)

TO 220

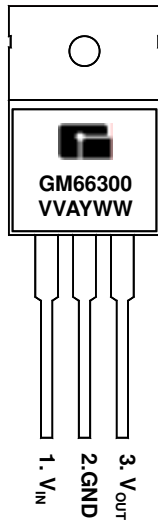

TO 263  
(D<sup>2</sup>-PAK)

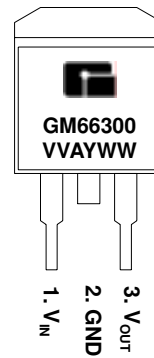

VV: Voltage suffix (15 = 1.5V, 50 = 5.0V...A = Adj)  
 A: Assembly / Test site code  
 Y: Year  
 WW: Week

#### GM66300 (Green Product)

TO 220

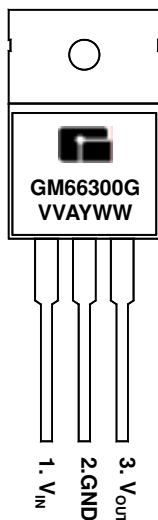

TO 263  
(D<sup>2</sup>-PAK)

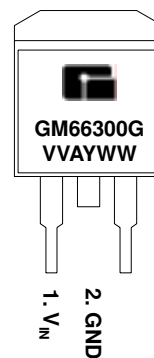

G: Green Product  
 VV: Voltage suffix (15 = 1.5V, 50 = 5.0V...A = Adj)  
 A: Assembly / Test site code  
 Y: Year  
 WW: Week

## Marking Information and Pin Configurations (Top View)

### GM66301 (Pb Free)

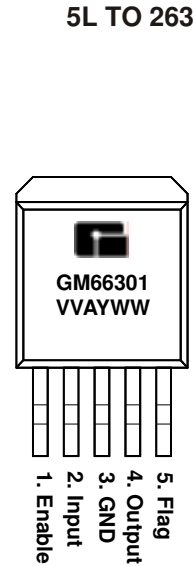
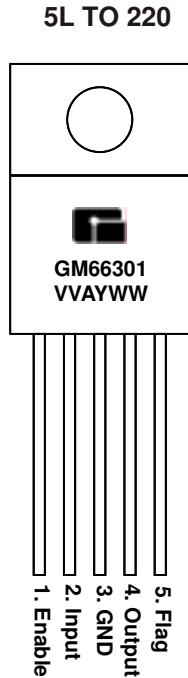

VV: Voltage suffix (15 = 1.5V, 50 = 5.0V...A = Adj)  
 A: Assembly / Test site code  
 Y: Year  
 WW: Week

### GM66301 (Green Product)

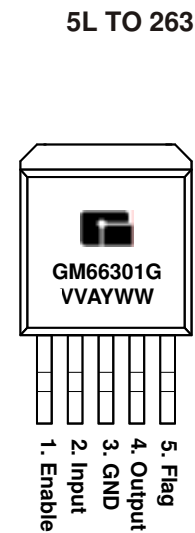
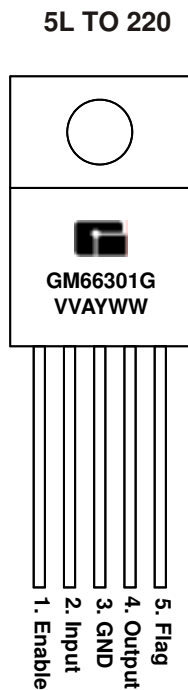

G: Green Product  
 VV: Voltage suffix (15 = 1.5V, 50 = 5.0V...A = Adj)  
 A: Assembly / Test site code  
 Y: Year  
 WW: Week

## Marking Information and Pin Configurations (Top View)

### GM66302 (Pb Free)

5L TO 220

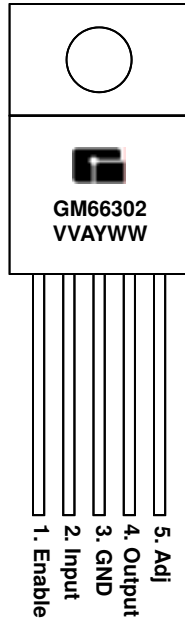

5L TO 263

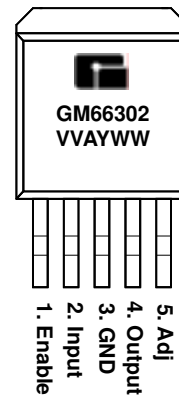

VV: Voltage suffix (15 = 1.5V, 50 = 5.0V...A = Adj)  
 A: Assembly / Test site code  
 Y: Year  
 WW: Week

### GM66302 (Green Product)

5L TO 220

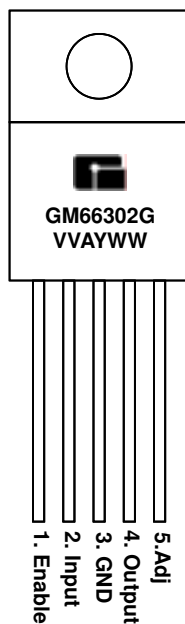

5L TO 263

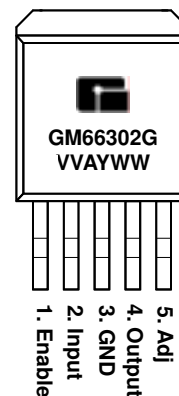

G: Green Product  
 VV: Voltage suffix (15 = 1.5V, 50 = 5.0V...A = Adj)  
 A: Assembly / Test site code  
 Y: Year  
 WW: Week

## Ordering Information – Pb Free

Ordering Number	Output Voltage	Package	Shipping
<b>GM66300</b>			
GM66300-1.8TA3T	1.8V	TO-263	50 Units/Tube
GM66300-1.8TA3R	1.8V	TO-263	800 Units / Reel
GM66300-1.8TB3T	1.8V	TO-220	50 Units/Tube
GM66300-2.5TA3T	2.5V	TO-263	50 Units/Tube
GM66300-2.5TA3R	2.5V	TO-263	800 Units / Reel
GM66300-2.5TB3T	2.5V	TO-220	50 Units/Tube
GM66300-3.3TA3T	3.3V	TO-263	50 Units/Tube
GM66300-3.3TA3R	3.3V	TO-263	800 Units / Reel
GM66300-3.3TB3T	3.3V	TO-220	50 Units/Tube
GM66300-5.0TA3T	5.0V	TO-263	50 Units/Tube
GM66300-5.0TA3R	5.0V	TO-263	800 Units / Reel
GM66300-5.0TB3T	5.0V	TO-220	50 Units/Tube

## Ordering Information – Green Product

Ordering Number	Output Voltage	Package	Shipping
<b>GM66300</b>			
GM66300-1.8TA3TG	1.8V	TO-263	50 Units/Tube
GM66300-1.8TA3RG	1.8V	TO-263	800 Units / Reel
GM66300-1.8TB3TG	1.8V	TO-220	50 Units/Tube
GM66300-2.5TA3TG	2.5V	TO-263	50 Units/Tube
GM66300-2.5TA3RG	2.5V	TO-263	800 Units / Reel
GM66300-2.5TB3TG	2.5V	TO-220	50 Units/Tube
GM66300-3.3TA3TG	3.3V	TO-263	50 Units/Tube
GM66300-3.3TA3RG	3.3V	TO-263	800 Units / Reel
GM66300-3.3TB3TG	3.3V	TO-220	50 Units/Tube
GM66300-5.0TA3TG	5.0V	TO-263	50 Units/Tube
GM66300-5.0TA3RG	5.0V	TO-263	800 Units / Reel
GM66300-5.0TB3TG	5.0V	TO-220	50 Units/Tube

### Ordering Information – Pb Free

Ordering Number	Output Voltage	Package	Shipping
<b>GM66301</b>			
GM66301-1.8TA5T	1.8V	5L-TO-263	50 Units/Tube
GM66301-1.8TA5R	1.8V	5L-TO-263	800 Units / Reel
GM66301-1.8TB5T	1.8V	5L-TO-220	50 Units/Tube
GM66301-2.5TA5T	2.5V	5L-TO-263	50 Units/Tube
GM66301-2.5TA5R	2.5V	5L-TO-263	800 Units / Reel
GM66301-2.5TB5T	2.5V	5L-TO-220	50 Units/Tube
GM66301-3.3TA5T	3.3V	5L-TO-263	50 Units/Tube
GM66301-3.3TA5R	3.3V	5L-TO-263	800 Units / Reel
GM66301-3.3TB5T	3.3V	5L-TO-220	50 Units/Tube
GM66301-5.0TA5T	5.0V	5L-TO-263	50 Units/Tube
GM66301-5.0TA5R	5.0V	5L-TO-263	800 Units / Reel
GM66301-5.0TB5T	5.0V	5L-TO-220	50 Units/Tube

### Ordering Information – Green Product

Ordering Number	Output Voltage	Package	Shipping
<b>GM66301</b>			
GM66301-1.8TA5TG	1.8V	TO-263-5	50 Units/Tube
GM66301-1.8TA5RG	1.8V	TO-263-5	800 Units / Reel
GM66301-1.8TB5TG	1.8V	TO-220-5	50 Units/Tube
GM66301-2.5TA5TG	2.5V	TO-263-5	50 Units/Tube
GM66301-2.5TA5RG	2.5V	TO-263-5	800 Units / Reel
GM66301-2.5TB5TG	2.5V	TO-220-5	50 Units/Tube
GM66301-3.3TA5TG	3.3V	TO-263-5	50 Units/Tube
GM66301-3.3TA5RG	3.3V	TO-263-5	800 Units / Reel
GM66301-3.3TB5TG	3.3V	TO-220-5	50 Units/Tube
GM66301-5.0TA5TG	5.0V	TO-263-5	50 Units/Tube
GM66301-5.0TA5RG	5.0V	TO-263-5	800 Units / Reel
GM66301-5.0TB5TG	5.0V	TO-220-5	50 Units/Tube



# GM66300 Series

3.0A ULTRA LOW DROPOUT VOLTAGE REGULATORS

## Ordering Information – Pb Free

Ordering Number	Output Voltage	Package	Shipping
<b>GM66302</b>			
GM66302TA5T	Adj	TO-263-5	50 Units/Tube
GM66302TA5R	Adj	TO-263-5	800 Units / Reel
GM66302TB5T	Adj	TO-220-5	50 Units/Tube

## Ordering Information – Green Product

Ordering Number	Output Voltage	Package	Shipping
<b>GM66302</b>			
GM66302TA5TG	Adj	TO-263-5	50 Units/Tube
GM66302TA5RG	Adj	TO-263-5	800 Units / Reel
GM66302TB5TG	Adj	TO-220-5	50 Units/Tube