

Advanced Monolithic Systems

AMS6104

1A SWITCH BOOST CONVERTER

RoHS compliant

FEATURES

- Internal Power Switch
- Output Voltage up to 20V
- Up to 89% Efficiency
- Low 0.08 μ A Shutdown Supply Current
- Internal Current Limit
- Thermal Shutdown
- Available in 5-Pin SOT-23 Package

APPLICATIONS

- Handheld Computers, PDA's
- Cell Phones
- Digital Still and Video Games
- Small LCD Displays

GENERAL DESCRIPTION

The AMS6104 is an adjustable step-up DC/DC converter with a 1Amp internal switch. The low quiescent current of typical 300 μ A, makes AMS6104 attractive for battery operated applications. AMS6104 operates at switching frequencies of 500 kHz allowing for easy filtering and low noise. The reference voltage is set at 1.23V. Internally compensated and internal soft-start minimizes the number of external components necessary. It operates from 1.3V to 15V supply and it is thermally and over current protected. The AMS6104 is available in SOT23-5 leads package.

ORDERING INFORMATION

OUTPUT	PACKAGE TYPE	TEMP.
VOLTAGE	5 Lead SOT-23	RANGE
Adjustable	AMS6104M1	-25°C to 125°C

PIN CONNECTIONS

5L SOT-23
(M1)

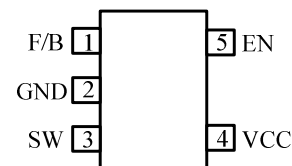

Top View

TYPICAL APPLICATION

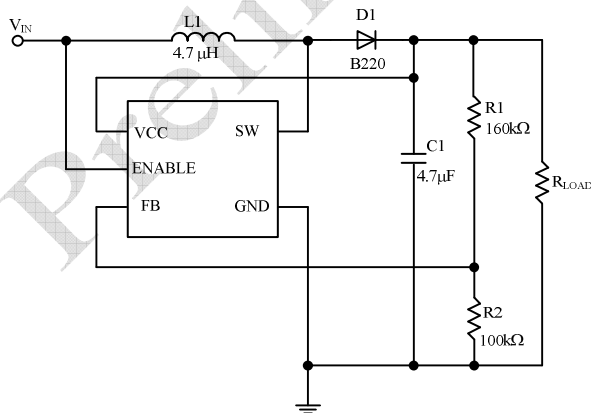

PIN DESCRIPTION

PIN NUMBERS	NAME	DESCRIPTION
1	FB	Feedback Input. Connect a resistive voltage divider from the output voltage to FB to set the output voltage. The feedback regulation threshold is 1.23V.
2	GND	Ground
3	SW	High side of the Switch transistor. The Low side of the Switch transistor is internally connected to GND
4	VCC	Internal Power Input. VCC powers the internal circuitry. If the input source remains above 3.0V, VCC can be connected to the input source to reduce power consumption.
5	EN	Enable. A high voltage at EN turns on the converter, and a low voltage turns it off. When not used, connect EN to the input source for automatic startup. If EN is driven over 6V, place a 10 kΩ to 47kΩ resistor in series with EN.

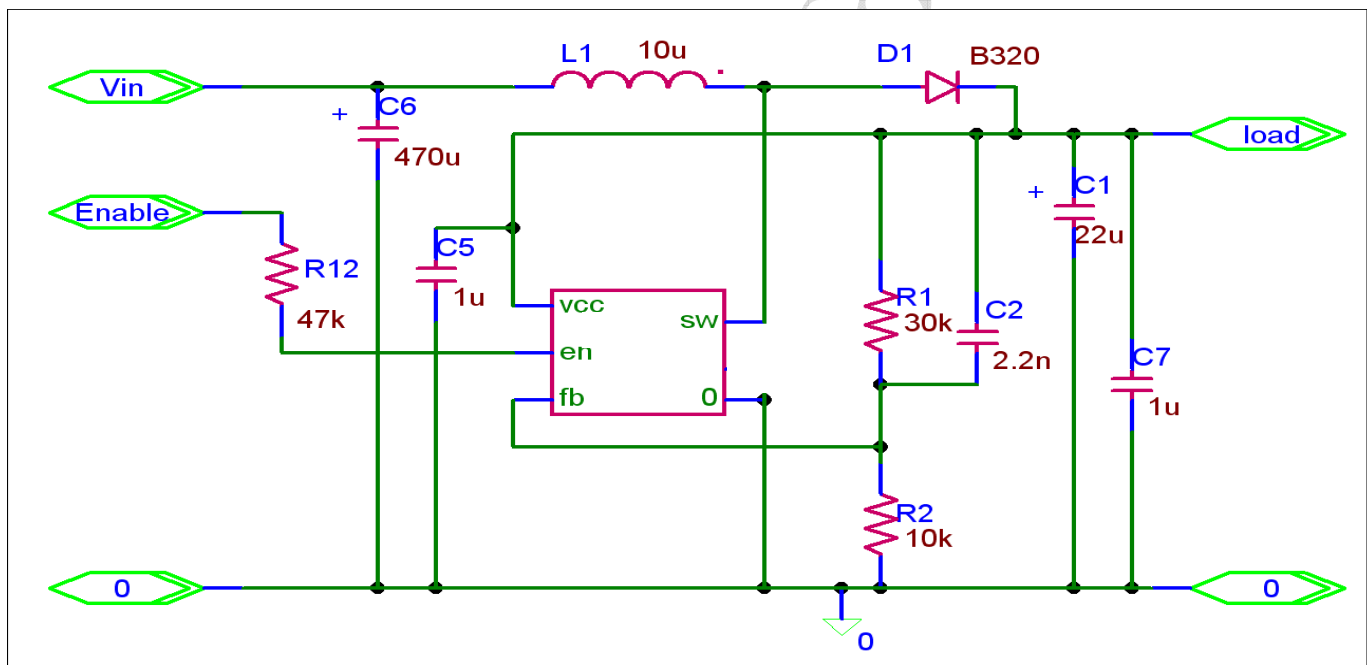

3.3V to 5.0V application

ABSOLUTE MAXIMUM RATINGS

VCC	-0.3V to 15V	Operating Temperature	-20°C to +105°C
SW	-0.5V to 20V	Junction Temperature	150°C
All other pins	-0.3V to 6V	Solder Temperature	230°C
VCC Supply Voltage	1.3V to 15V	Storage Temperature	-65°C to 150°C
Output Voltage	V _{IN} to 20V	Thermal Resistance	410°C/W

ELECTRICAL CHARACTERISTICS

Electrical Characteristics at T_A = 25 °C, V_{CC} = V_{EN} = 3.3V (unless otherwise noted)

PARAMETER	TEST CONDITIONS	AMS6104			Units
		Min.	Typ.	Max.	
START-UP					
Operating Input Voltage		1.5		15	V
Minimum Start-up Voltage	I _{OUT} = 25mA		1.3	1.5	V
ENABLE					
EN Threshold	V _{EN} Rising	1.1	1.2	2.0	V
EN Hysteresis			40		mV
EN Input Bias Current	V _{EN} = 1.5V		5	8	μA
EN Input Bias Current	V _{EN} = 3.3V		15	20	μA
FEEDBACK COMPARATOR					
FB voltage		1.19	1.23	1.27	V
FB Input Bias Current	V _{FB} = 1.23V	-15	-10		nA
OUTPUT SWITCH					
SW On-Saturation voltage	V _{CC} = 5.0V		330	500	mV
SW Current Limit		0.9	1	1.5	A
SW Leakage Current	V _{SW} = 20V			10	μA
Output Switch Rise Time	(inductor controlled)		20		ns
Output Switch Fall Time			8		ns
Switching Frequency		424	475	525	Khz
Maximum duty cycle				95	%
DEVICE					
Efficiency	V _{OUT} = 5.0V; I _{OUT} = 1mA to 500mA		85		%
Supply Current (Shutdown)	V _{EN} = 0V, no F/B resistors		80	150	nA
Supply Current (Quiescent)	V _{FB} = 1.3V; I _{OUT} = 0mA		480	600	μA
Load Regulation	V _{OUT} = 5.0V; I _{OUT} = 1mA to 500mA		16	25	mV
Line Regulation	I _{OUT} = 10mA ; V _{CC} = 3.3V to 12V		10	20	mV
Thermal Shutdown	I _{SW} = 1A		130		°C

TYPICAL PERFORMANCE CHARACTERISTICS

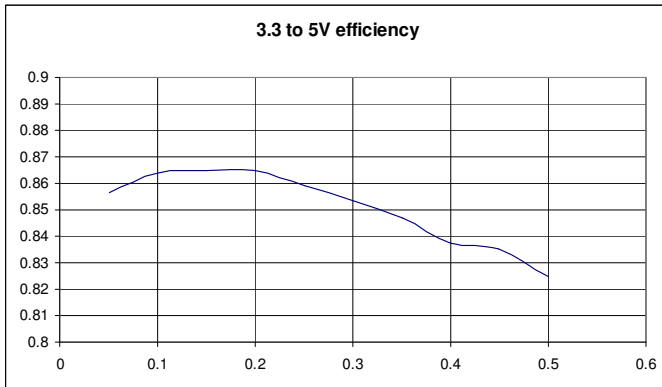

Efficiency VS Load for 5V output application achieving 0.5A

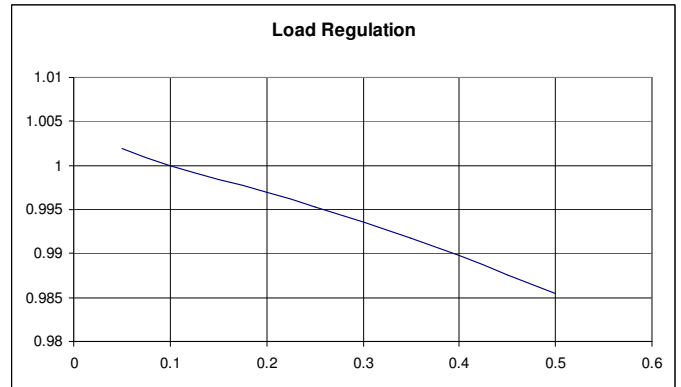

3.3V Input, 5V Output; normalized Load Regulation

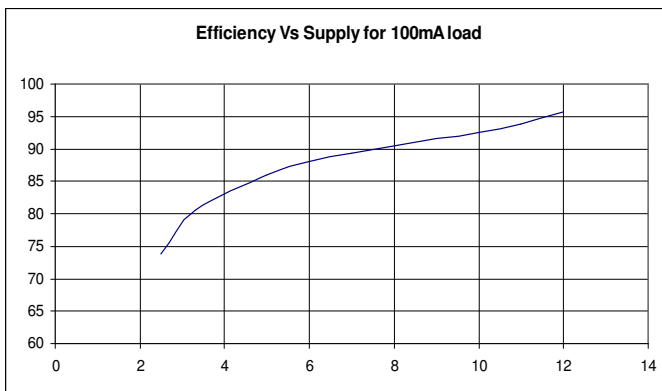

Efficiency VS Supply for 12V Output at 100mA load

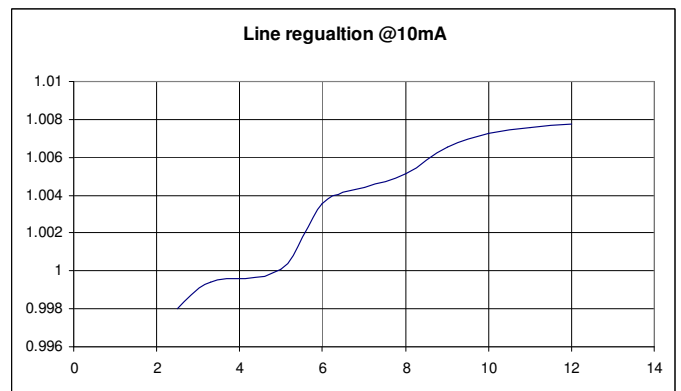

Light Load Line regulation (reverse load regulation) for 12V Output

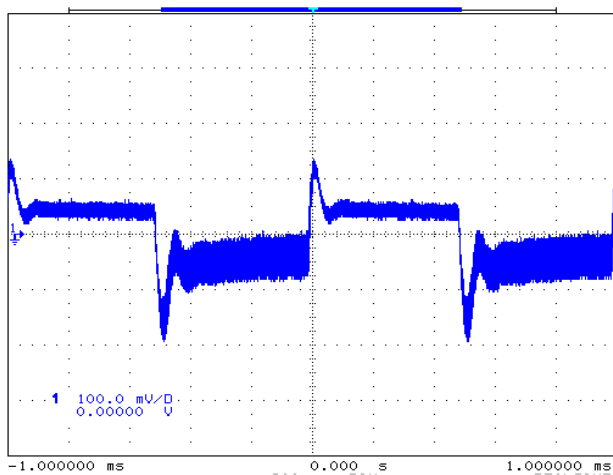

Load Transient 25-75% load 12V Output

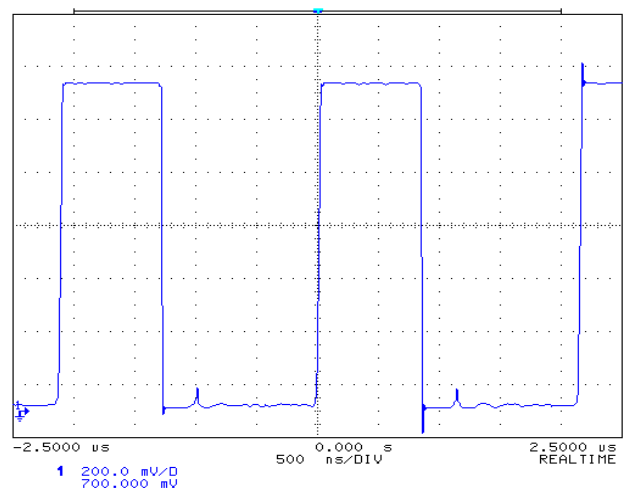

Normal Switching Waveform

TYPICAL PERFORMANCE CHARACTERISTICS (continued)

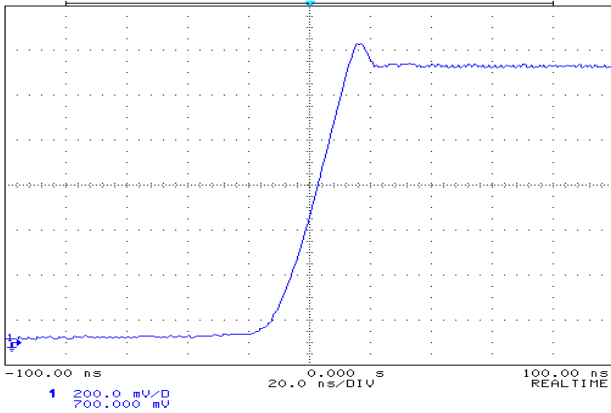

Waveform close-up showing Rise time

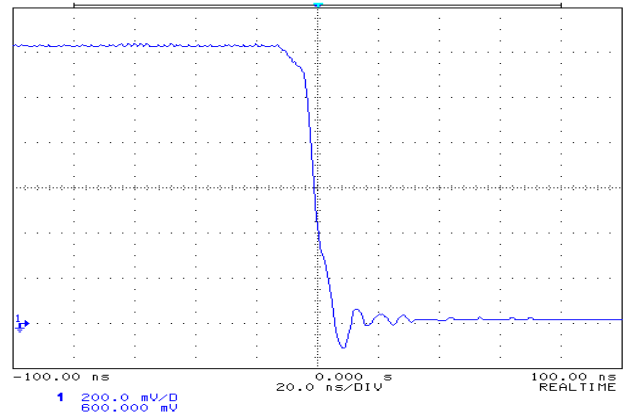

Waveform close-up showing Fall time

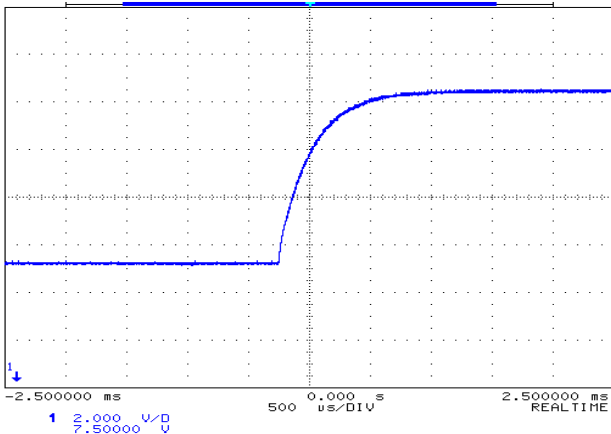

Full load (200mA) start-up -
22µF Tantalum Capacitor

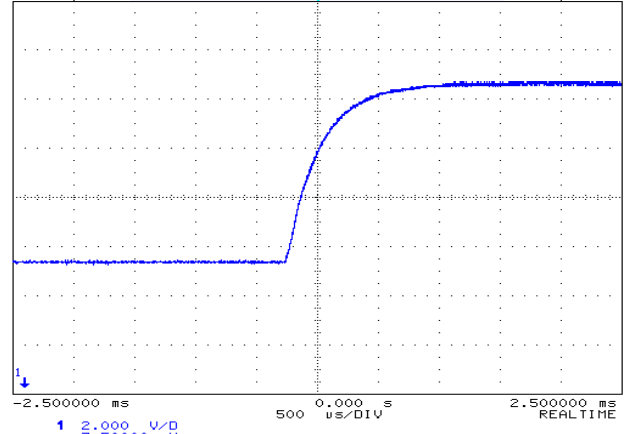

Minimal load (1mA) start-up -
22µF Tantalum Capacitor

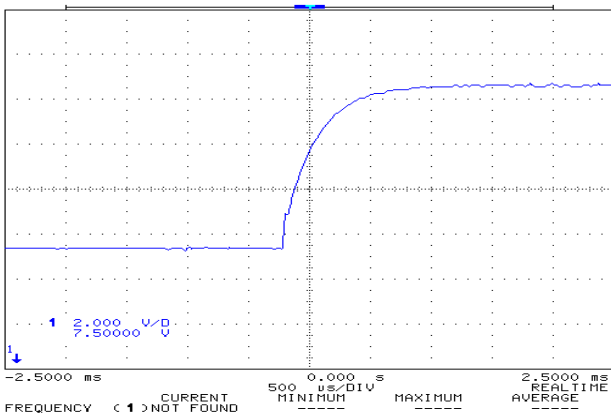

1mA load start-up -
3 X 1µF Ceramic output capacitor

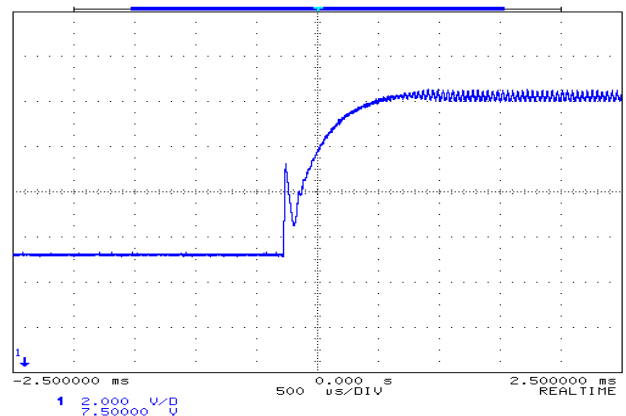

Full load (200mA) start-up
3 X 1µF Ceramic output capacitor

PACKAGE DIMENSIONS inches (millimeters) unless otherwise noted.

5 LEAD SOT-23 PLASTIC PACKAGE (M1)

