

FEATURES

- Low Temperature Coefficient
- Low Output Noise
- Operating Current 50 μ A to 4mA
- Low Dynamic Impedance
- Tight Output Voltage Tolerance
- Available in the sub-miniature SOT-23 Package

APPLICATIONS

- Battery Powered Systems
- Instrumentation
- Energy Management
- Product Testing
- Precision Audio Components
- Data Acquisition Systems

GENERAL DESCRIPTION

The AMS124 is a two-terminal micropower band-gap voltage reference diode featuring low dynamic impedance and good temperature coefficient, operating over a 50 μ A to 4mA current range. On-chip trimming is used to provide tight voltage tolerance. Since the AMS124 band-gap reference uses only transistors and resistors, low noise and good long term stability result. The wide dynamic operating range allows its use with widely varying supplies with excellent regulation. These voltage references can be used to make portable meters, regulators or general purpose analog circuitry.

The AMS124 is operational in the full industrial temperature range of -40°C to 85°C and is available in small space saving SOT-23 package.

ORDERING INFORMATION:

MAX. TEMPCO	PACKAGE TYPE	OPERATING TEMP. RANGE
	3 LEAD SOT-23	
50ppm/°C	AMS124AM	-40 to +85°C
100ppm/°C	AMS124BM	-40 to +85°C

PIN CONNECTIONS

3L SOT-23
(M)

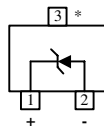

*This pin must be left floating
or connected to pin 2

Top View

ABSOLUTE MAXIMUM RATINGS (Note 1)

Reverse Current	5mA	Storage temperature	-65°C to +150°C
Forward Current	10mA	Internal Power Dissipation (P_D)	
Lead Temperature (25 sec)	265°C	SOT-23 Package	0.28W
		Thermal Resistance (θ_{JA})	
		SOT-23 Package	410°C/W

ELECTRICAL CHARACTERISTICS

Electrical Characteristics at $I_R = 500 \mu A$ and $T_A = +25^\circ C$ unless otherwise specified.

Parameter	Conditions	AMS124A			AMS124B			Units
		Min.	Typ.	Max.	Min.	Typ.	Max.	
Output Voltage		1.220	1.235	1.250	1.220	1.235	1.250	V
Output Impedance			0.6	2		0.6	2	Ω
RMS Noise Voltage	$10Hz \leq f \leq 10kHz$		5			5		μV_{rms}
Temperature Coefficient	$T_A = \text{Full Range}$			50			100	ppm/°C
Turn-On Settling	0.1% of V_{OUT}		15			15		μsec
Operating Current	(Note 3)	0.05		4	0.05		4	mA

Note 1: Absolute Maximum Ratings indicate limits beyond which damage to the device may occur. For guaranteed specifications and test conditions, see the Electrical Characteristics. The guaranteed specifications apply only for the test conditions listed.

Note 2: Parameters identified with **boldface type** apply at temperature extremes. All other numbers apply at $T_A = T_J = 25^\circ C$.

Note 3: Optimum performance is obtained at currents below 500 μA .

TYPICAL APPLICATIONS

Shunt Regulator

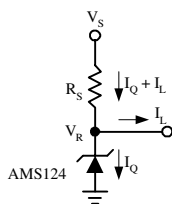

Precision 1 μA to 1mA Current Sources

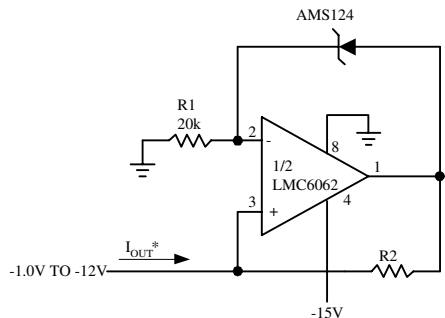

$$I_{OUT} = 1.2V/R2$$

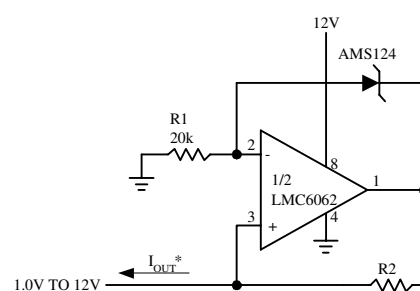

TYPICAL PERFORMANCE CHARACTERISTICS

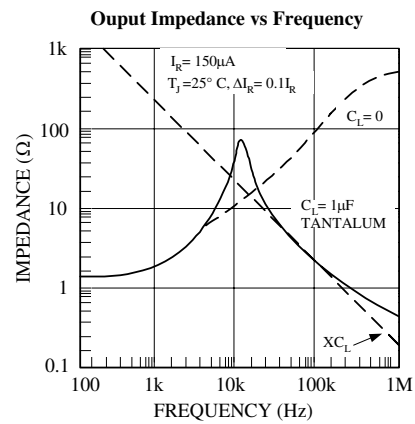
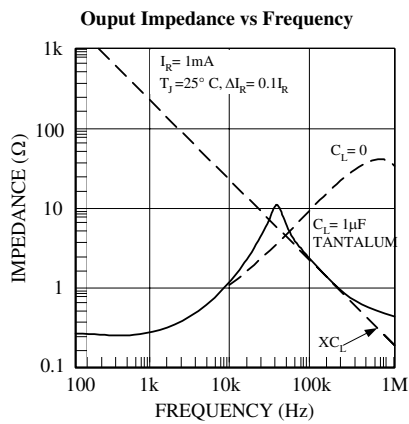
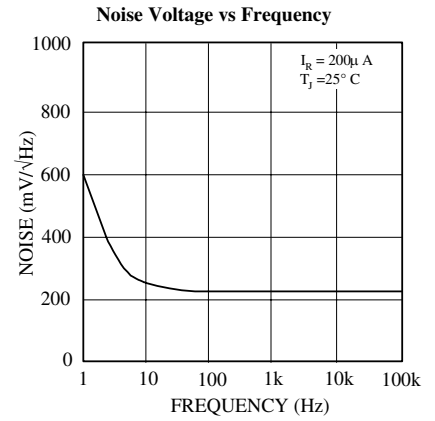
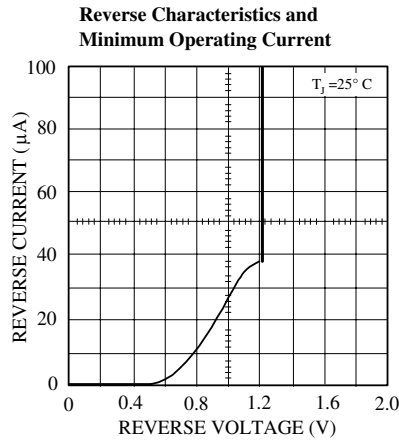
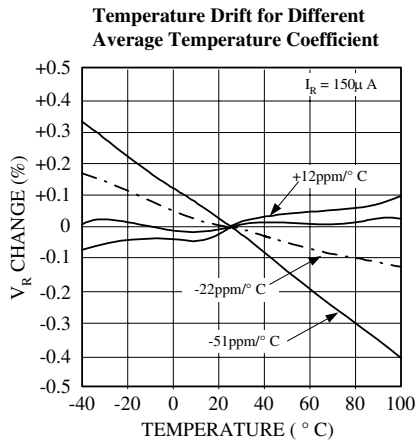

PACKAGE DIMENSIONS inches (millimeters) unless otherwise noted.

3 LEAD SOT-23 PLASTIC PACKAGE (M)

