

END-LOOK PACKAGE PHOTOTRANSISTOR

● Features

1. Wide range of collector current.
2. high sensitivity.
3. Low cost plastic package.
4. Lens Appearance: Water Clear.
5. This product doesn't contain restriction substance, comply ROHS standard

● Description

The BPT-BP1334 is a NPN silicon phototransistor mounted in a lensed , special dark plastic package .

The lensing effect of the package allows an acceptance half view angle of 35° that is measured from the optical axis to the half power point .

● Package Dimensions:

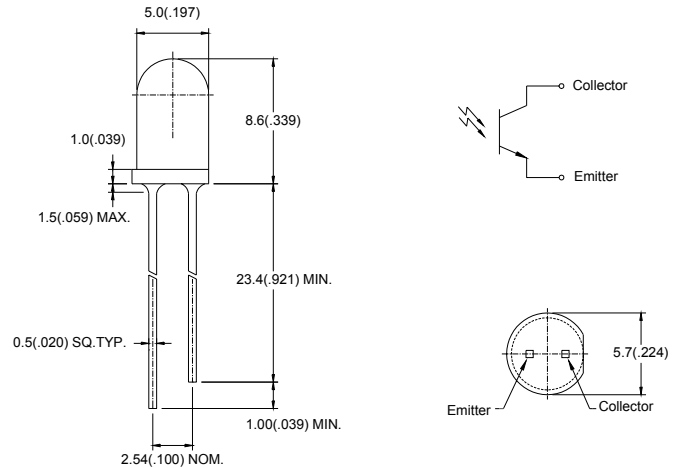

NOTES:

- 1.All dimensions are in millimeters (inches).
- 2.Tolerance is $\pm 0.25\text{mm}$ (0.01') unless otherwise specified.
- 3.Lead spacing is measured where the leads emerge from the package
- 4.Specifications are subject to change without notice

● Absolute Maximum Ratings($T_a=25^\circ\text{C}$)

Parameter	Maximum Rating	Unit
Power Dissipation	100	mW
Collector- Emitter Voltage	30	V
Emitter- Collector Voltage	5	V
Operating Temperature	$-45^\circ\text{C} \sim +85^\circ\text{C}$	
Storage Temperature Range	$-45^\circ\text{C} \sim +100^\circ\text{C}$	
Lead Soldering Temperature	260°C for 5 seconds	

● **Electrical Characteristics** (TA=25°C unless otherwise noted)

PARAMETER	SYMBOL	MIN	TYP	MAX	UNITS	TEST CONDITIONS
Collector- Emitter Breakdown Voltage	$V_{(BR)CEO}$	30	-	-	V	$I_C=0.1mA$ $E_e=0mW/cm^2$
Emitter-Collector Breakdown Voltage	$V_{(BR)ECO}$	5	-	-	V	$I_R=0.1mA$ $E_e=0 mW/cm^2$
Collector- Emitter Saturation Voltage	$V_{CE(SAT)}$	-	-	0.5	V	$I_C=0.1 mA$ $E_e=1.0 mW/cm^2$
Rise Time	T_r	-	15	-	μS	$V_{CC}=5V$ $R_L=1K\Omega$ $I_C=1mA$
Fall Time	T_f	-	15	-	μS	$V_{CC}=5V$ $R_L=1K\Omega$ $I_C=1mA$
Collector Dark Current	I_{CEO}	-	-	100	nA	$V_{CE}=10V$ $E_e=0 mW/cm^2$
On State Collector Current	$I_{C(ON)}$	-	13.5	-	mA	$V_{CE}=5V$ $E_e=1.0mW/cm^2$

● **Typical Optical-Electrical Characteristic Curves**

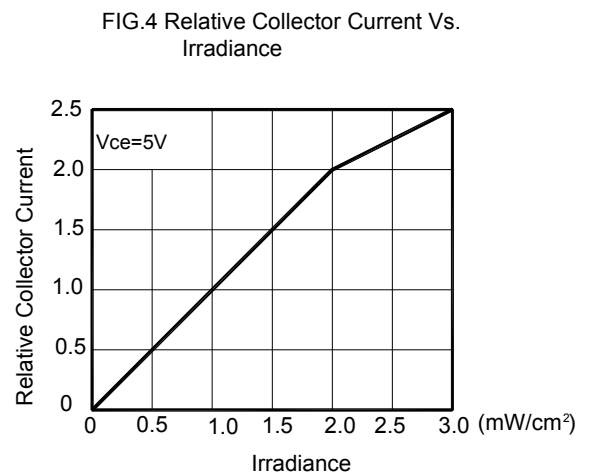
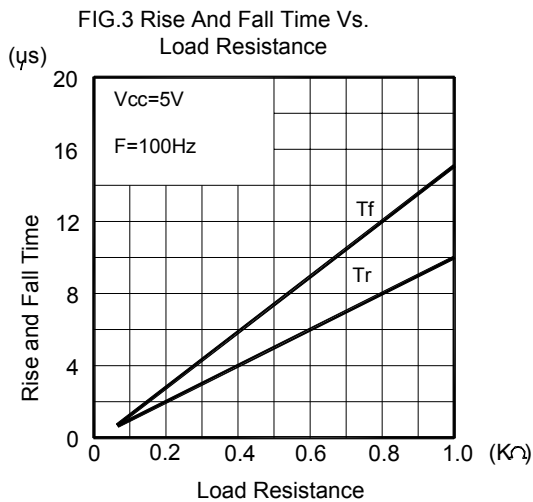
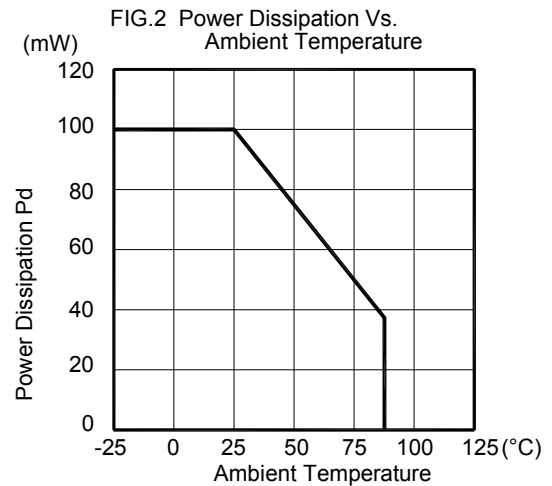
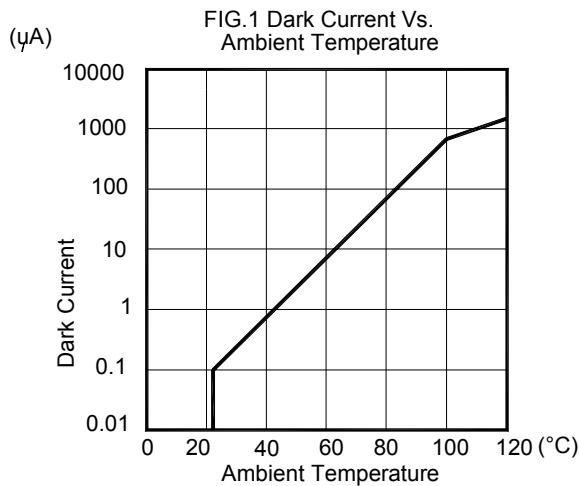

● Tapping and packaging specifications(Units: mm)

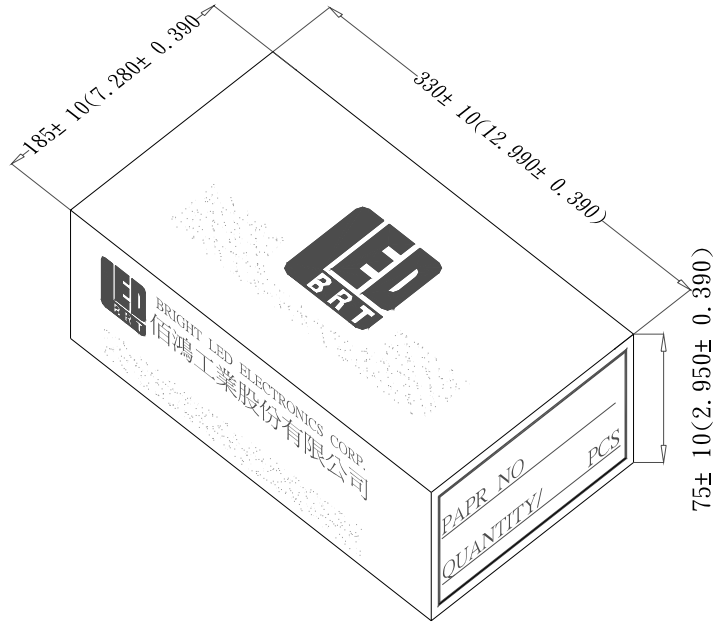

● Packaging Bag Dimensions

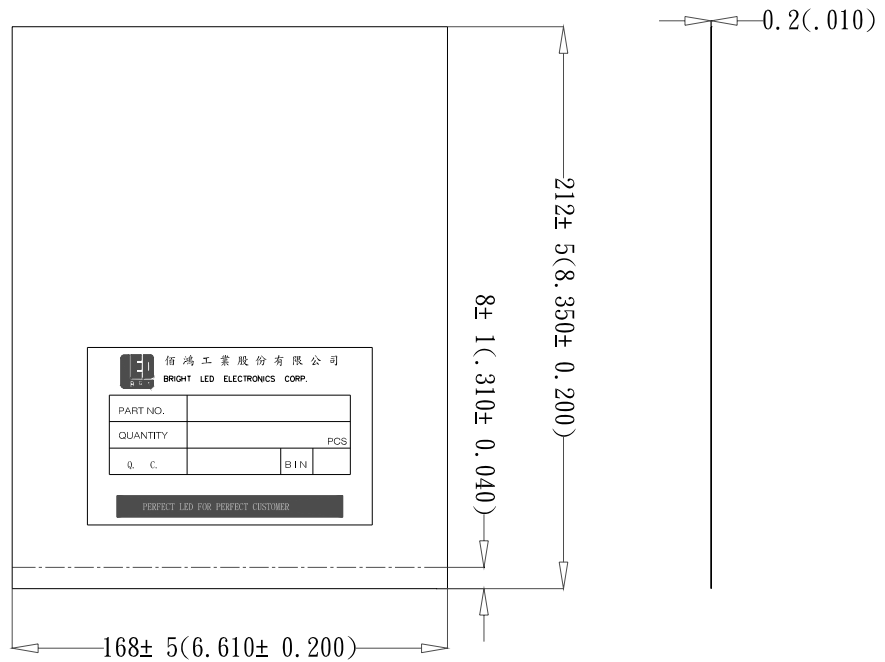

Notes:

- 1、500pcs per bag, 5Kpcs per box.
- 2、All dimensions are in millimeters(inches).
- 3、Specifications are subject to change without notice.