

# BRIGHT LED ELECTRONICS CORP.

## LED LAMPS SPECIFICATION

●COMMODITY : T-13/4 Narrow Viewing Angle 1.0°Lead,5 φ

●DEVICE NUMBER : BL-BJ53J7M

PAGE: 2

●ELECTRICAL AND OPTICAL CHARACTERISTICS (Ta=25°C)

VERSION : 1.0

Chip		Lens Appearance	Absolute Maximum Rating				Electro-optical Data (At 20mA)			Viewing Angle 2θ 1/2 (deg)
Emitted Color	Peak Wave Length λ P(nm)		Δ λ (nm)	Pd (mW)	If (mA)	Peak If (mA)	Vf(V)		Iv Typ. (mcd)	
							Typ.	Max.		
Super Orange	610	Water Clear	17	65	30	150	2.0	2.6	4000	8

Remark : Viewing angle is the Off-axis angle at which the luminous intensity is half the axial luminous intensity.

### ●ABSOLUTE MAXIMUM RATINGS (Ta=25°C)

Reverse Voltage .....	5V
Reverse Current (-Vr=5V) .....	100μA
Operating Temperature Range .....	-40°C ~ 80°C
Storage Temperature Range .....	-40°C ~ 85°C
Lead Soldering Temperature .....	260°C For 5 Seconds

### ●PACKAGE DIMENSIONS

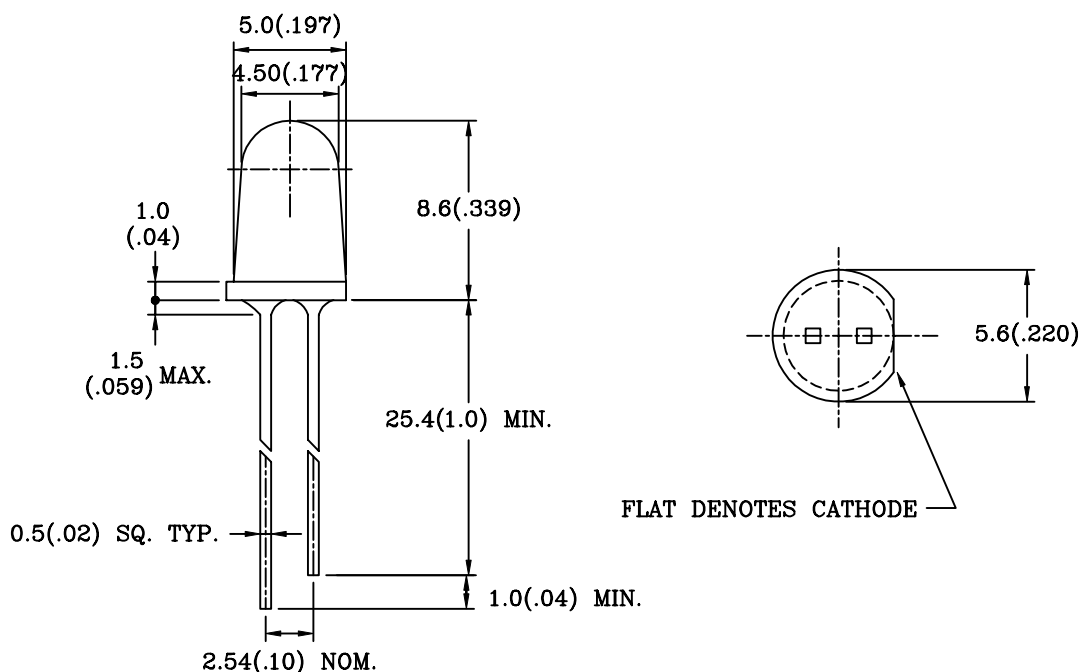

NOTES: 1.All dimensions are in millimeters (inches).

2.Tolerance is ± 0.25mm (0.01") unless otherwise specified.

3.Lead spacing is measured where the leads emerge from the package.

4.Specifications are subject to change without notice.

# BRIGHT LED ELECTRONICS CORP.

## LED LAMP SPECIFICATION

● COMMODITY:T-1 3/4 Narrow Viewing Angle 1.0" Lead 5 $\phi$

● DEVICE NUMBER: BL-BJ53J7M

PAGE: 3

● ELECTRICAL AND OPTICAL CHARACTERISTICS(Ta=25°C)

REVISION:1.0

SPECTRAL DISTRIBUTION

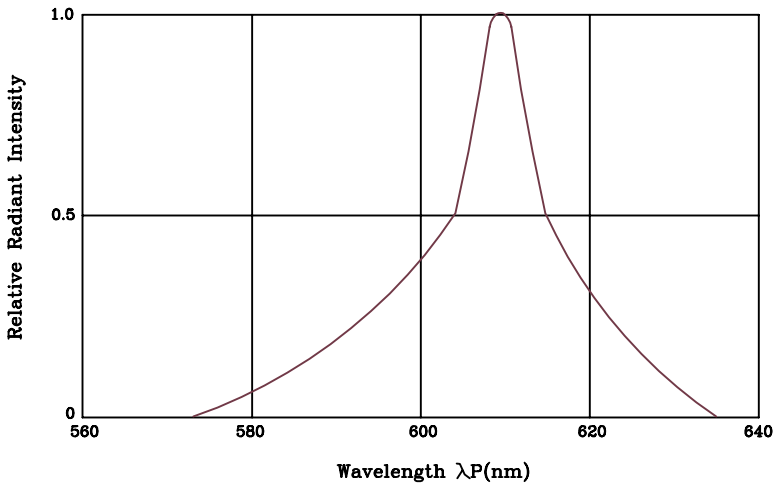

FORWARD CURRENT DERATING CURVE

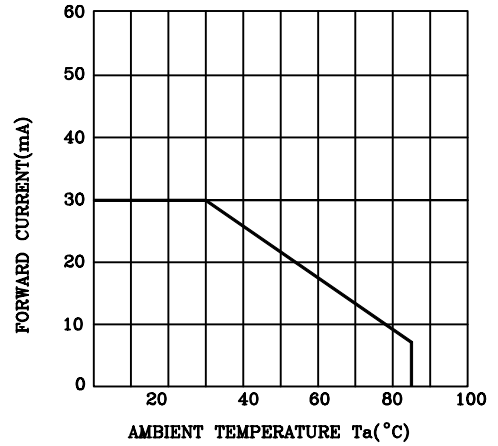

PEAK FORWARD VOLTAGE VS. FORWARD CURRENT

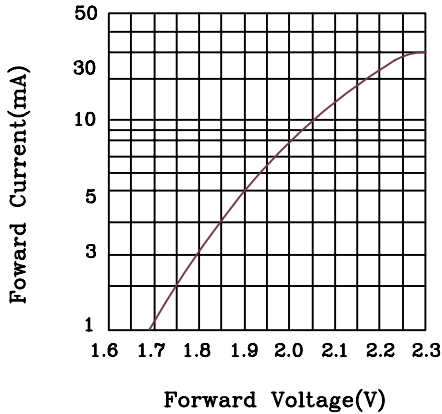

RELATIVE INTENSITY VS. LEAD TEMPERATURE

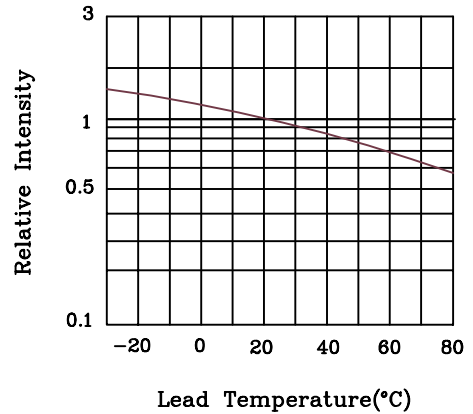

FORWARD CURRENT VS. AMBIENT TEMPERATURE

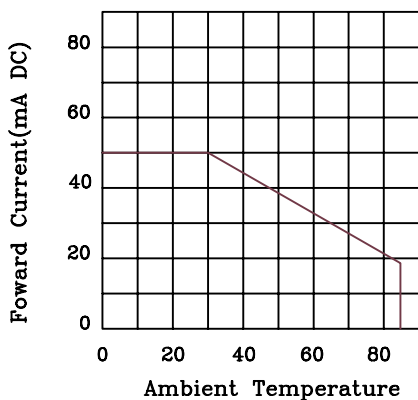

RADIANT DIAGRAM

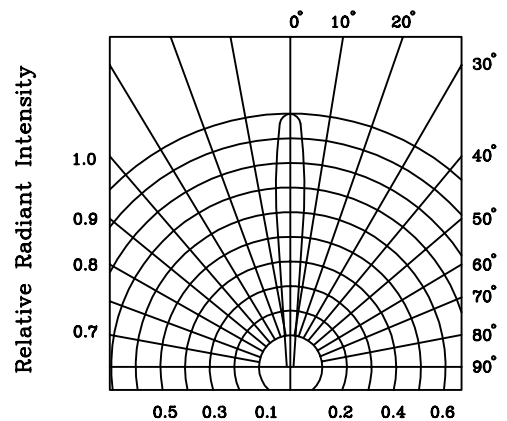

# BRIGHT LED ELECTRONICS CORP.

## LED LAMP SPECIFICATION

### RELIABILITY TEST

PAGE: 4

REVISION: 1.0

Classification	Test Item	Reference Standard	Test Conditions	Result
Endurance Test	Operation Life	MIL-STD-750:1026 MIL-STD-883:1005 JIS C 7021 :B-1	Connect with a power $I_f=30\text{mA}$ $T_a$ =Under room temperature Test time=1,000hrs	0/100
	High Temperature High Humidity Storage	MIL-STD-202:103B JIS C 7021 :B-11	$T_a=85^\circ\text{C}\pm 5^\circ\text{C}$ RH=90%-95% Test time=1,000hrs	0/100
	High Temperature Storage	MIL-STD-883:1008 JIS C 7021 :B-10	High $T_a=105^\circ\text{C}\pm 5^\circ\text{C}$ Test time=1,000hrs	0/100
	Low Temperature Storage	JIS-C-7021 :B-12	Low $T_a=-55^\circ\text{C}\pm 5^\circ\text{C}$ Test time=1,000hrs	0/100
Environmental Test	Temperature Cycling	MIL-STD-202:107D MIL-STD-750:1051 MIL-STD-883:1010 JIS C 7021 :A-4	$-35^\circ\text{C} \sim 25^\circ\text{C} \sim 85^\circ\text{C} \sim 25^\circ\text{C}$ 30min 5min 30min 5min Test Time=10cycle	0/100
	Thermal Shock	MIL-STD-202:107D MIL-STD-750:1051 MIL-STD-883:1011	$105^\circ\text{C}\pm 5^\circ\text{C} \sim -55^\circ\text{C}\pm 5^\circ\text{C}$ 10min 10min Test Time=10cycle	0/100
	Solder Resistance	MIL-STD-202:201A MIL-STD-750:2031 JIS C 7021 :A-1	$T_{\text{sol}}=260\pm 5^\circ\text{C}$ Dwell Time= $10\pm 1\text{sec}$ .	0/50
	Solderability	MIL-STD-202:208D MIL-STD-750:2026 MIL-STD-883:2003 JIS C 7021 :A-2	$T_{\text{sol}}=230\pm 5^\circ\text{C}$ Dwell Time= $5\pm 1\text{sec}$ .	0/50
	Lead Bending Stress	MIL-STD-750:2036 JIS C 7021 :A-11	$0^\circ\sim 90^\circ\sim 0^\circ$ bend , 3 cycles Weight 250g	0/50

### JUDGMENT CRITERIA OF FAILURE FOR THE RELIABILITY

Measuring items	Symbol	Measuring conditions	Judgement criteria for failure
Forward voltage	VF	$I_F=20\text{mA}$	Over $U_x1.2$
Reverse current	IR	$V_R=5\text{V}$	Over $U_x2$
Luminous intensity	IV	$I_F=20\text{mA}$	Below $S_x0.5$

Note: 1.U means the upper limit of specified characteristics. S means initial value.

2.Measurment shall be taken between 2 hours and after the test pieces have been returned to normal ambient conditions after completion of each test.