

BRIGHT LED ELECTRONICS CORP.

LED LAMPS SPECIFICATION

PAGE: 2

VERSION : 1.0

- COMMODITY : T-1x3/4 1.0"Lead, Narrow Viewing 5 φ
- DEVICE NUMBER : BL-BF43R7M
- ELECTRICAL AND OPTICAL CHARACTERISTICS (Ta=25°C)

Chip		Lens Appearance	Absolute Maximum Rating				Electro-optical Data (At 20mA)			Viewing Angle 2 θ 1/2 (deg)
Emitted Color	Peak Wave Length λ P(nm)		Δ λ (nm)	Pd (mW)	If (mA)	Peak If(mA)	Vf(V)		Iv Typ. (mcd)	
							Typ.	Max.		
Ultra Red	660	Water Clear	20	65	30	150	2.0	2.6	4000	8

Remark : Viewing angle is the Off-axis angle at which the luminous intensity is half the axial luminous intensity.

● ABSOLUTE MAXIMUN RATINGS (Ta=25°C)

Reverse Voltage	5V
Reverse Current (-Vr=5V)	100μA
Operating Temperature Range	-40°C ~ 80°C
Storage Temperature Range	-40°C ~ 85°C
Lead Soldering Temperature	260°C For 5 Seconds

● PACKAGE DIMENSIONS

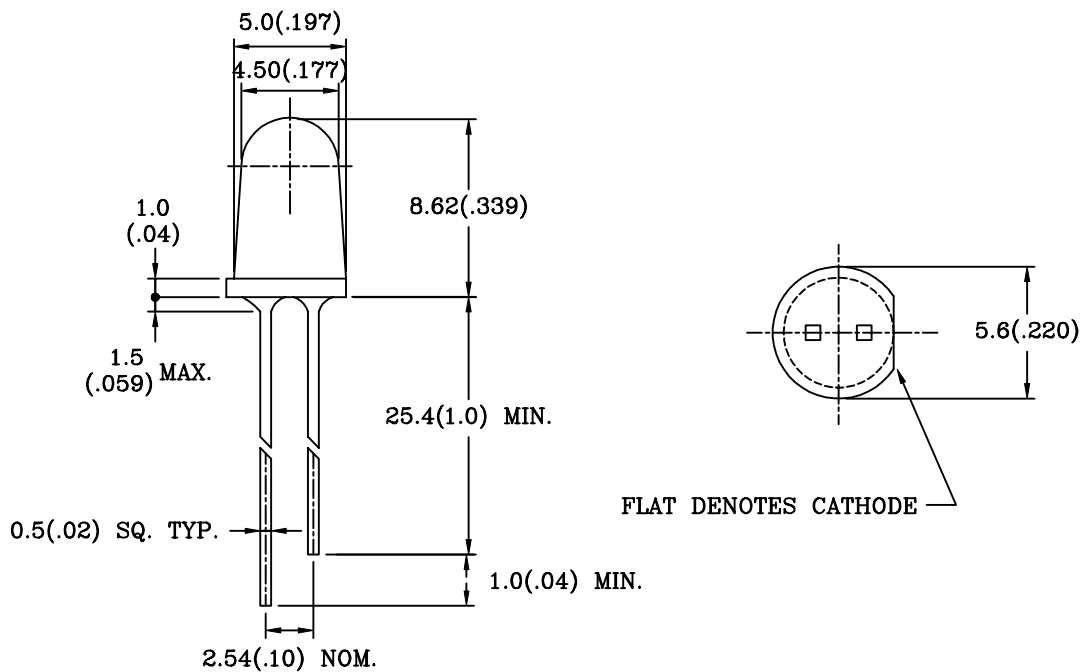

NOTES: 1.All dimensions are in millimeters (inches).

2.Tolerance is ± 0.25mm (0.01") unless otherwise specified.

3.Lead spacing is measured where the leads emerge from the package.

4.Specifications are subject to change without notice.

BRIGHT LED ELECTRONICS CORP.

LED LAMPS SPECIFICATION

- COMMODITY: T-1 3/4 Narrow Viewing 1.0"Lead,5 ϕ
- DEVICE NUMBER: BL-BF43R7M
- ELECTRICAL AND OPTICAL CHARACTERISTICS(T_a=25 C)

PAGE: 3

REVISION: 1.0

SPECTRAL DISTRIBUTION

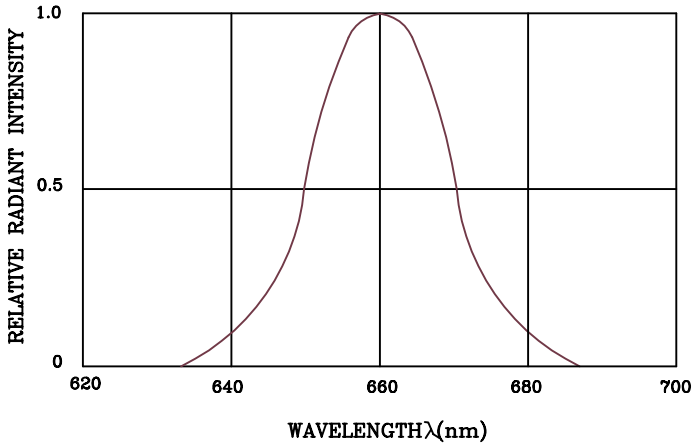

FORWARD CURRENT DERATING CURVE

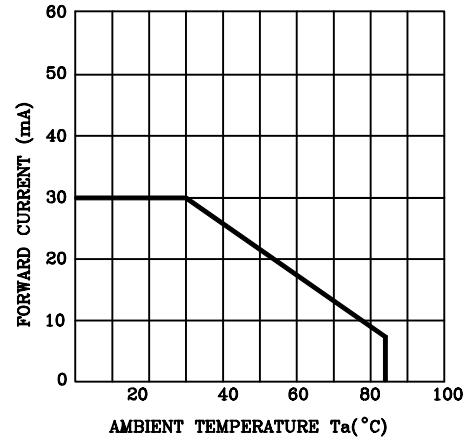

FORWARD CURRENT VS. FORWARD VOLTAGE

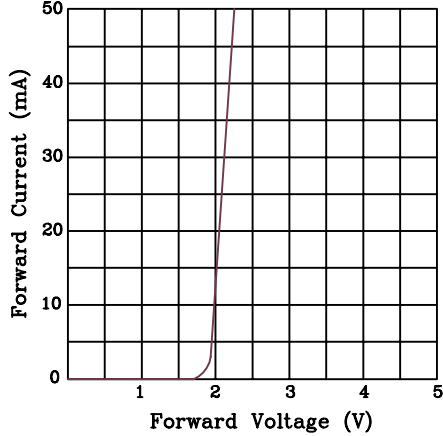

RELATIVE RADIANT INTENSITY VS. AMBIENT TEMPERATURE

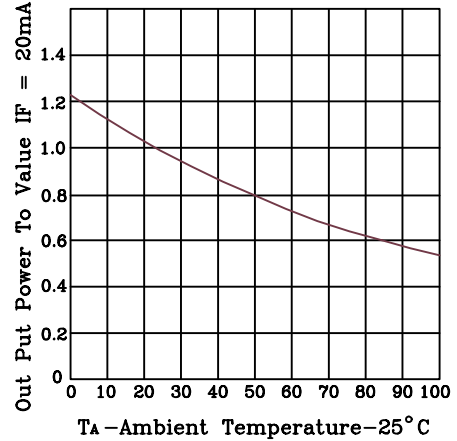

RELATIVE RADIANT INTENSITY VS. FORWARD CURRENT

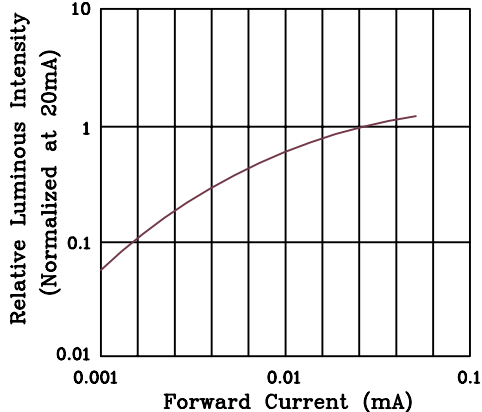

RADIATION DIAGRAM

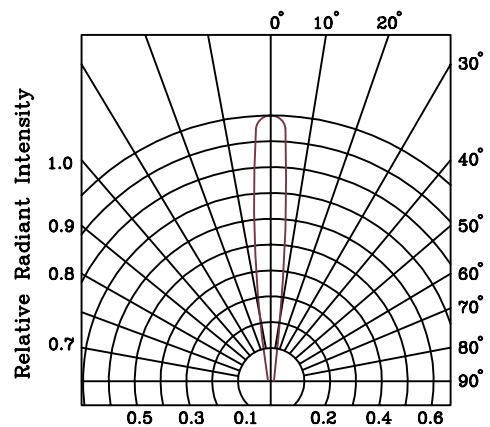

BRIGHT LED ELECTRONICS CORP.

LED LAMP SPECIFICATION

RELIABILITY TEST

PAGE: 4

REVISION: 1.0

Classification	Test Item	Reference Standard	Test Conditions	Result
Endurance Test	Operation Life	MIL-STD-750:1026 MIL-STD-883:1005 JIS C 7021 :B-1	Connect with a power If=30mA Ta=Under room temperature Test time=1,000hrs	0/100
	High Temperature High Humidity Storage	MIL-STD-202:103B JIS C 7021 :B-11	Ta=85°C±5°C RH=90%-95% Test time=1,000hrs	0/100
	High Temperature Storage	MIL-STD-883:1008 JIS C 7021 :B-10	High Ta=85°C±5°C Test time=1,000hrs	0/100
	Low Temperature Storage	JIS-C-7021 :B-12	Low Ta=-35°C±5°C Test time=1,000hrs	0/100
Environmental Test	Temperature Cycling	MIL-STD-202:107D MIL-STD-750:1051 MIL-STD-883:1010 JIS C 7021 :A-4	-35°C ~ 25°C ~ 85°C ~ 25°C 30min 5min 30min 5min Test Time=10cycle	0/100
	Thermal Shock	MIL-STD-202:107D MIL-STD-750:1051 MIL-STD-883:1011	85°C±5°C ~ -35°C±5°C 10min 10min Test Time=10cycle	0/100
	Solder Resistance	MIL-STD-202:201A MIL-STD-750:2031 JIS C 7021 :A-1	T.sol=260±5°C Dwell Time=10±1sec.	0/50
	Solderability	MIL-STD-202:208D MIL-STD-750:2026 MIL-STD-883:2003 JIS C 7021 :A-2	T.sol=230±5°C Dwell Time=5±1sec.	0/50
	Lead Bending Stress	MIL-STD-750:2036 JIS C 7021 :A-11	0°~90°~0°bend , 3 cycles Weight 250g	0/50

JUDGMENT CRITERIA OF FAILURE FOR THE RELIABILITY

Measuring items	Symbol	Measuring conditions	Judgement criteria for failure
Forward voltage	VF	IF=20mA	Over Ux1.2
Reverse current	IR	VR=5V	Over Ux2
Luminous intensity	IV	IF=20mA	Below Sx0.5

Note: 1.U means the upper limit of specified characteristics. S means initial value.

2.Measurment shall be taken between 2 hours and after the test pieces have been returned to normal ambient conditions after completion of each test.