

## ● Features:

1. Emitted Color: Super Red.
2. Lens Appearance: Water Clear.
3. Low cost plastic package.
4. This product doesn't contain restriction Substance, comply ROHS standard.

## ● Applications:

1. Automotive: Dashboards, stop lamps, turn signals.
2. Backlighting: LCDs, Key pads advertising.
3. Status indicators: Consumer & industrial electronics.
4. General use.

## ● Package Dimensions:

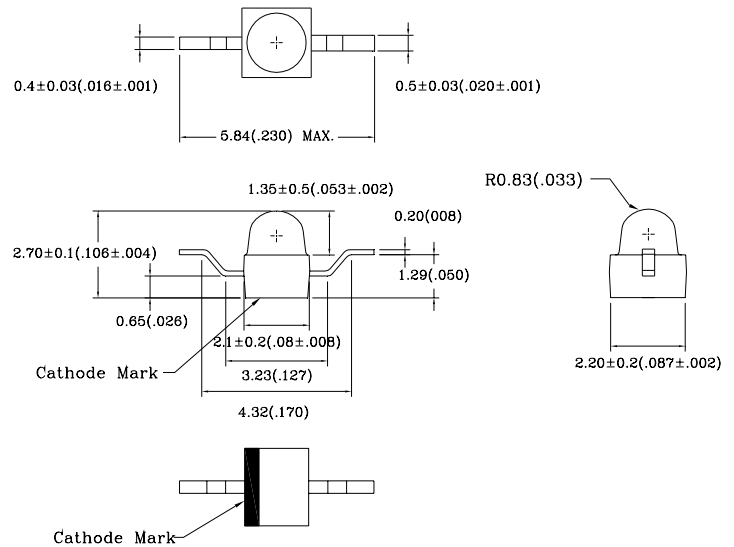

## NOTES:

1. All dimensions are in millimeters (inches).
2. Tolerance is  $\pm 0.10$ mm (0.004") unless otherwise specified.
3. Specifications are subject to change without notice.

## ● Absolute Maximum Ratings(Ta=25°C)

| Parameter                | Symbol          | Rating       | Unit |
|--------------------------|-----------------|--------------|------|
| Power Dissipation        | Pd              | 65           | mW   |
| Forward Current          | I <sub>F</sub>  | 30           | mA   |
| Peak Forward Current * 1 | I <sub>FP</sub> | 100          | mA   |
| Reverse Volage           | V <sub>R</sub>  | 5            | V    |
| Operating Temperature    | Topr            | -25°C ~ 80°C | -    |
| Storage Temperature      | Tstg            | -30°C ~ 85°C | -    |
| Soldering Temperature    | Tsol            | See Page 5   | -    |

\* 1 Condition for I<sub>FP</sub> is pulse of 1/10 duty and 0.1msec width.

## ● Electrical and optical characteristics(Ta=25°C)

| Parameter                | Symbol            | Condition            | Min. | Typ. | Max. | Unit |
|--------------------------|-------------------|----------------------|------|------|------|------|
| Forward Voltage          | V <sub>f</sub>    | I <sub>F</sub> =20mA | -    | 2.1  | 2.6  | V    |
| Luminous Intensity       | I <sub>v</sub>    | I <sub>F</sub> =20mA | 42   | 100  | -    | mcd  |
| Reverse Current          | I <sub>R</sub>    | V <sub>R</sub> =5V   | -    | -    | 100  | μA   |
| Peak Wave Length         | λ <sub>p</sub>    | I <sub>F</sub> =20mA | -    | 660  | -    | nm   |
| Dominant Wave Length     | λ <sub>d</sub>    | I <sub>F</sub> =20mA | 638  |      | 648  | nm   |
| Spectral Line Half-width | Δλ                | I <sub>F</sub> =20mA | -    | 20   | -    | nm   |
| Veiwng Angle             | 2θ <sub>1/2</sub> | I <sub>F</sub> =20mA | -    | 35   | -    | deg  |

## ● Typical Electro-Optical Characteristics Curves

Fig.1 RELATIVE INTENSITY VS. WAVELENGTH

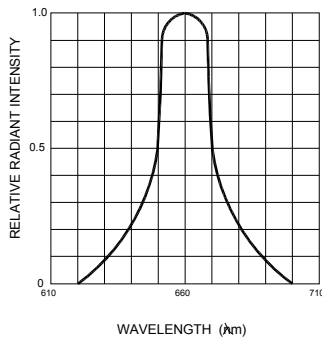

Fig.2 FORWARD CURRENT DERATING CURVE

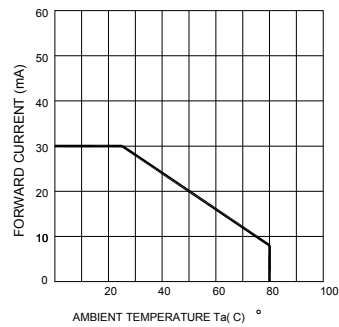

Fig.3 FORWARD CURRENT VS. FORWARD VOLTAGE

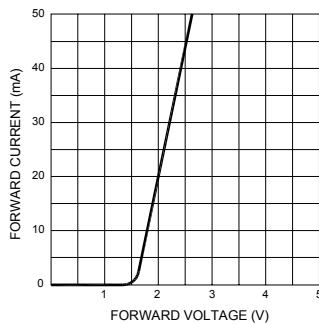

Fig.4 RELATIVE LUMINOUS INTENSITY VS. AMBIENT TEMPERATURE

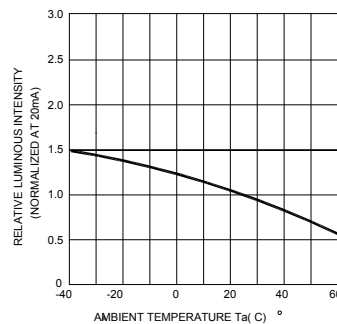

Fig.5 RELATIVE LUMINOUS INTENSITY VS. FORWARD CURRENT

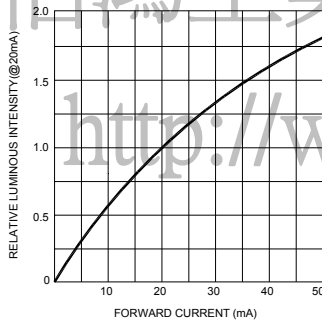
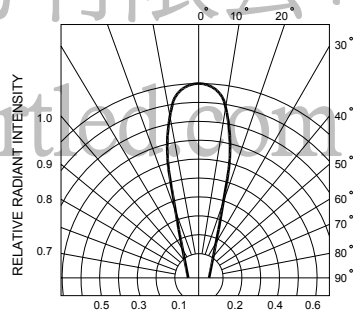
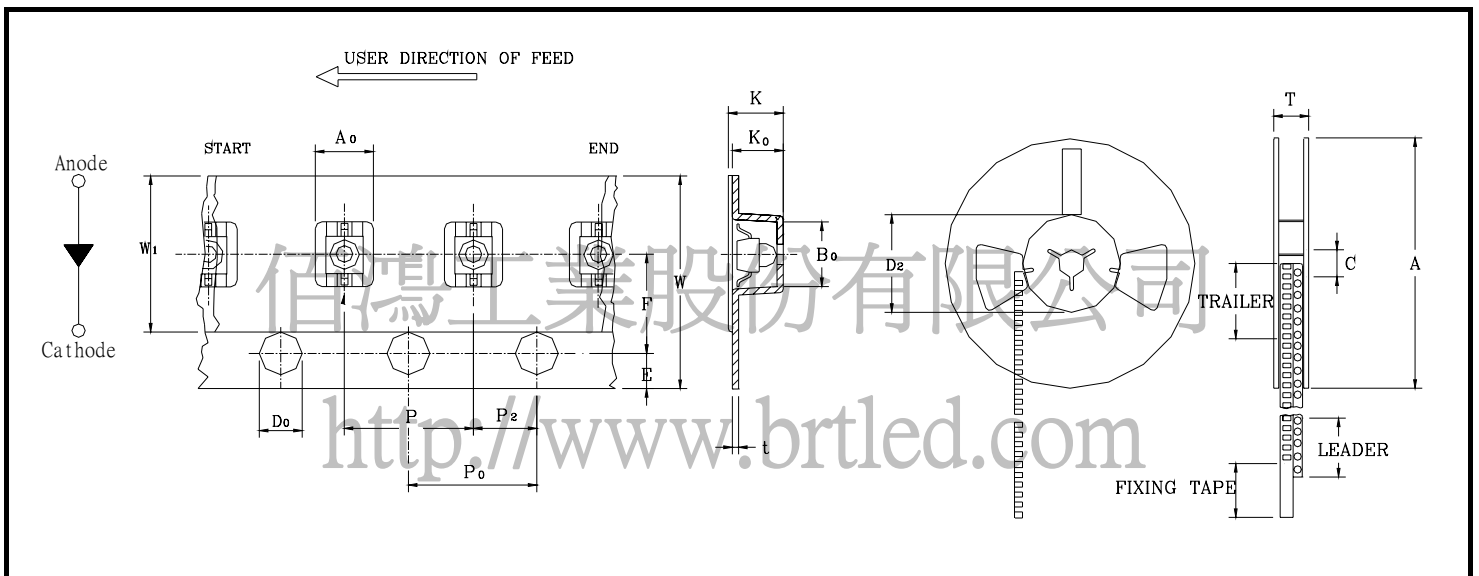

Fig.6 RADIATION DIAGRAM



● Tapping and packaging specifications(Units: mm)

| ITEM                                     | SYMBOL | SPECIFICATION |       |         |       |
|--|--------|---------------|-------|---------|-------|
|  |        | Minimum       |       | Maximum |       |
|  |        | mm            | inch  | mm      | inch  |
| Tape Feed Hole Diameter (DIA)            | $D_0$  | 1.40          | 0.055 | 1.55    | 0.061 |
| Feed Hole Location                       | E      | 1.65          | 0.065 | 1.85    | 0.072 |
| Centers Line Dimensions Length Direction | F      | 5.45          | 0.215 | 5.55    | 0.218 |
| Compartment Depth                        | $K_0$  | 3.10          | 0.122 | 3.30    | 0.130 |
| Carrier Tape Overall Thickness           | K      | 3.00          | 0.118 | 3.20    | 0.126 |
| Compartment Pitch                        | P      | 3.90          | 0.153 | 4.10    | 0.161 |
| Sprocket Hole Diameter                   | $P_0$  | 3.90          | 0.153 | 4.10    | 0.161 |
| Centers Line Dimensions Length Direction | $P_2$  | 1.95          | 0.076 | 2.05    | 0.080 |
| Carrier Tape Thickness                   | t      | —             | —     | 0.30    | 0.012 |
| Carrier Tape Width                       | W      | 12.00         | 0.472 | 12.30   | 0.484 |
| Flange Diameter                          | A      | 178.0         | 7.008 | 180.0   | 7.087 |
| Hub Spindle Hole                         | C      | 12.50         | 0.492 | 13.50   | 0.531 |
| Hub Diameter                             | $D_2$  | 20.00         | 0.788 | 21.50   | 0.846 |
| Fixing Tape Width                        | $W_1$  | 9.00          | 0.354 | 9.30    | 0.366 |
| Flange Space Between Flanges             | T      | 16.00         | 0.629 | 17.00   | 0.669 |
| Compartment Length                       | $A_0$  | 2.20          | 0.087 | 2.40    | 0.094 |
| Compartment Width                        | $B_0$  | 3.90          | 0.154 | 4.10    | 0.161 |



## ● Reliability Test

| Classification     | Test Item                              | Reference Standard  | Test Conditions  | Result |
|--------------------|--|---|--|--------|
| Endurance Test     | Operation Life                         | MIL-STD-750:1026<br>MIL-STD-883:1005<br>JIS-C-7021 :B-1                     | Connect with a power $I_f=20\text{mA}$<br>$T_a$ =Under room temperature<br>Test time=1,000hrs  | 0/20   |
|                    | High Temperature High Humidity Storage | MIL-STD-202:103B<br>JIS-C-7021 :B-11  | $T_a=+65^\circ\text{C}\pm 5^\circ\text{C}$<br>RH=90%-95%<br>Test time=240hrs   | 0/20   |
|                    | High Temperature Storage               | MIL-STD-883:1008<br>JIS-C-7021 :B-10  | High $T_a=+85^\circ\text{C}\pm 5^\circ\text{C}$<br>Test time=1,000hrs  | 0/20   |
|                    | Low Temperature Storage                | JIS-C-7021 :B-12  | Low $T_a=-35^\circ\text{C}\pm 5^\circ\text{C}$<br>Test time=1,000hrs   | 0/20   |
| Environmental Test | Temperature Cycling                    | MIL-STD-202:107D<br>MIL-STD-750:1051<br>MIL-STD-883:1010<br>JIS-C-7021 :A-4 | $-35^\circ\text{C} \sim +25^\circ\text{C} \sim +85^\circ\text{C} \sim +25^\circ\text{C}$<br>60min 20min 60min 20min<br>Test Time=5cycle                  | 0/20   |
|                    | Thermal Shock                          | MIL-STD-202:107D<br>MIL-STD-750:1051<br>MIL-STD-883:1011                    | $-35^\circ\text{C}\pm 5^\circ\text{C} \sim +85^\circ\text{C}\pm 5^\circ\text{C}$<br>20min 20min<br>Test Time=10cycle                                     | 0/20   |
|                    | Solder Resistance                      | MIL-STD-202:201A<br>MIL-STD-750:2031<br>JIS-C-7021 :A-1                     | Preheating :<br>$140^\circ\text{C}-160^\circ\text{C}$ , within 2 minutes.<br>Operation heating :<br>$260^\circ\text{C}$ (Max.), within 10seconds. (Max.) | 0/20   |

## ● Judgment criteria of failure for the reliability

| Measuring items    | Symbol                  | Measuring conditions | Judgement criteria for failure |
|--------------------|-------------------------|----------------------|--------------------------------|
| Forward voltage    | $V_F$ ( V )             | $I_F=20\text{mA}$    | Over $U_x1.2$                  |
| Reverse current    | $I_R$ ( $\mu\text{A}$ ) | $V_R=5\text{V}$      | Over $U_x2$                    |
| Luminous intensity | $I_v$ ( mcd )           | $I_F=20\text{mA}$    | Below $SX0.5$                  |

Note: 1.U means the upper limit of specified characteristics. S means initial value.

2. Measurement shall be taken between 2 hours and after the test pieces have been returned to normal ambient conditions after completion of each test.

## ● Soldering :

### 1. Manual of Soldering

The temperature of the iron tip should not be higher than 300°C (572°F) and Soldering within 3 seconds per solder-land is to be observed.

### 2. Reflow Soldering

Preheating : 140°C~160°C ±5°C ,within 2 minutes.

Operation heating : 260°C (Max.) within 10 seconds.(Max)

Gradual Cooling (Avoid quenching).

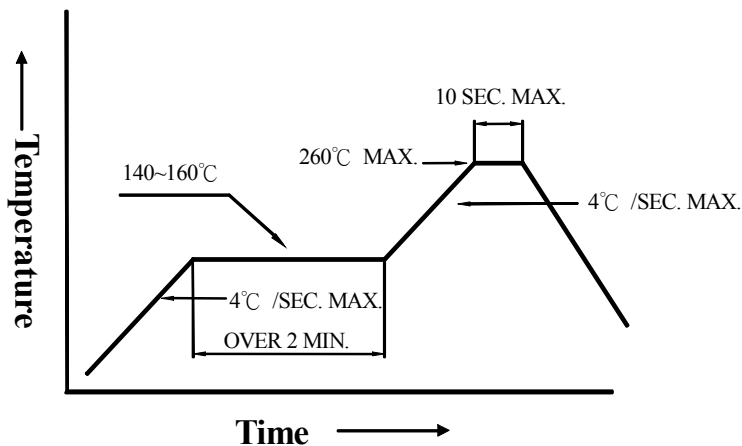

### 3. DIP soldering (Wave Soldering) :

Preheating : 120°C~150°C,within 120~180 sec.

Operation heating : 245°C±5°C within 5 sec.260°C (Max)

Gradual Cooling (Avoid quenching).

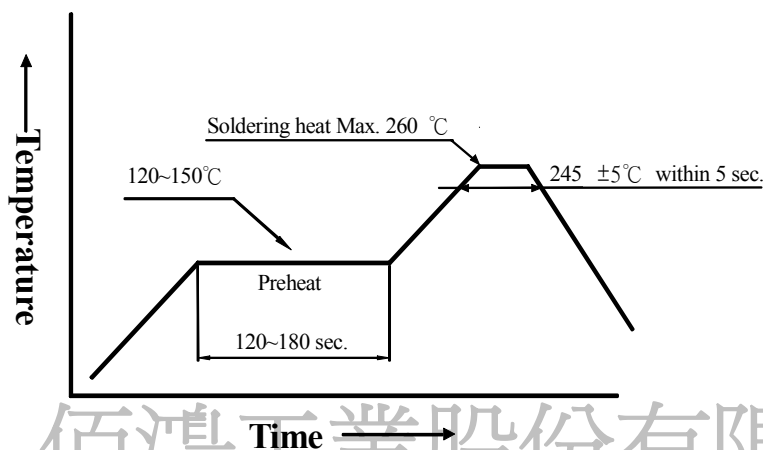

## ● Handling :

Care must be taken not to cause to the epoxy resin portion of BRIGHT LEDs while it is exposed to high temperature.

Care must be taken not rub the epoxy resin portion of BRIGHT LEDs with hard or sharp article such as the sand blast and the metal hook.

佰鴻工業股份有限公司

<http://www.brtled.com>

● **Notes for designing:**

Care must be taken to provide the current limiting resistor in the circuit so as to drive the BRIGHT LEDs within the rated figures. Also, caution should be taken not to overload BRIGHT LEDs with instantaneous voltage at the turning ON and OFF of the circuit.

When using the pulse drive care must be taken to keep the average current within the rated figures. Also, the circuit should be designed so as to be subjected to reverse voltage when turning off the BRIGHT LEDs.

● **Storage:**

In order to avoid the absorption of moisture, it is recommended to solder BRIGHT LEDs as soon as possible after unpacking the sealed envelope.

If the envelope is still packed, to store it in the environment as following:

- (1) Temperature : 5°C-30°C (41°F) Humidity : RH 60% Max.
- (2) After this bag is opened, devices that will be applied to infrared reflow, vapor-phase reflow, or equivalent soldering process must be:
  - a. Completed within 24 hours.
  - b. Stored at less than 30% RH.
- (3) Devices require baking before mounting, if:
  - (2) a or (2) b is not met.
- (4) If baking is required, devices must be baked under below conditions:
  - 12 hours at 60°C±3°C.

● **Package and Label of Products:**

- (1) Package: Products are packed in one bag of 1500 pcs (one taping reel) and a label is attached on each bag.
- (2) Label:

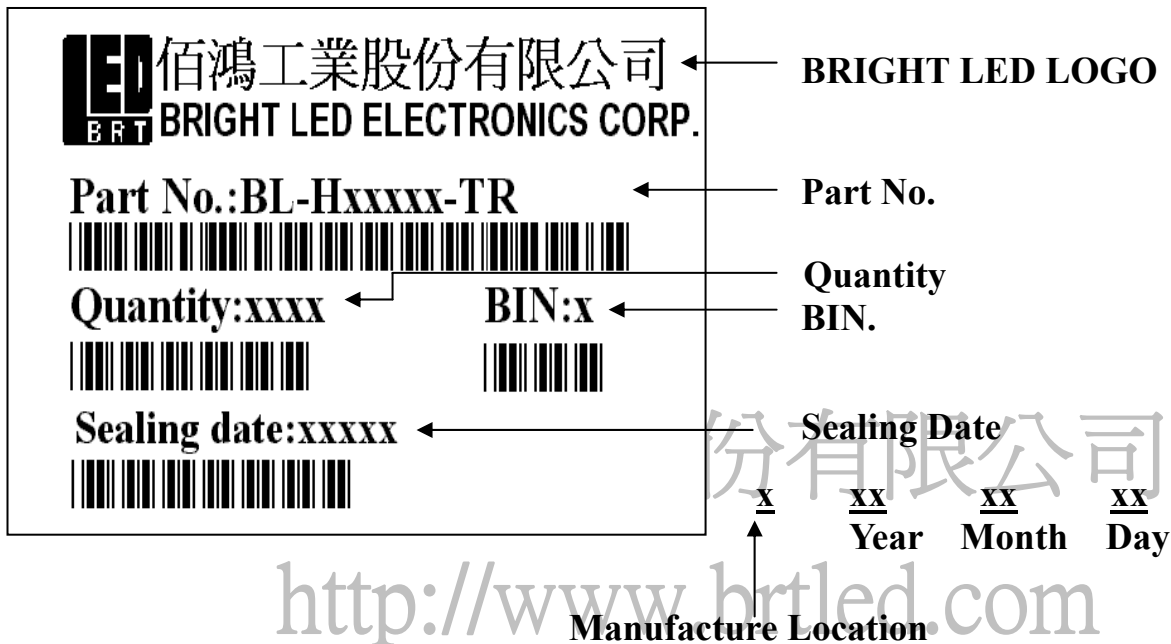

The diagram shows a rectangular label with the following fields and callouts:

- BRIGHT LED LOGO**: Points to the logo and company name at the top left.
- Part No.**: Points to the text "Part No.:BL-Hxxxxx-TR".
- Quantity**: Points to the text "Quantity:xxxx".
- BIN**: Points to the text "BIN:x".
- Sealing Date**: Points to the text "Sealing date:xxxxx".
- Manufacture Location**: Points to a barcode at the bottom left.

Below the label, the date format is shown as:              
Year Month Day

<http://www.brtled.com>