

Photoelectrics Through-beam Type PH18CNT..., DC

CARLO GAVAZZI

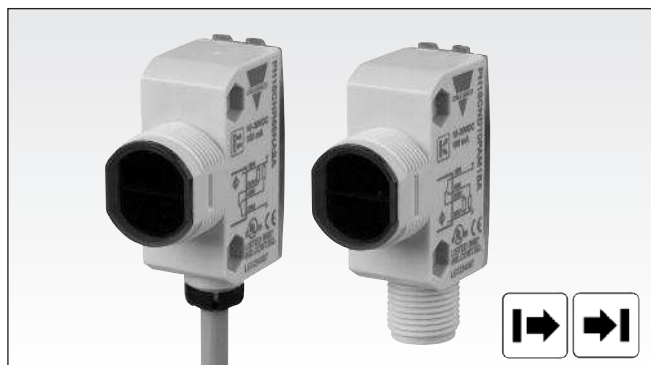

- Miniature sensor range
- Range: 20 m
- Sensitivity adjustment by potentiometer
- Modulated, infrared light 850 nm
- Supply voltage: 10 to 30 VDC
- Output: 100 mA, NPN or PNP, N.O + N.C.
- Degree of protection IP67, IP69K
- LED indication for output, stability and power ON
- Protection: reverse polarity, short circuit and transients
- Cable, plug and pigtail versions
- Excellent EMC performance



Product Description

The PH18CNT... is part of a family of inexpensive general purpose through-beam sensors in industrial standard 18 mm cylindrical and square ABS housing. The sensors are useful in applications where high-accuracy detection as well as small size is required.

Compact housing and high power LED for excellent performance-size ratio. The potentiometer used for adjustment of the sensitivity makes the sensors highly flexible. The output type is NPN or PNP and the output switching function is NO and NC.

Ordering Key

PH18CNT20PAM1SA

Type	_____
Housing style square	_____
Housing size	_____
Housing material	_____
Housing type neutral	_____
Detection principle	_____
Sensing distance	_____
Output type	_____
Output configuration	_____
Connection type	_____
Sensitive adjustment	_____

Type Selection

Housing type	Range S _n	Connec-tion	Ordering no. Emitter	Ordering no. Receiver NPN Make or break switching	Ordering no. Receiver PNP Make or break switching
M18 Square type	20 m	Cable	PH 18 CNT 20	PH 18 CNT 20 NASA	PH 18 CNT 20 PASA
M18 Square type	20 m	Plug	PH 18 CNT 20M1	PH 18 CNT 20 NAM1SA	PH 18 CNT 20 PAM1SA
M18 Square type	20 m	Pigtail M12	PH 18 CNT 20T1	PH 18 CNT 20 NAT1SA	PH 18 CNT 20 PAT1SA

Specifications Receiver according to EN60947-5-2

Rated operating distance (S_n)	Up to 20 m	OFF-state current (I_r)	≤ 100 μA
Blind zone	100 mm	Voltage drop (U_d)	≤ 2.0 VDC @ 100 mA
Sensitivity control	Adjustable by potentiometer 270°	Protection	Short-circuit, reverse polarity and transients
Adjustable distance to target	1 - 20 m	Sensing angle	± 2°
Temperature drift	≤ 0.2%/°C	Ambient light	30.000 lux Incandescent lamp
Hysteresis (H) (differential travel)	≤ 20%	Operating frequency	500 Hz
Rated operational volt. (U_B)	10 to 30 VDC (ripple included)	Response time	OFF-ON (t _{ON}) ≤ 1.0 ms ON-OFF (t _{OFF}) ≤ 1.0 ms
Ripple (U_{rpp})	≤ 10%	Power ON delay (t_v)	≤ 300 ms
Output current	Continuous (I _a) ≤ 100 mA Short-time (I) ≤ 100 mA (max. load capacity 100 nF)	Output function	Type NPN or PNP Switching function NO and NC
No load supply current (I_o)	≤ 15 mA @ 24 VDC	Indication	Output ON LED, yellow Signal stability and power ON LED, green
Minimum operational current (I_m)	0.5 mA		

Specifications Emitter according to EN60947-5-2

Rated operational volt. (U_B)	10 to 30 VDC (ripple included)	Light spot Diameter	Ø 164 mm @ 3.25 m
Ripple (U_{rpp})	≤ 10%	Protection	Reverse polarity and transients
Supply current (I_b)	≤ 23 mA @ 24 VDC	Indication function	LED, green
Light source	LED, 850 nm	Power supply ON	LED, green
Light type	Infrared, modulated	Signal stability and power ON	LED, green
Sensing angle	± 2°	Power on delay	< 300 ms

Specifications Common according to EN60947-5-2

Environment		Connection	
Installation category	III (IEC 60664/60664A; 60947-1)	Cable	PVC, grey, 2 m
Pollution degree	3 (IEC 60664/60664A; 60947-1)	Receiver	4 x 0.25 mm ² , Ø = 4.5 mm
Degree of protection	IP 67, IP 69K*	Emitter	2 x 0.25 mm ² , Ø = 4.5 mm
Ambient temperature		Plug	M12, 4-pin (CONM14NF-series)
Operating	-25° to +60°C (-13° to +140°F)	Pigtail	PUR, grey, 30 cm
Storage	-40° to +70°C (-40° to +158°F)		4 x 0.25 mm ² , Ø = 4.5 mm
Vibration	10 to 55 Hz, 0.5 mm/7.5 g (IEC 60068-2-6)	Weight	M12, 4-pin (CONM14NF-series)
Shock	30 g / 11ms, 3 pos, 3 neg per axis (IEC 60068-2-6, 60068-2-32)	With cable: 75 g	
Rated insulation voltage	500 VAC (rms) IEC protection class III 	With plug: 10 g	
Housing material		With Pigtail: 35 g	
Body	ABS, grey	CE-marking	Yes
Front material	PMMA, red	Approvals	cULus (UL508) supply class 2

* The IP69K test according to DIN 40050-9 for high-pressure, high-temperature wash-down applications. The sensor must not only be dust tight (IP6X), but also able to withstand high-pressure and steam cleaning. The sensor is exposed to high pressure water from a spray nozzle that is fed with 80°C water at 8'000–10'000 KPa (80–100bar) and a flow rate of 14–6L/min. The nozzle is held 100–150 mm from the sensor at angles of 0°, 30°, 60° and 90° for 30s each. The test device sits on a turntable that rotates with a speed of 5 times per minute. The sensor must not suffer any damaging effects from the high pressure water in appearance and function.



Wiring Diagrams

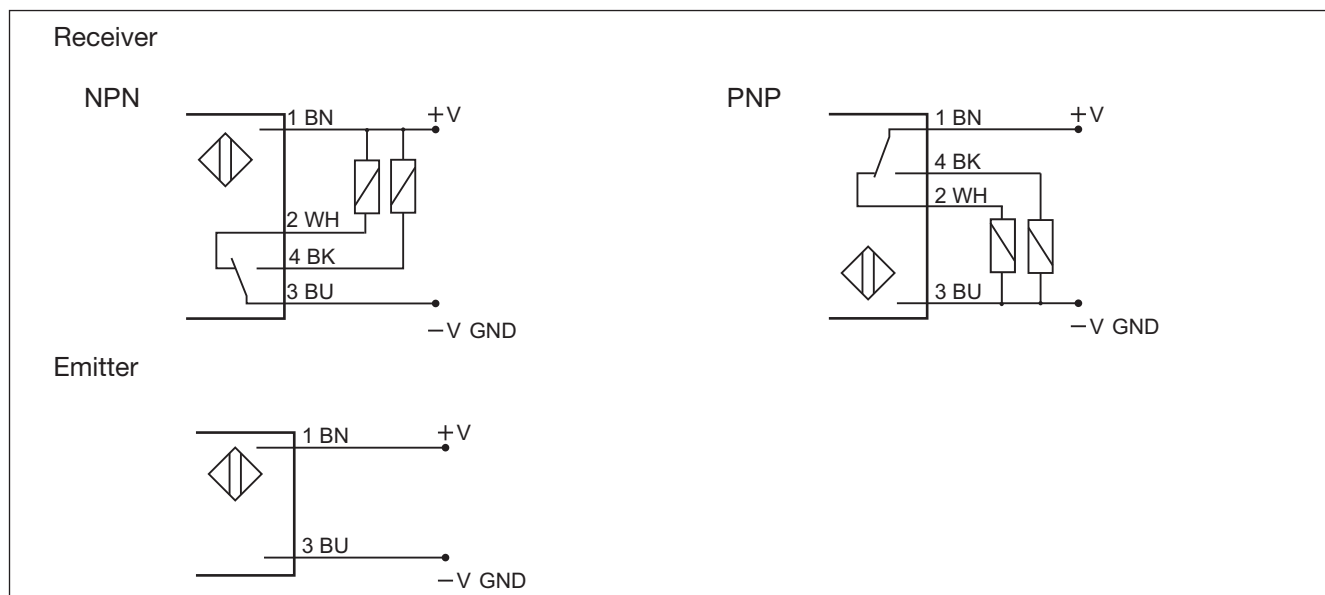

Operation Diagram

tv = Power ON delay

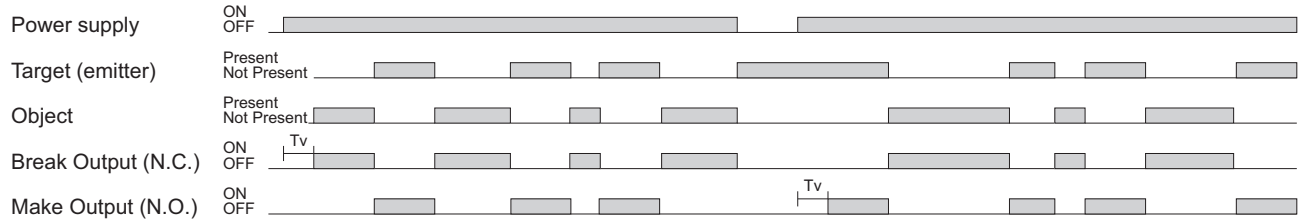

Detection Diagram

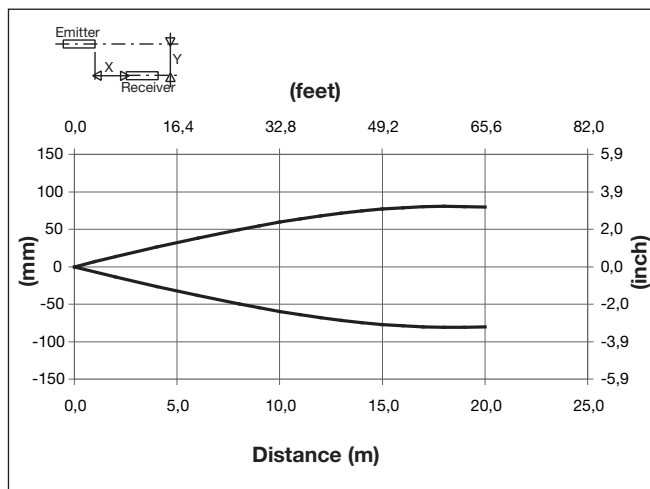

Excess Gain

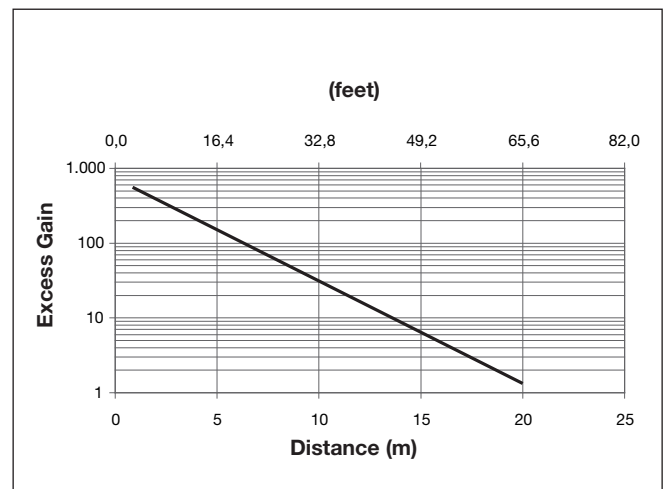

Signal Stability Indication

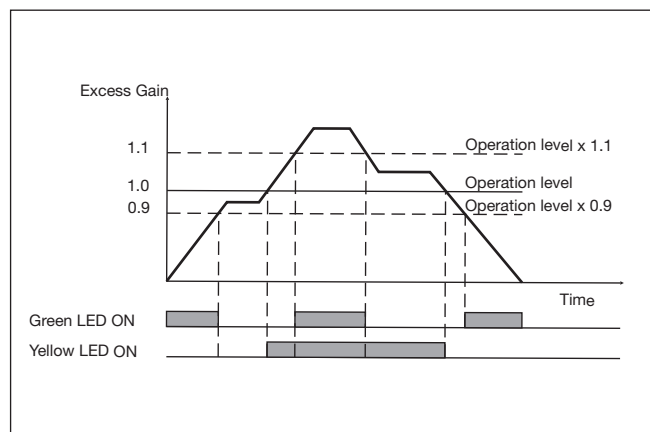

APH18-MB1

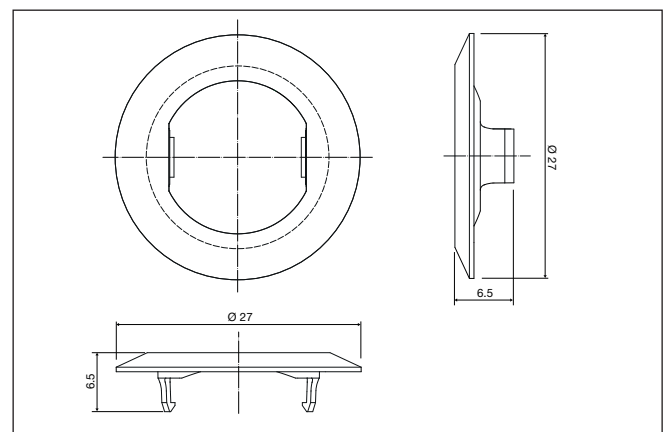

Mounting Systems

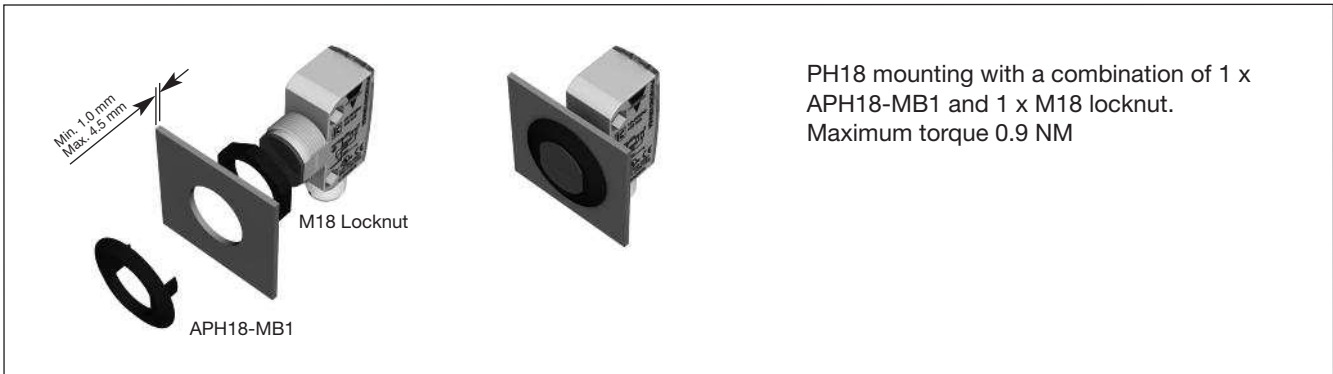

Dimensions

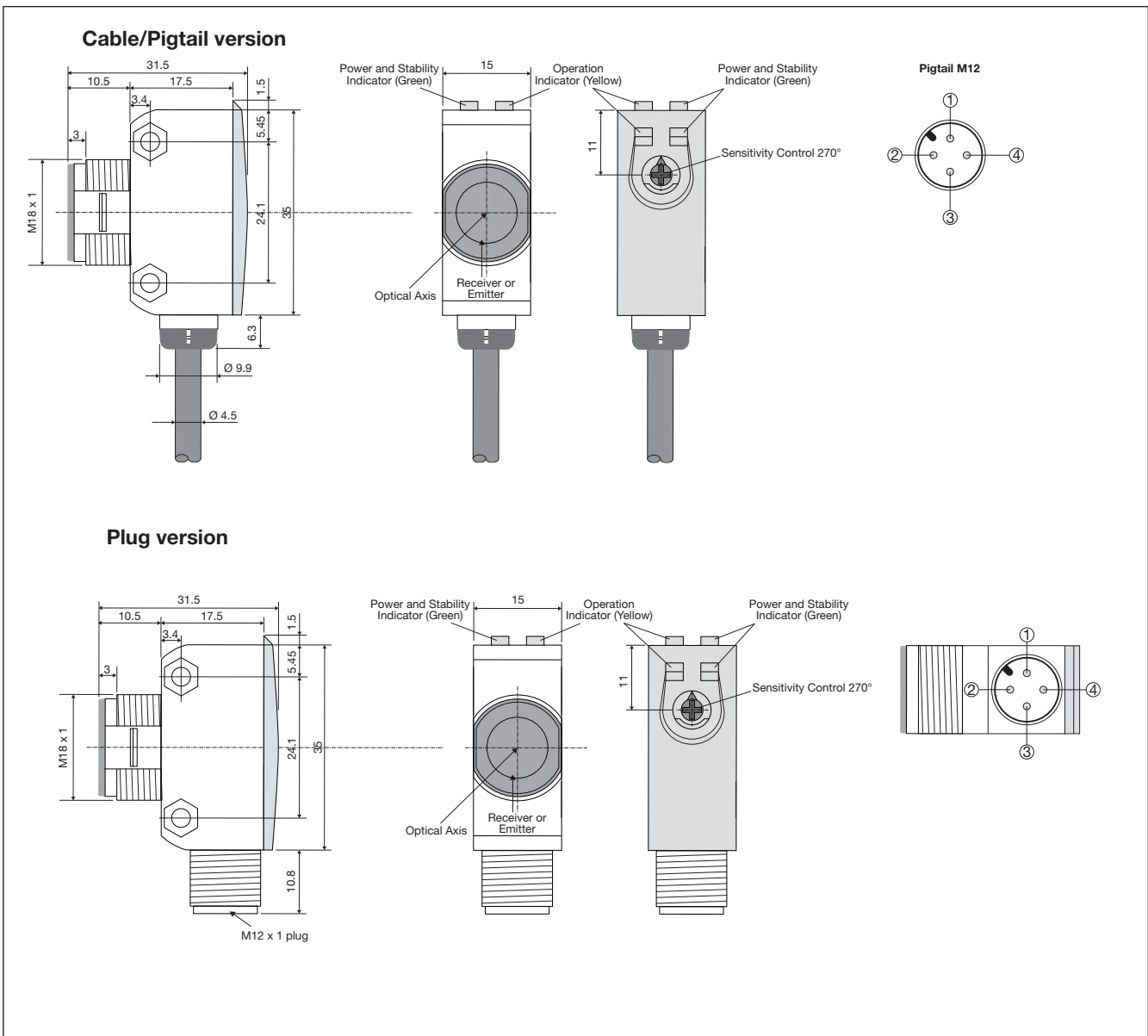

Installation Hints

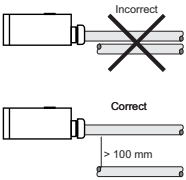
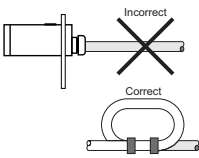
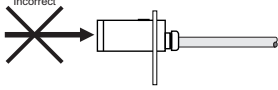
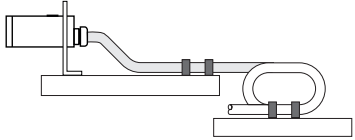
<p>To avoid interference from inductive voltage / current peaks, separate the proximity switch cables from any other power cables. E.g. Engine, contactor or solenoid cables</p> 	<p>Relief of the cable strain</p>  <p>The cable should not be pulled</p>	<p>Protection of the sensing face</p>  <p>A proximity switch should not serve as mechanical stop</p>	<p>Sensor mounted on a mobile carrier</p>  <p>Any repetitive flexing of the cable should be avoided</p>
--	---	--	--

Delivery Contents

- Photoelectric switch: PH 18 CNT...
- Installation instruction on plastic bag
- Screwdriver
- Mounting bracket APH18-MB1
- 1 M18 locknuts
- **Packaging:** Plastic bag
- Emitter and receiver is packed separately

Accessories

- Connector type CONG1A.. / CONM14NF.. series