

Part Number: TBA24-11SURKCGKWA

Hyper Red  
Green

### Features

- 2.4 inch matrix height.
- Dot size 5mm.
- Low current operation.
- High contrast and light output.
- Stackable horizontally.
- Easy mounting on P.C. boards or sockets.
- Multicolor available.
- Mechanically rugged.
- Standard : gray face, white dot.
- RoHS compliant.

### Description

The Hyper Red source color devices are made with Al-GaN on GaAs substrate Light Emitting Diode.  
The Green source color devices are made with AlGaInP on GaAs substrate Light Emitting Diode.

### Package Dimensions & Internal Circuit Diagram

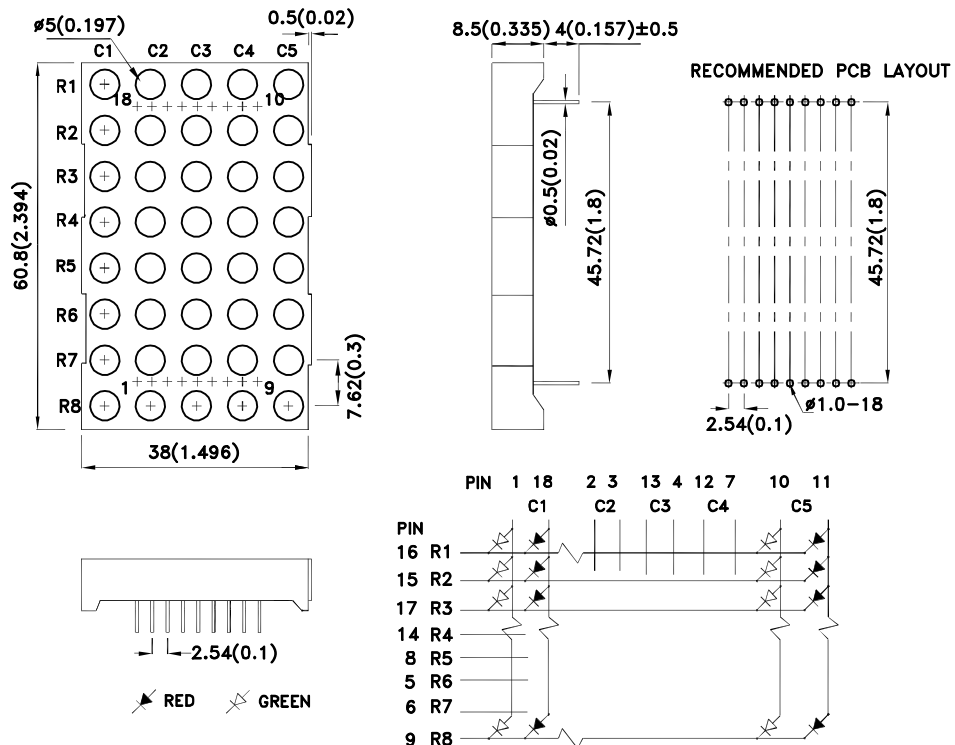

**Notes:**

1. All dimensions are in millimeters (inches), Tolerance is ±0.25(0.01") unless otherwise noted.
2. The specifications, characteristics and technical data described in the datasheet are subject to change without prior notice.



## Selection Guide

Part No.	Dice	Lens Type	Iv (ucd) [1] @ 10mA		Description
			Min.	Typ.	
TBA24-11SURKCGKWA	Hyper Red (AlGaInP)	White Diffused	52000	150000	Column Anode
	Green (AlGaInP)		21000	42000	

Note:

1. Luminous intensity/ luminous Flux: +/-15%.

## Electrical / Optical Characteristics at TA=25°C

Symbol	Parameter	Device	Typ.	Max.	Units	Test Conditions
$\lambda_{peak}$	Peak Wavelength	Hyper Red Green	650 574		nm	I <sub>F</sub> =20mA
$\lambda_D$ [1]	Dominant Wavelength	Hyper Red Green	630 570		nm	I <sub>F</sub> =20mA
$\Delta\lambda_{1/2}$	Spectral Line Half-width	Hyper Red Green	28 20		nm	I <sub>F</sub> =20mA
C	Capacitance	Hyper Red Green	35 15		pF	V <sub>F</sub> =0V;f=1MHz
V <sub>F</sub> [2]	Forward Voltage	Hyper Red Green	1.95 2.1	2.5 2.5	V	I <sub>F</sub> =20mA
I <sub>R</sub>	Reverse Current	Hyper Red Green		10	uA	V <sub>R</sub> =5V

Notes:

1. Wavelength: +/-1nm.  
2. Forward Voltage: +/-0.1V.

## Absolute Maximum Ratings at TA=25°C

Parameter	Hyper Red	Green	Units
Power dissipation	75	75	mW
DC Forward Current	30	30	mA
Peak Forward Current [1]	185	150	mA
Reverse Voltage	5		V
Operating/Storage Temperature	-40°C To +85°C		
Lead Solder Temperature [2]	260°C For 3-5 Seconds		

Notes:

1. 1/10 Duty Cycle, 0.1ms Pulse Width.  
2. 2mm below package base.

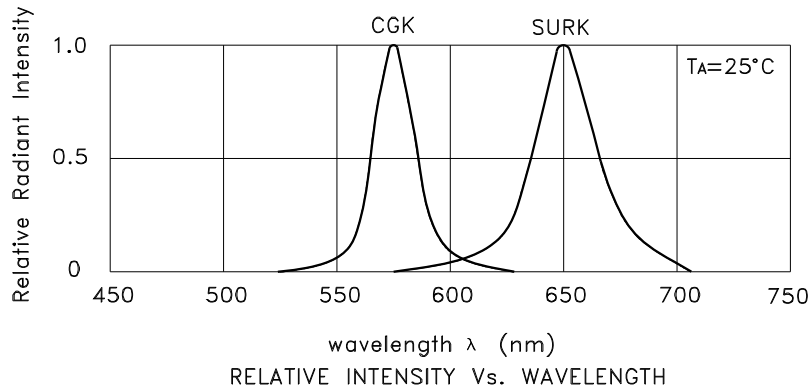

**TBA24-11SURKCGKWA**  
**Hyper Red**

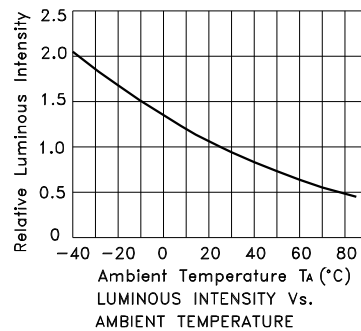
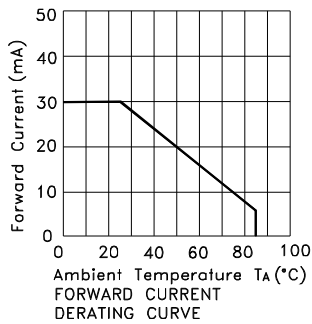
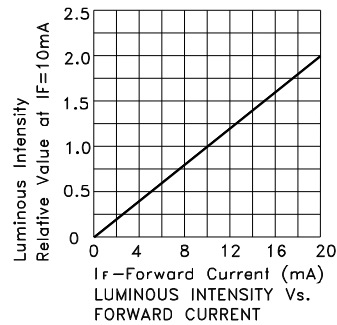
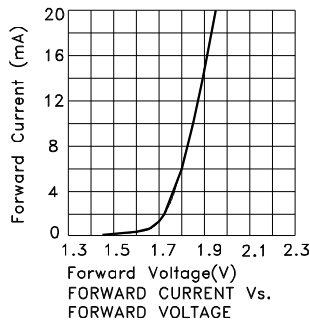

## Green

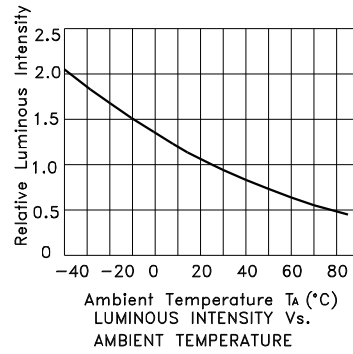
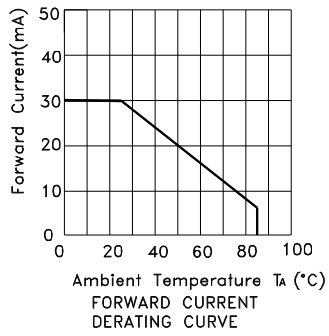
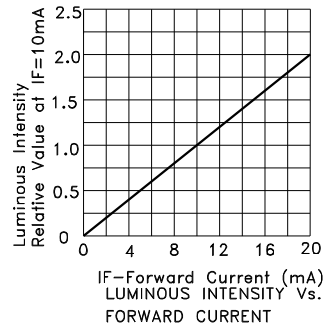
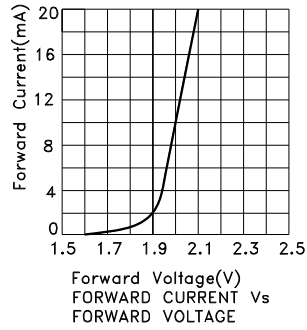

## PACKING & LABEL SPECIFICATIONS

## TBA24-11SURKCGKWA

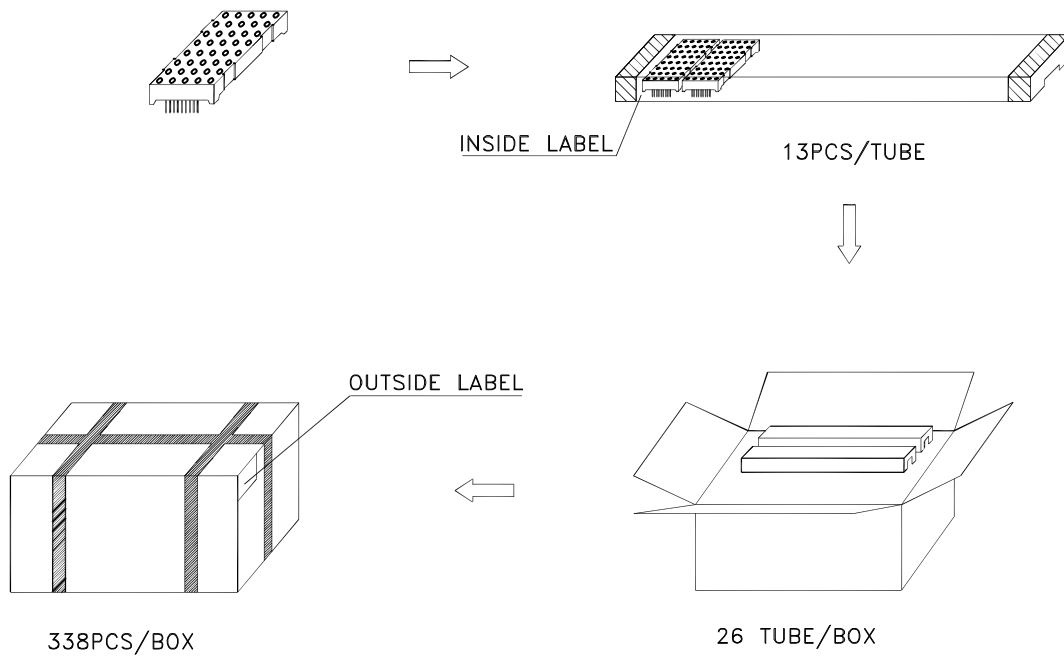

Inside Label On IC-tube

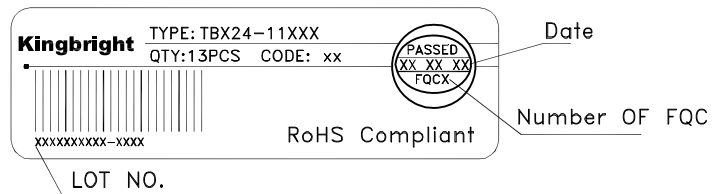

Outside Label On Box

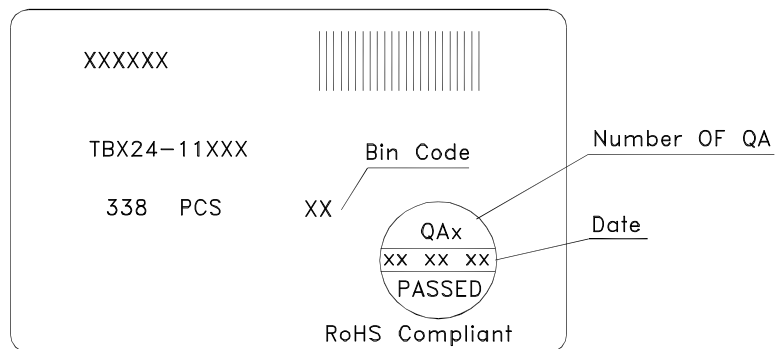

## THROUGH HOLE DISPLAY MOUNTING METHOD

### Lead Forming

Do not bend the component leads by hand without proper tools.  
The leads should be bent by clinching the upper part of the lead firmly such that the bending force is not exerted on the plastic body.

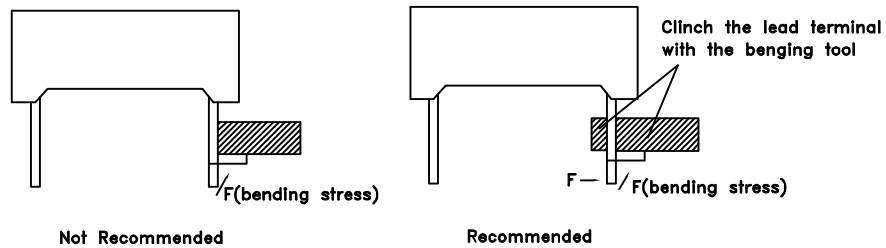

### Installation

- 1.The installation process should not apply stress to the lead terminals.
- 2.When inserting for assembly, ensure the terminal pitch matches the substrate board's hole pitch to prevent spreading or pinching the lead terminals.

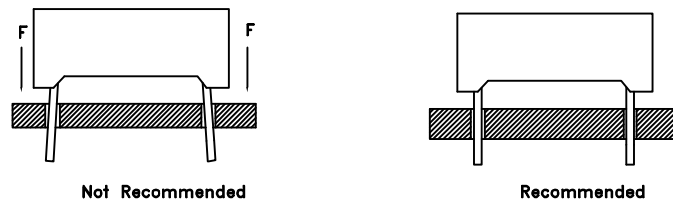

## DISPLAY SOLDERING CONDITIONS

Wave Soldering Profile For Lead-free Through-hole LED.

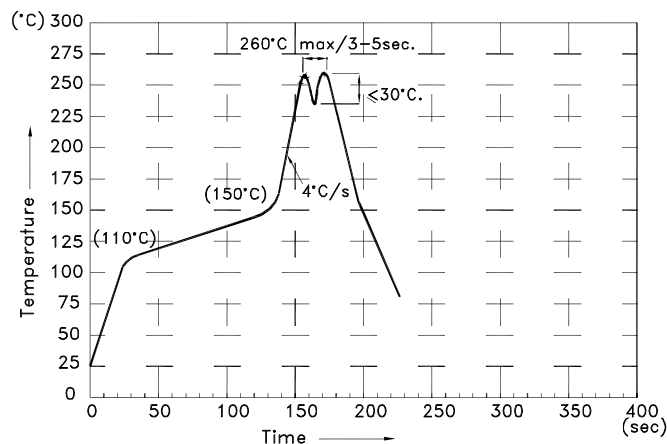

#### NOTES:

- 1.Recommend the wave temperature 245°C~260°C.The maximum soldering temperature should be less than 260°C.
- 2.Do not apply stress on epoxy resins when temperature is over 85°C.
- 3.The soldering profile apply to the lead free soldering (Sn/Cu/Ag alloy).
- 4.During wave soldering , the PCB top-surface temperature should be kept below 105°C
- 5.No more than once.

## Soldering General Notes:

- a. Through-hole displays are incompatible with reflow soldering.
- b. If components will undergo multiple soldering processes, or other processes where the components may be subjected to intense heat, please check with Kingbright for compatibility.

## CLEANING

1. Mild "no-clean" fluxes are recommended for use in soldering.
2. If cleaning is required, Kingbright recommends to wash components with water only. Do not use harsh organic solvents for cleaning, because they may damage the plastic parts. And the devices should not be washed for more than one minute.

## CIRCUIT DESIGN NOTES

1. Protective current-limiting resistors may be necessary to operate the Displays.
2. LEDs mounted in parallel should each be placed in series with its own current-limiting resistor.

