

THE INFORMATION CONTAINED HEREIN IS CONSIDERED "PROPRIETARY" TO BEL FUSE INC. AND SHALL NOT BE COPIED, REPRODUCED OR DISCLOSED WITHOUT THE WRITTEN APPROVAL OF BEL FUSE INC.

RoHS  
2002/95/EC



LED 2 & 4 POLARITY			LED 1 & 3 POLARITY		
PIN 11	PIN 12	COLOR	PIN 13	PIN 14	COLOR
-	+	YELLOW	-	+	YELLOW
+	-	GREEN	+	-	GREEN

**ELECTRICAL CHARACTERISTICS @ 25°C**

**URNS RATIO**

TP1	1CT : 1CT ±2%
TP2	1CT : 1CT ±2%
TP3	1CT : 1CT ±2%
TP4	1CT : 1CT ±2%

**QCL @ 100kHz/100mVRMS**

8mA DC BIAS 350µH MIN.

**INS. LOSS**

0.1MHz TO 1MHz	-1.1 dB MAX
1MHz TO 65MHz	-0.5 dB MAX
65MHz TO 100MHz	-0.8 dB MAX
100MHz TO 125MHz	-1.2 dB MAX

**RET. LOSS (MIN)**

0.5MHz-40MHz	-18 dB
40MHz-100MHz	-12+20LOG(f/80MHz) dB

**CM TO CM REJ**

100kHz - 100MHz -30 dB MIN

**CM TO DM REJ**

100kHz - 100MHz -35 dB MIN

**HIPOT (Isolation Voltage):**

1500 Vrms

100% OF PRODUCTION TESTED TO COMPLY WITH IEEE 802.3 ISOLATION REQUIREMENTS.

**LEDS 1, 2, 3 AND 4**

VF (FORWARD VOLTAGE)	IF=20mA	GREEN	2.2V TYP.
	IF=20mA	YELLOW	2.1V TYP.
λD (DOMINANT WAVELENGTH)	IF=20mA	GREEN	565nm TYP.
	IF=20mA	YELLOW	590nm TYP.

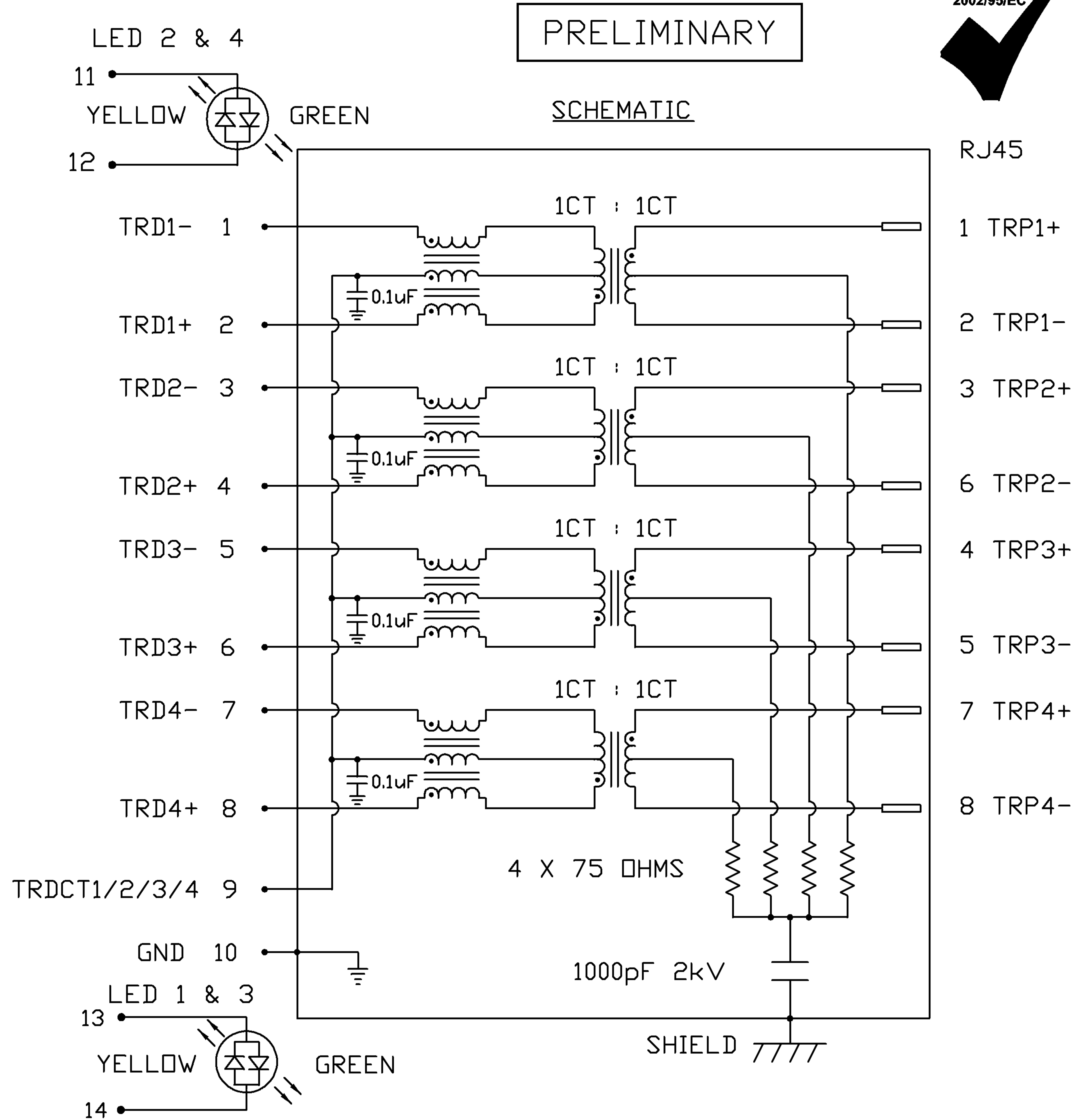

ORIGINATED BY	DATE	TITLE	PART NO. / DRAWING NO.	STANDARD DIM. TOL. IN INCH	[ ] METRIC DIM. AS REFERENCE
CHOW WANCHUNG	11-21-08	2X4 gigabit MagJack® WITH UPPER AND LOWER LED (8 Cores)	0879-2CX4-54	.X	UNIT : INCH [mm] REV. : PA
DRAWN BY	DATE		FILE NAME	.XX	SCALE : N/A SIZE : A4
LEE WEIDE	11-21-08		0879-2CX4-54_PA.DWG	.XXX	PAGE : 2

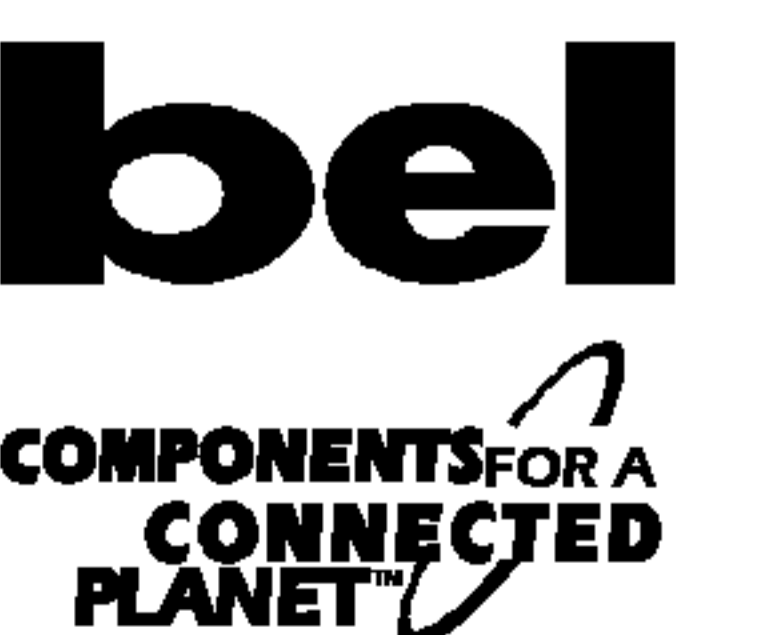

THE INFORMATION CONTAINED HEREIN IS CONSIDERED "PROPRIETARY" TO BEL FUSE INC. AND SHALL NOT BE COPIED, REPRODUCED OR DISCLOSED WITHOUT THE WRITTEN APPROVAL OF BEL FUSE INC.

PRELIMINARY

RoHS  
2002/95/EC

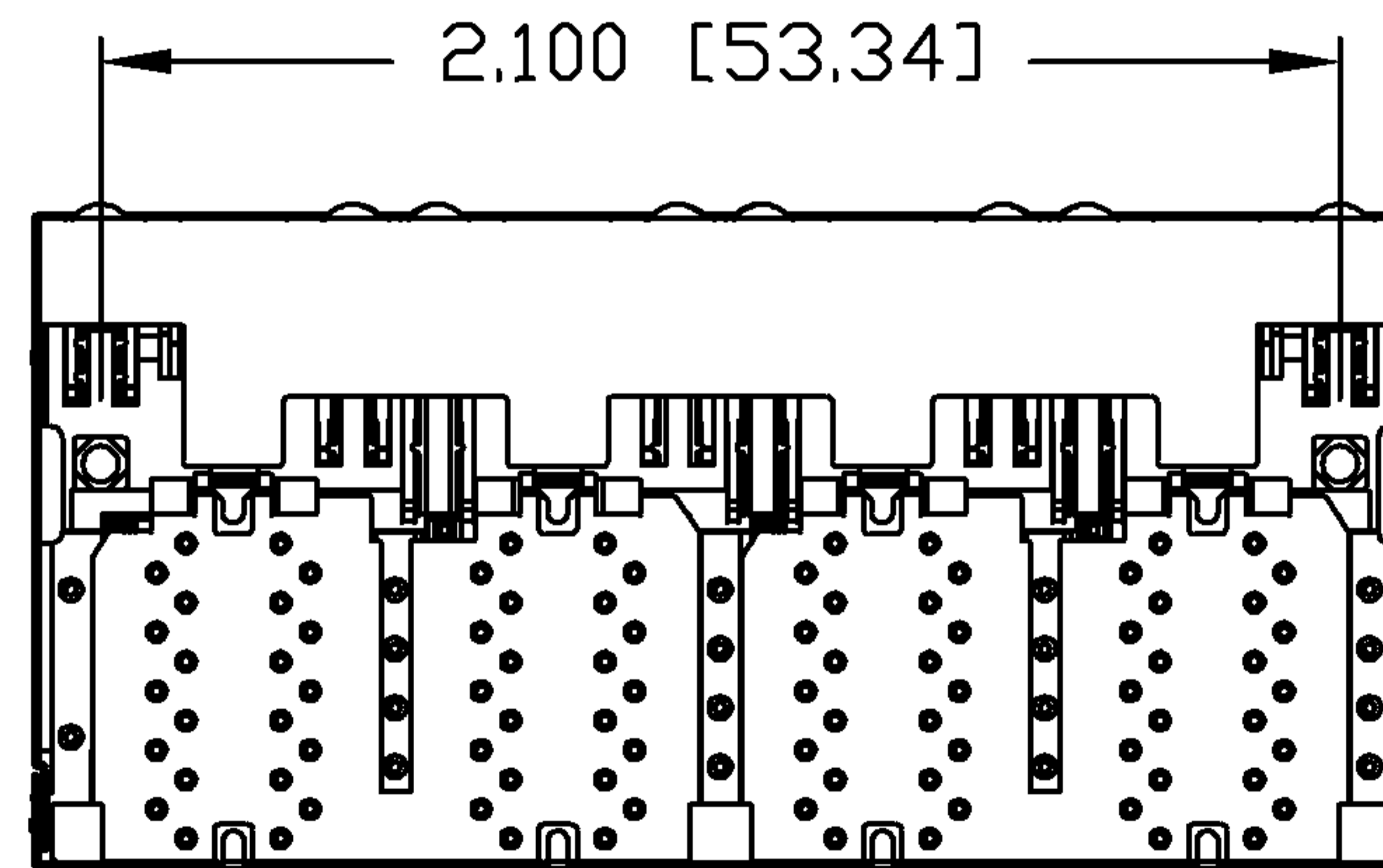
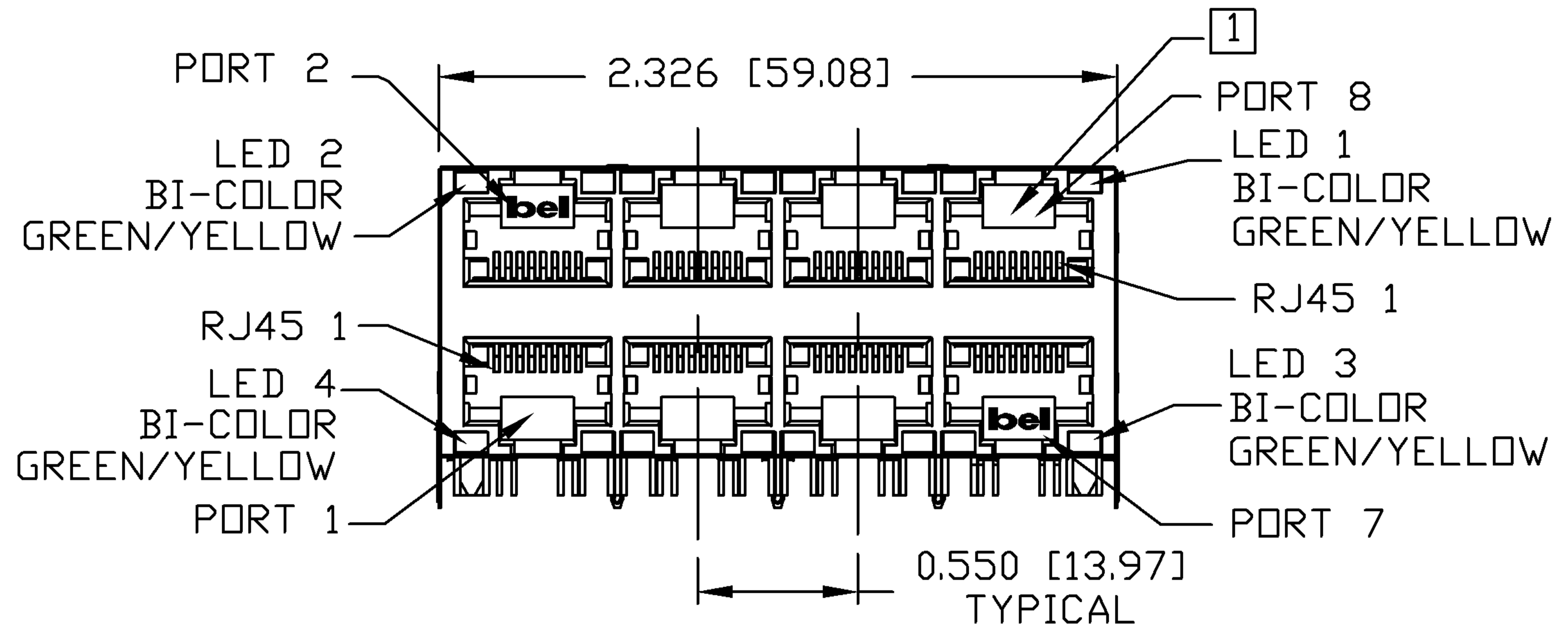
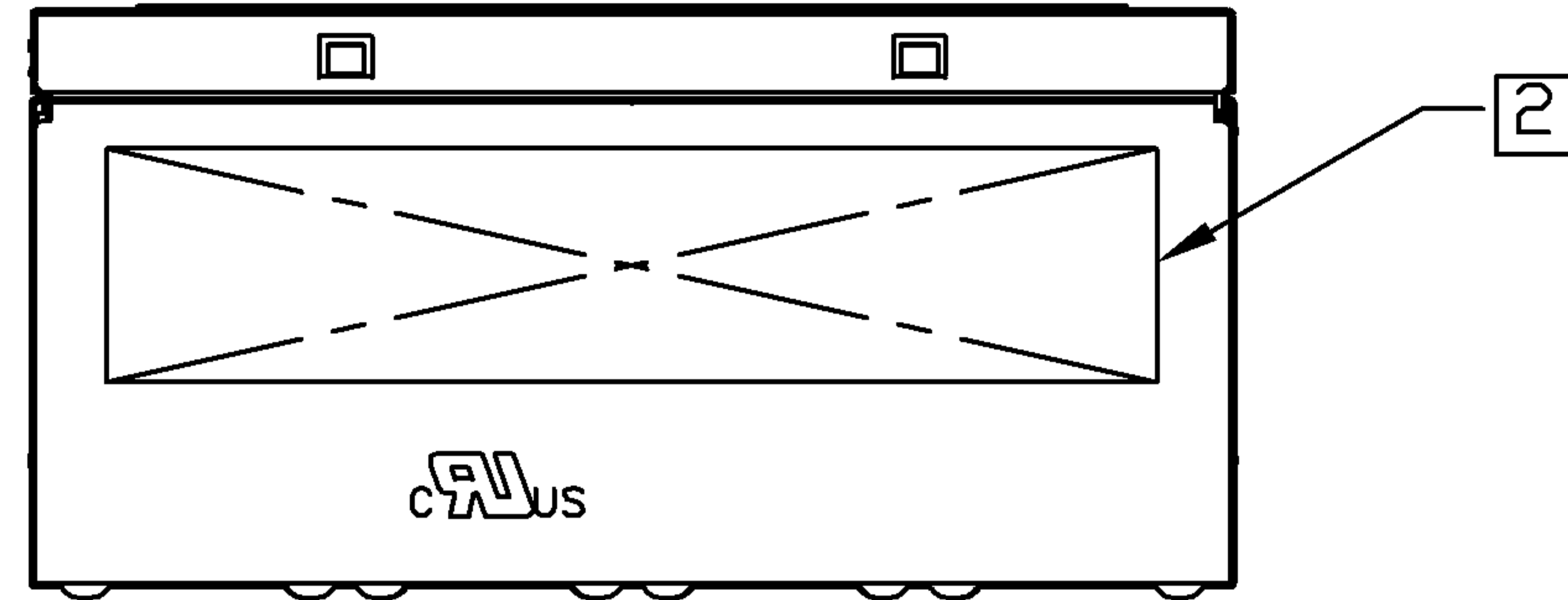
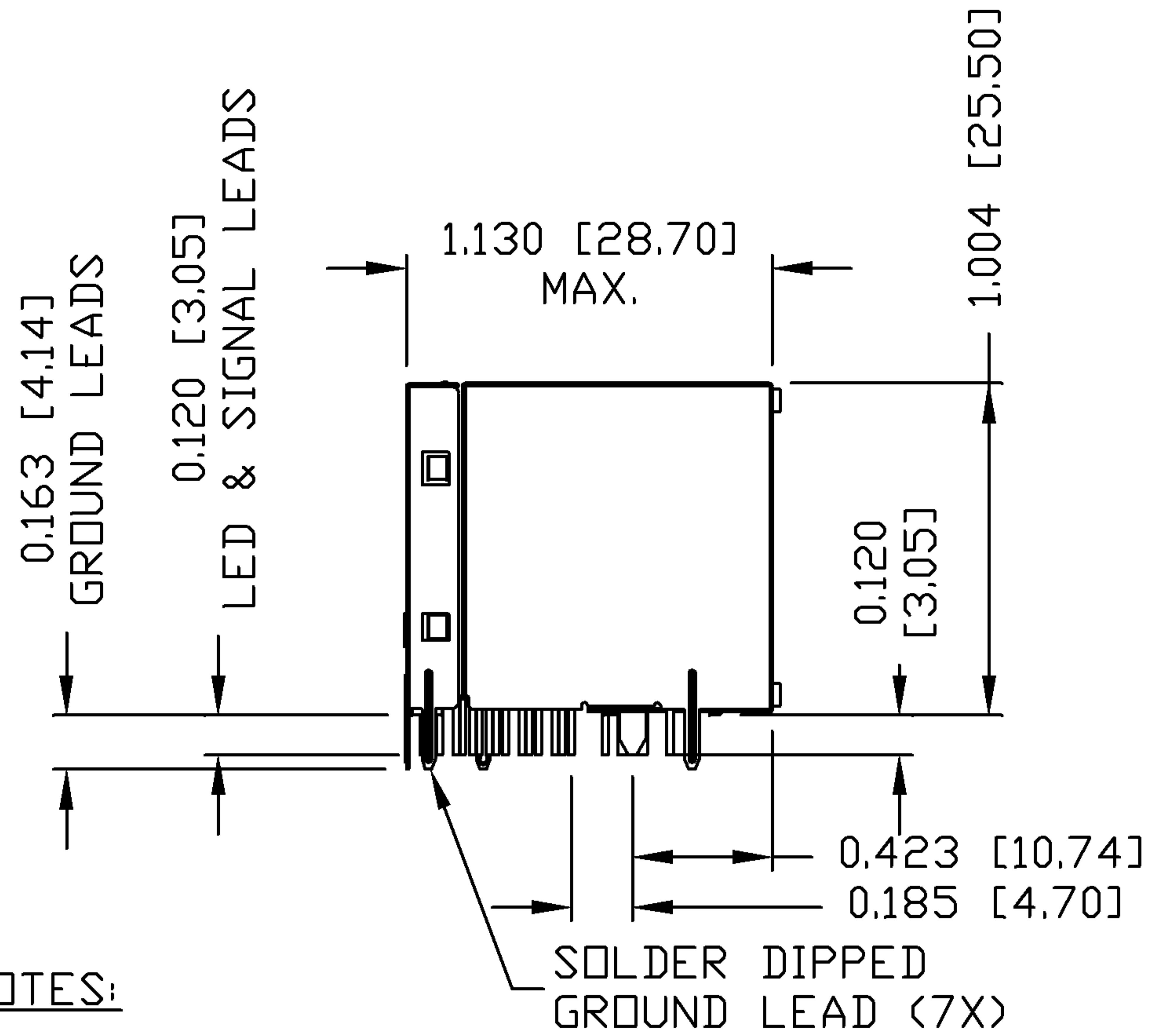
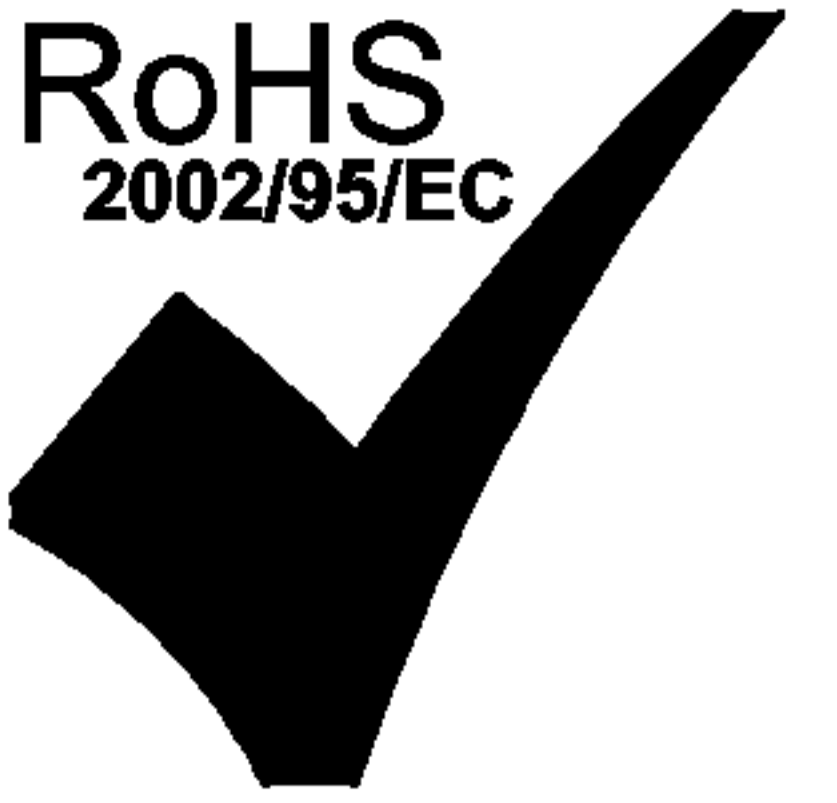

NOTES:

- PLASTIC HOUSING: THERMOPLASTIC PBT  
FLAMMABILITY RATING UL 94V-0
- CONTACT PLATING: 50 MICRO-INCH HARD GOLD PLATING
- OUTPUT PINS: TIN-COATED COPPER WIRE, DIA 0.018 INCH.
- METAL SHIELD: NICKEL PLATED ON COPPER ALLOY.  
(ALL GROUND LEADS ARE SOLDER DIPPED)

- [1] JACK CAVITY CONFORMS TO FCC RULES AND REGULATIONS, PART 68 SUBPART F.
- [2] MARK PART WITH MFG LOGO, MFG NAME, PART NUMBER, AND DATE CODE.

3. RoHS COMPLIANCE, PER EU DIRECTIVE 2002/95/EC.

c USUL RECOGNIZED - FILE #E196366 AND E169987.

ORIGINATED BY	DATE	TITLE	PART NO. / DRAWING NO.	STANDARD DIM. TOL. IN INCH	[ ] METRIC DIM. AS REFERENCE
LIU QIN	11-21-08	2X4 gigabit MagJack® WITH UPPER AND LOWER LED (8 Cores)	0879-2CX4-54	.X	UNIT : INCH [mm] REV. : PA
DRAWN BY	DATE		FILE NAME	.XX	SCALE : N/A SIZE : A4
XIAN JIAXIN	11-21-08		0879-2CX4-54_PA.DWG	.XXX ±0.010	⊕ - - - PAGE : 3



THE INFORMATION CONTAINED HEREIN IS CONSIDERED "PROPRIETARY" TO BEL FUSE INC. AND SHALL NOT BE COPIED, REPRODUCED OR DISCLOSED WITHOUT THE WRITTEN APPROVAL OF BEL FUSE INC.

RoHS  
2002/95/EC

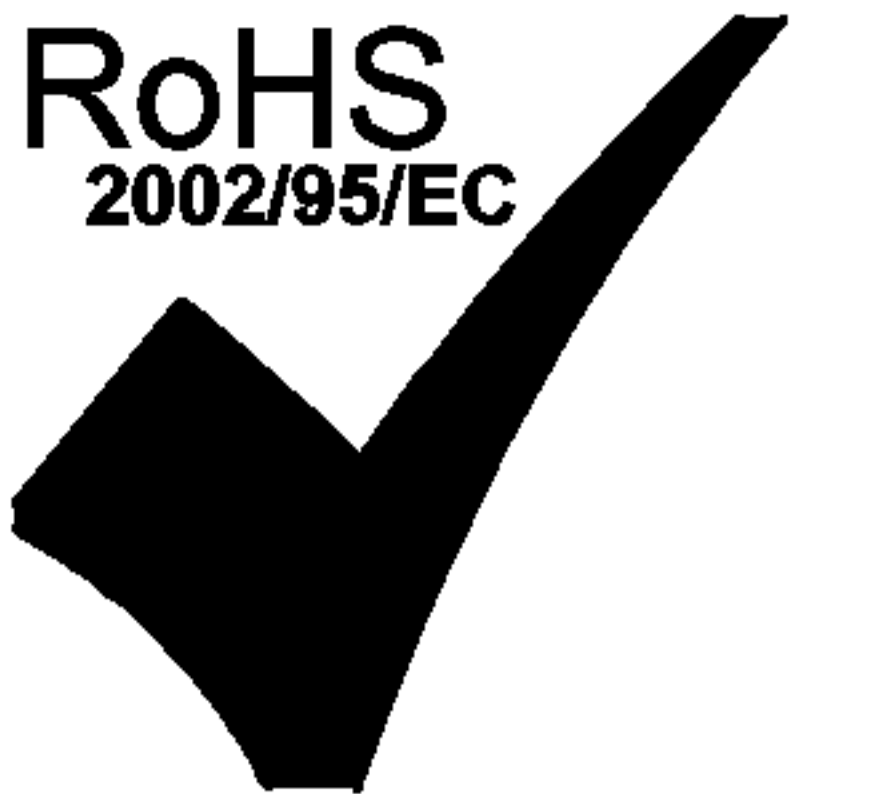

PRELIMINARY

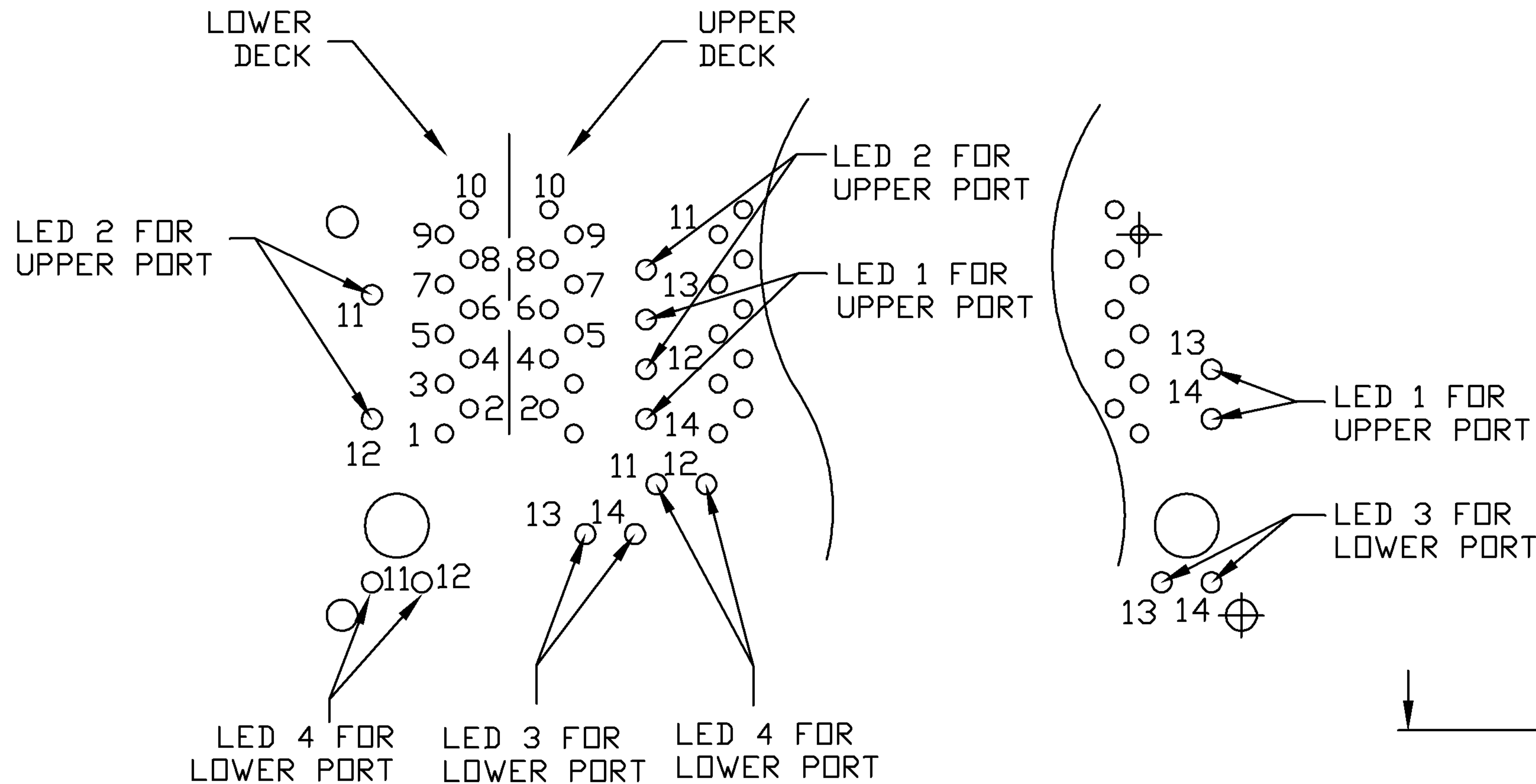

PORT ASSIGNMENT  
(COMPONENT SIDE VIEW)

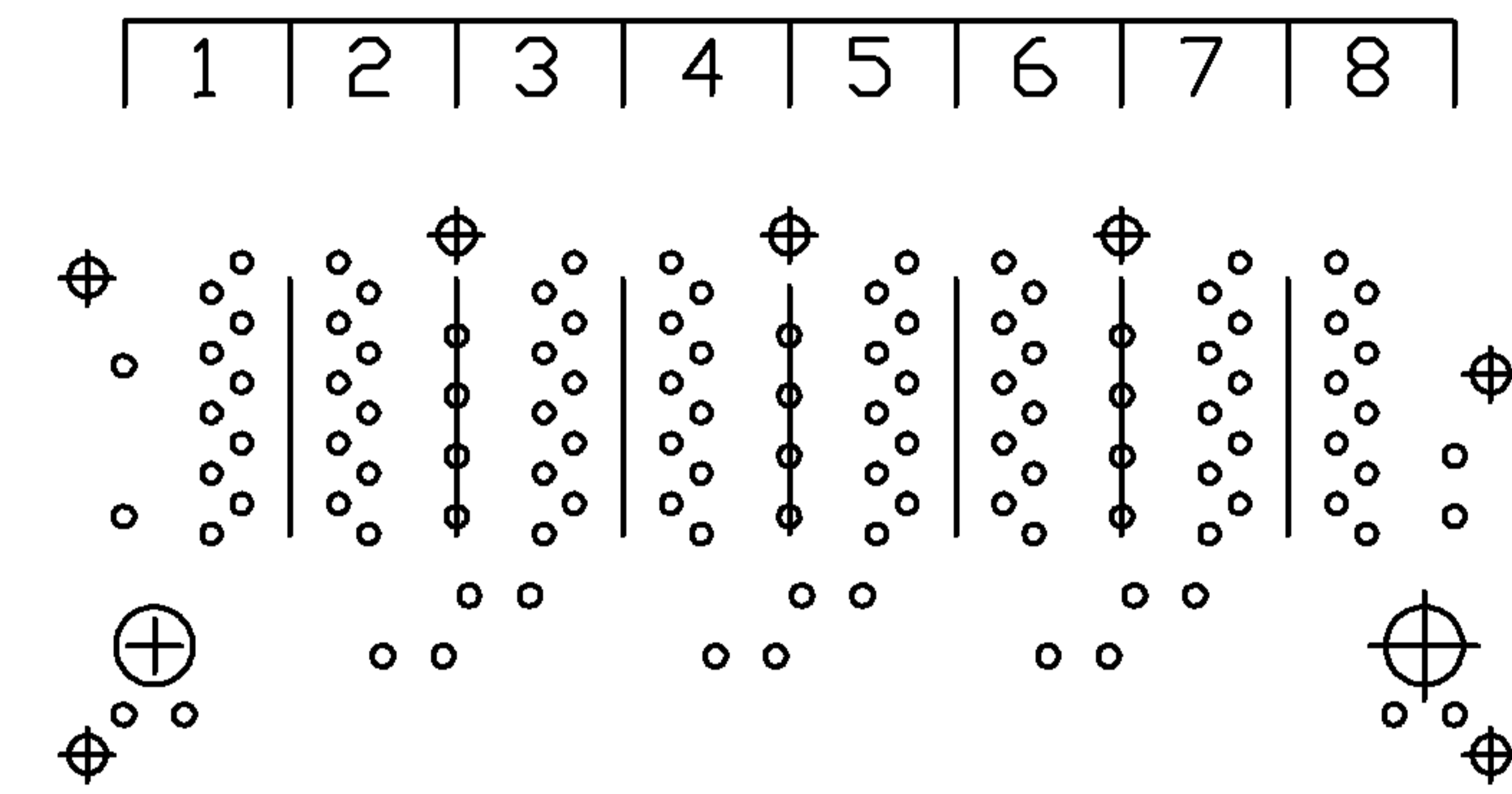

PIN-OUT INFORMATION  
(COMPONENT SIDE VIEW)

10	GND		
9	TRDCT1/2/3/4		
8	TRD 4+		
7	TRD 4-		
6	TRD 3+		
5	TRD 3-		
4	TRD 2+	14	GREEN (-)/YELLOW (+)
3	TRD 2-	13	GREEN (+)/YELLOW (-)
2	TRD 1+	12	GREEN (-)/YELLOW (+)
1	TRD 1-	11	GREEN (+)/YELLOW (-)

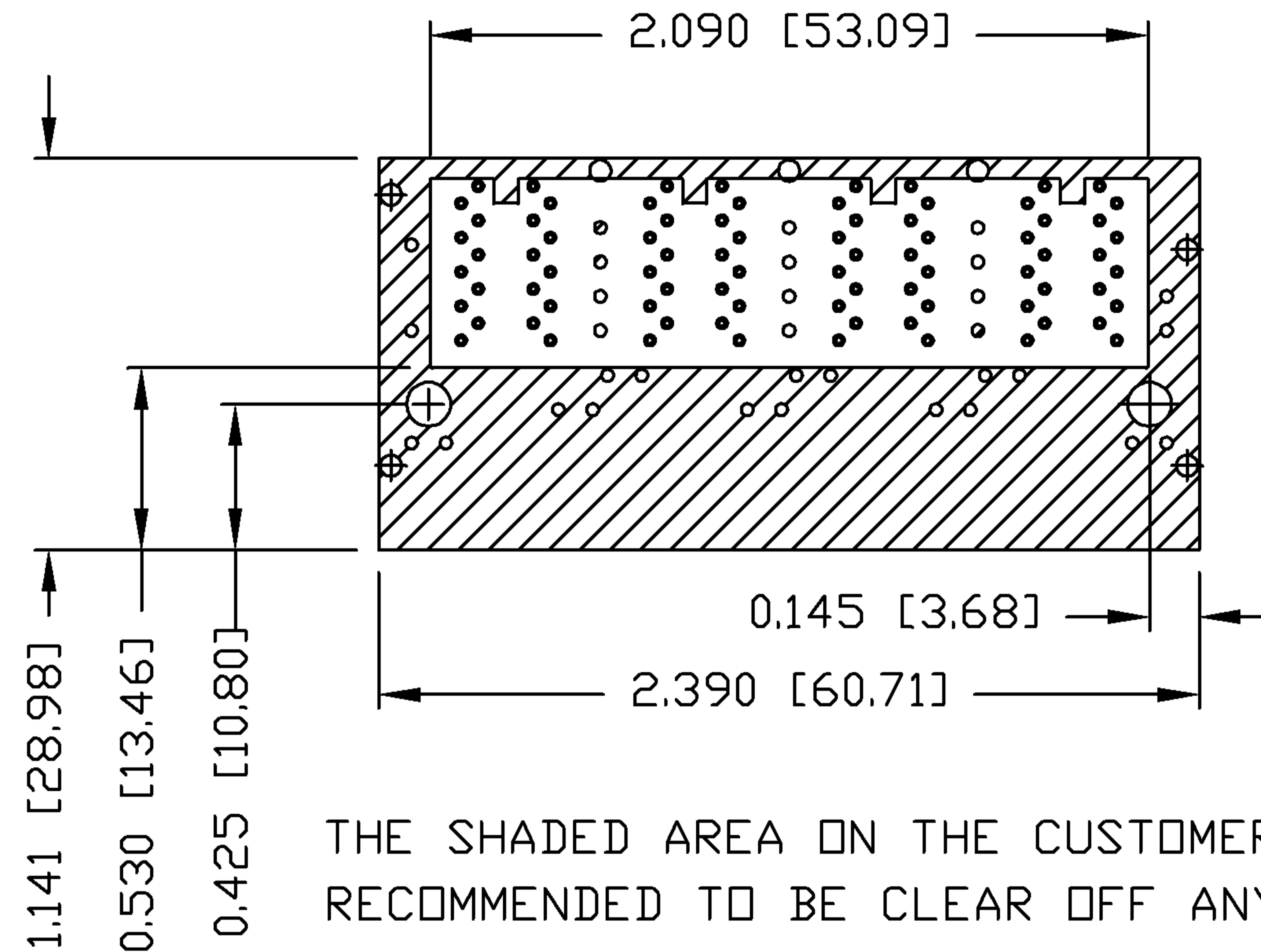

THE SHADED AREA ON THE CUSTOMER BOARD ARE RECOMMENDED TO BE CLEAR OFF ANY VIA HOLE OR COMPONENT PAD.

ORIGINATED BY	DATE	TITLE	PART NO. / DRAWING NO.	STANDARD DIM. TOL. IN INCH	[ ] METRIC DIM. AS REFERENCE
LIU QIN	11-21-08	2X4 gigabit MagJack® WITH UPPER AND LOWER LED (8 Cores)	0879-2CX4-54	.X	UNIT : INCH [mm] REV. : PA
DRAWN BY	DATE		FILE NAME	.XX	SCALE : N/A SIZE : A4
XIAN JIAXIN	11-21-08		0879-2CX4-54_PA.DWG	.XXX	±0.004
					PAGE : 4



THE INFORMATION CONTAINED HEREIN IS CONSIDERED "PROPRIETARY" TO BEL FUSE INC. AND SHALL NOT BE COPIED, REPRODUCED OR DISCLOSED WITHOUT THE WRITTEN APPROVAL OF BEL FUSE INC.

RoHS  
2002/95/EC

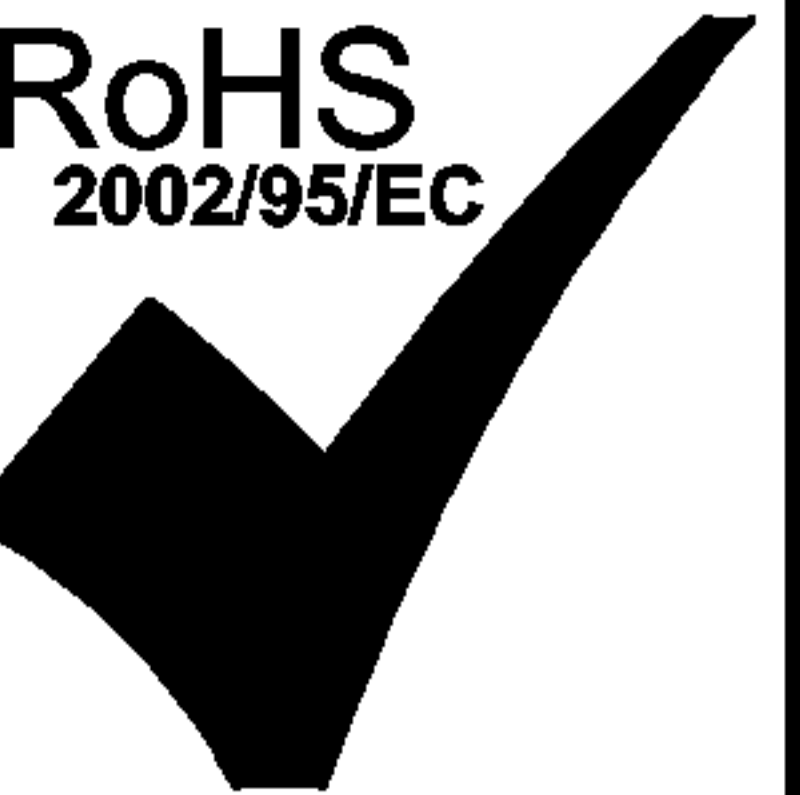

PRELIMINARY



ORIGINATED BY LIU QIN	DATE 11-21-08	TITLE 2X4 gigabit MagJack® WITH UPPER AND LOWER LED (8 Cores)	PART NO. / DRAWING NO. 0879-2CX4-54	STANDARD DIM. TOL. IN INCH .X .XX .XXX ±0.004	[ ] METRIC DIM. AS REFERENCE UNIT : INCH [mm] SCALE : N/A REV. : PA SIZE : A4 PAGE : 5	 COMPONENTS FOR A CONNECTED PLANET
DRAWN BY XIAN JIAXIN	DATE 11-21-08		FILE NAME 0879-2CX4-54_PA.DWG			

THE INFORMATION CONTAINED HEREIN IS CONSIDERED "PROPRIETARY" TO BEL FUSE INC. AND SHALL NOT BE COPIED, REPRODUCED OR DISCLOSED WITHOUT THE WRITTEN APPROVAL OF BEL FUSE INC.

PRELIMINARY

RoHS  
2002/95/EC

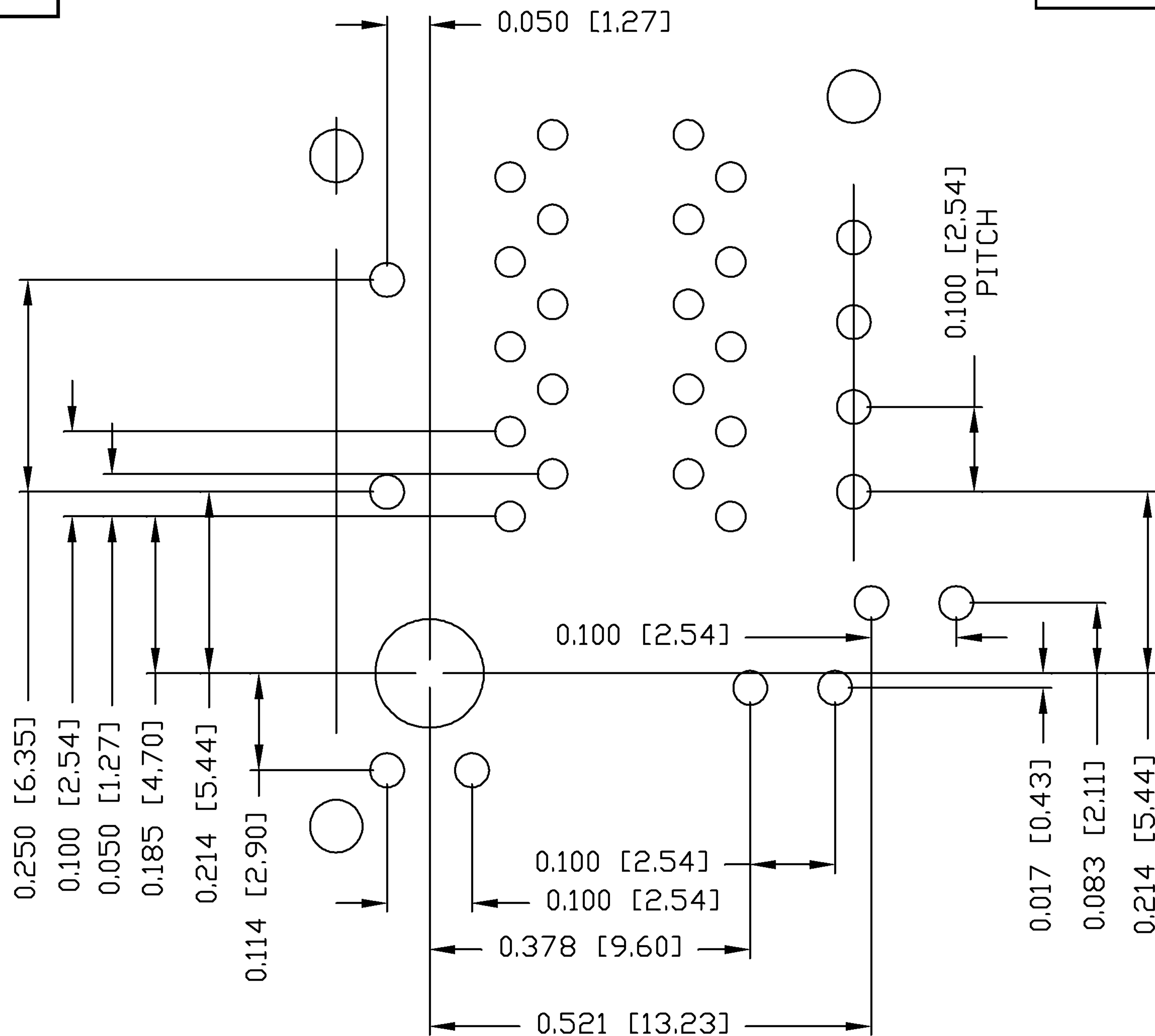
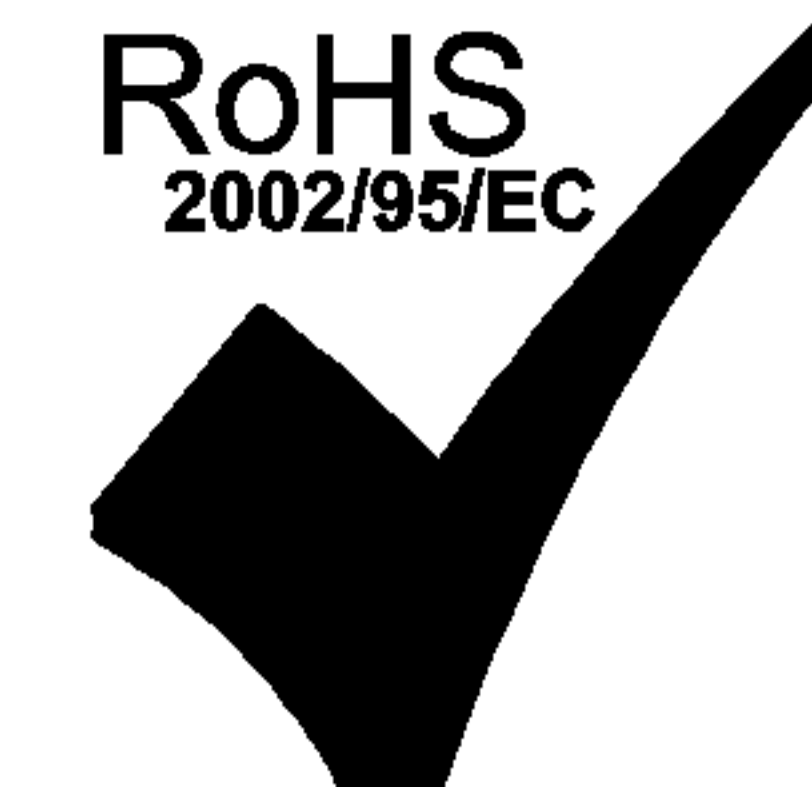

DETAIL A

ORIGINATED BY	DATE	TITLE 2X4 gigabit MagJack® WITH UPPER AND LOWER LED (8 Cores)	PART NO. / DRAWING NO.	STANDARD DIM.	[ ] METRIC DIM. AS REFERENCE	
LIU QIN	11-21-08		0879-2CX4-54	TOL. IN INCH	UNIT : INCH [mm]	REV. : PA
DRAWN BY	DATE		FILE NAME	.X	SCALE : N/A	SIZE : A4
XIAN JIAXIN	11-21-08		0879-2CX4-54_PA.DWG	.XX	±0.004	PAGE : 6
				.XXX		



THE INFORMATION CONTAINED HEREIN IS CONSIDERED "PROPRIETARY" TO BEL FUSE INC. AND SHALL NOT BE COPIED, REPRODUCED OR DISCLOSED WITHOUT THE WRITTEN APPROVAL OF BEL FUSE INC.

RoHS  
2002/95/EC

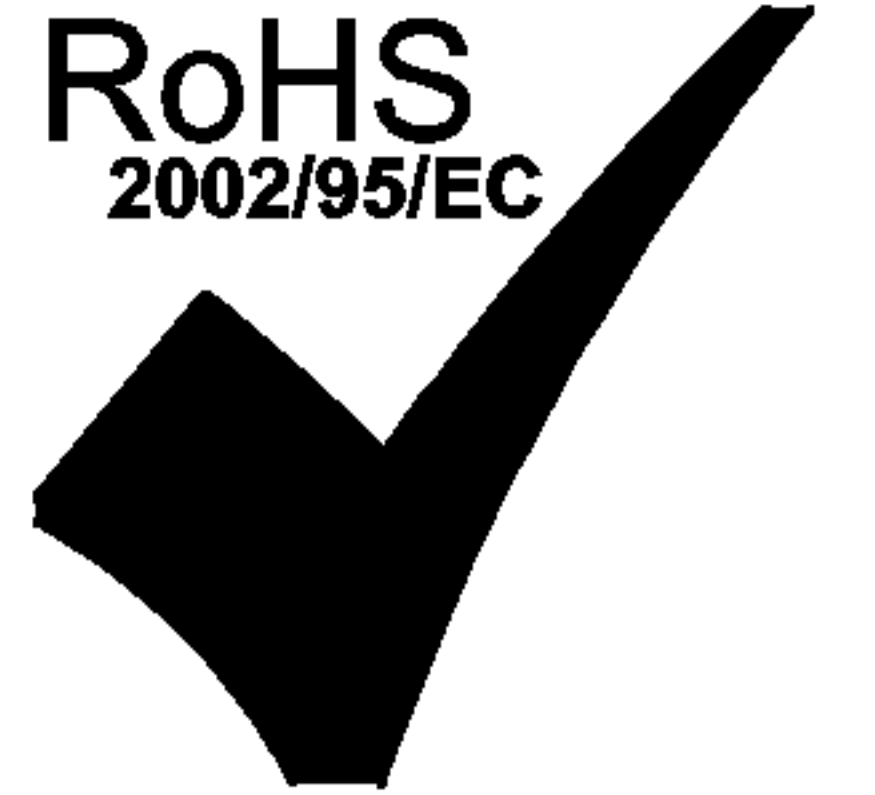

PRELIMINARY

SUGGESTED PANEL OPENING

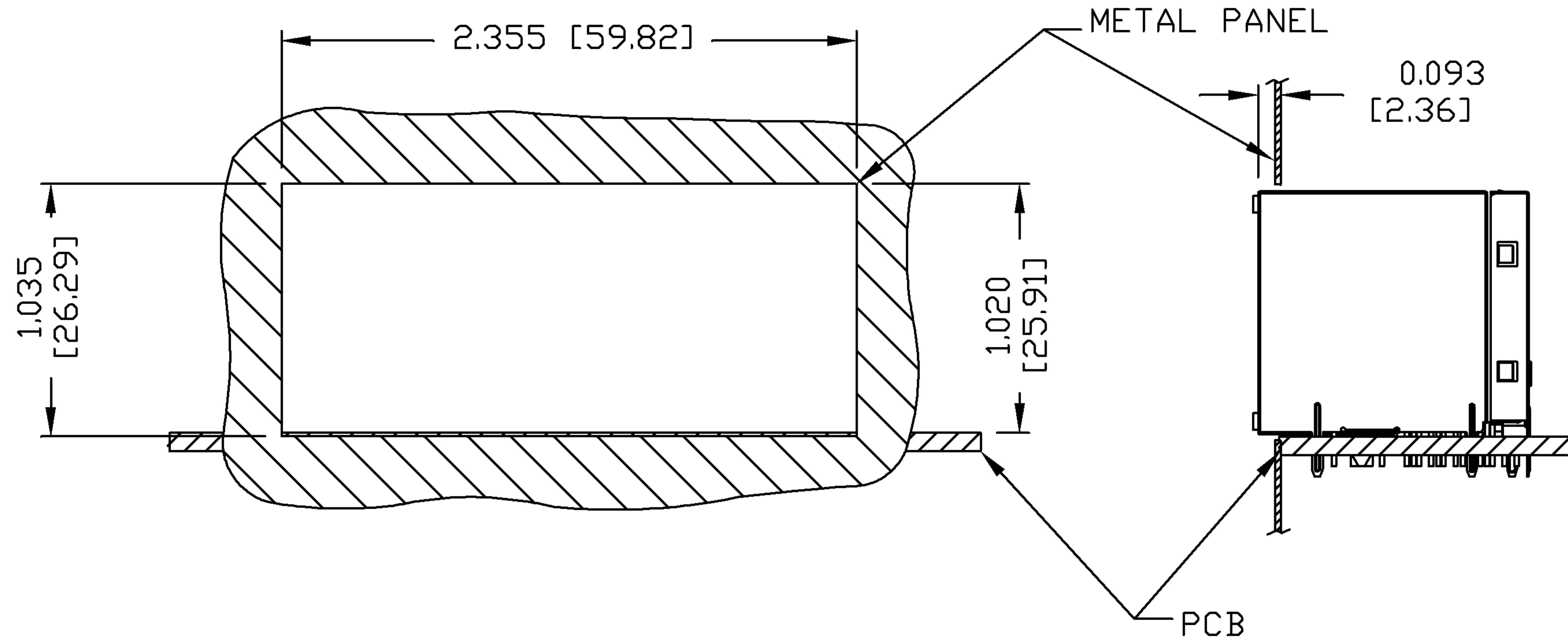

NOTE:

THE DISTANCE OF PANEL INSIDE SURFACE RELATIVE TO FRONT SURFACE OF PART IS ONLY A SUGGESTION. IN CASE THIS DISTANCE IS DIFFERENT, THE REQUIRED PANEL OPENING DIMENSIONS CHANGE ACCORDINGLY.

PACKING INFORMATION

PACKING TRAY : 0200-9999-Q1 (TOP)  
0200-9999-Q2 (BOTTOM)

PACKING QUANTITY : 20 PCS FINISHED GOODS PER TRAY  
7 TRAYS (140 PCS FINISHED GOODS) PER CARTON BOX

NOTE : CARDBOARDS ARE PLACED BETWEEN LAYERS OF PACKING TRAY INSIDE CARTON BOX  
(INCLUDE THE UPPERMOST AND LOWERMOST TRAY)

ORIGINATED BY	DATE	TITLE	PART NO. / DRAWING NO.	STANDARD DIM. TOL. IN INCH	[ ] METRIC DIM. AS REFERENCE
LIU QIN	11-21-08	2X4 gigabit MagJack® WITH UPPER AND LOWER LED (8 Cores)	0879-2CX4-54	.X	UNIT : INCH [mm] REV. : PA
DRAWN BY	DATE		FILE NAME	.XX	SCALE : N/A SIZE : A4
XIAN JIAXIN	11-21-08		0879-2CX4-54_PA.DWG	.XXX ±0.004	⊕ - - - PAGE : 7

