

Part Number: TC12-22SYKWA

Super Bright Yellow

### Features

- 1.2 inch matrix height .
- Dot size 3mm.
- Low current operation.
- High contrast and light output.
- Easy mounting on P.C. boards or sockets.
- Mechanically rugged.
- Standard:gray face, white dot.
- RoHS compliant.

### Description

The Super Bright Yellow device is made with AlGaInP (on GaAs substrate) light emitting diode chip.

### Package Dimensions& Internal Circuit Diagram

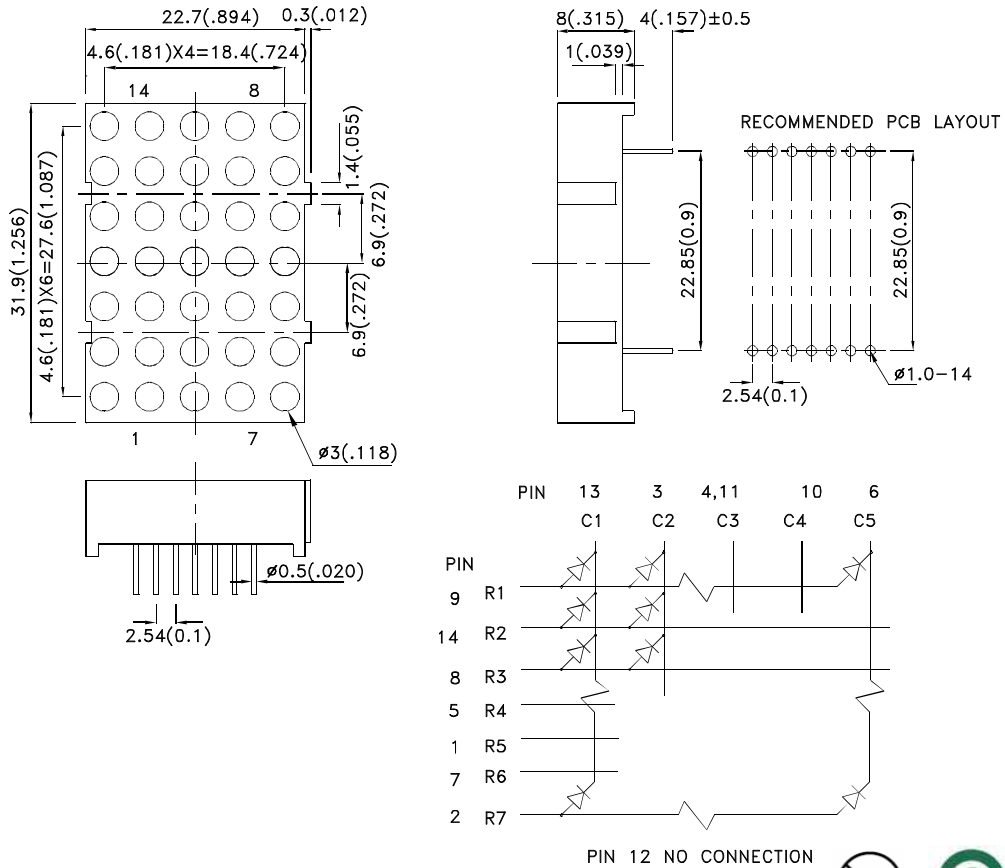

**Notes:**

1. All dimensions are in millimeters (inches), Tolerance is  $\pm 0.25(0.01)$  unless otherwise noted.
2. The specifications, characteristics and technical data described in the datasheet are subject to change without prior notice.

## Selection Guide

Part No.	Dice	Lens Type	Iv (ucd) [1] @ 10mA		Description
			Min.	Typ.	
TC12-22SYKWA	Super Bright Yellow (AlGaInP)	WHITE DIFFUSED	18000	86500	Column Cathode

Note:

1. Luminous intensity/ luminous Flux: +/-15%.

## Electrical / Optical Characteristics at TA=25°C

Symbol	Parameter	Device	Typ.	Max.	Units	Test Conditions
$\lambda_{peak}$	Peak Wavelength	Super Bright Yellow	590		nm	I <sub>F</sub> =20mA
$\lambda_D$ [1]	Dominant Wavelength	Super Bright Yellow	590		nm	I <sub>F</sub> =20mA
$\Delta\lambda_{1/2}$	Spectral Line Half-width	Super Bright Yellow	20		nm	I <sub>F</sub> =20mA
C	Capacitance	Super Bright Yellow	20		pF	V <sub>F</sub> =0V;f=1MHz
V <sub>F</sub> [2]	Forward Voltage	Super Bright Yellow	2.0	2.5	V	I <sub>F</sub> =20mA
I <sub>R</sub>	Reverse Current	Super Bright Yellow		10	uA	V <sub>R</sub> =5V

Notes:

1. Wavelength: +/-1nm.  
2. Forward Voltage: +/-0.1V.

## Absolute Maximum Ratings at TA=25°C

Parameter	Super Bright Yellow	Units
Power dissipation	75	mW
DC Forward Current	30	mA
Peak Forward Current [1]	175	mA
Reverse Voltage	5	V
Operating / Storage Temperature	-40°C To +85°C	
Lead Solder Temperature[2]	260°C For 3-5 Seconds	

Notes:

1. 1/10 Duty Cycle, 0.1ms Pulse Width.  
2. 2mm below package base.



## Super Bright Yellow TC12-22SYKWA

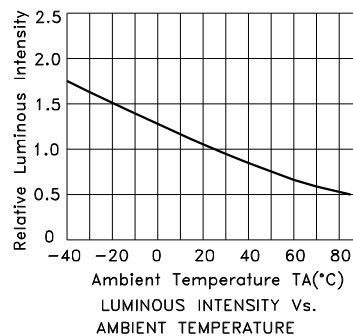
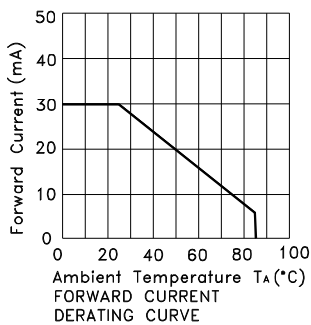
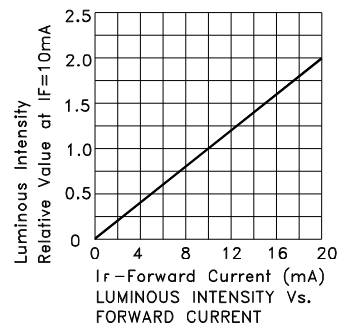
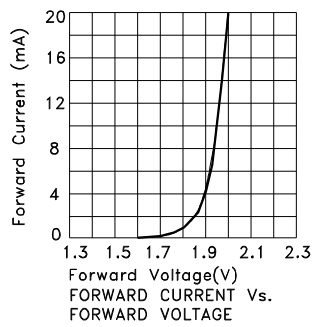

**PACKING & LABEL SPECIFICATIONS**

**TC12-22SYKWA**

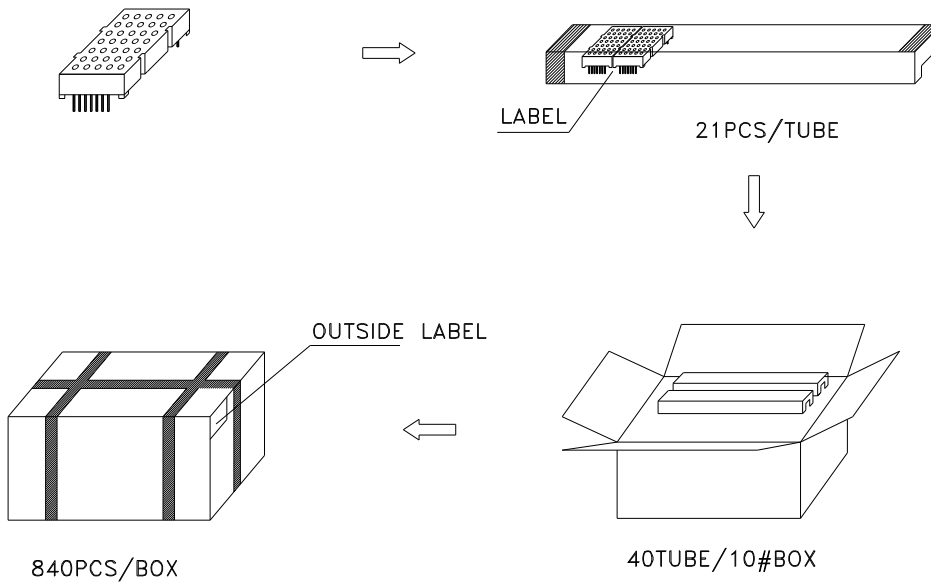

Inside Label Paste On The IC-tube

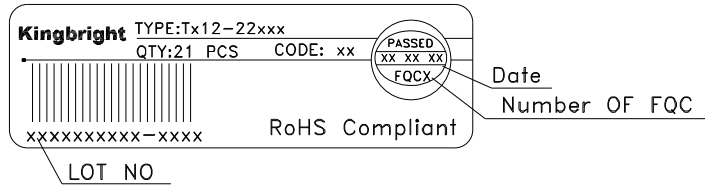

Outside Label Paste On The Box

