

Part Number: KP-2012SF4C

Features

- 2.0mmx1.25mm SMT LED, 1.1mm thickness.
- Mechanically and spectrally matched to the phototransistor.
- Package: 2000pcs / reel.
- Moisture sensitivity level : level 3.
- RoHS compliant.

Description

SF4 Made with Gallium Aluminum Arsenide Infrared Emitting diodes.

Package Dimensions

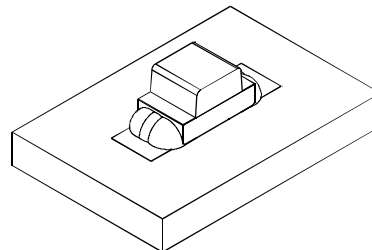
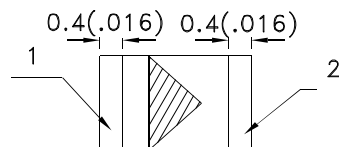
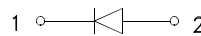
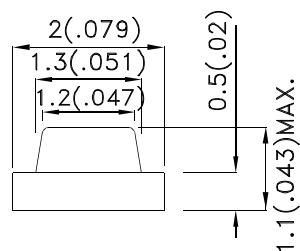
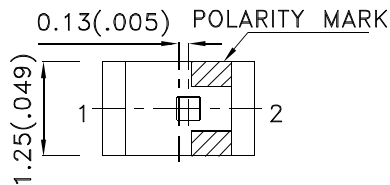

Notes:

1. All dimensions are in millimeters (inches).
2. Tolerance is ± 0.1 (0.004") unless otherwise noted.
3. The specifications, characteristics and technical data described in the datasheet are subject to change without prior notice.
4. The device has a single mounting surface. The device must be mounted according to the specifications.



Selection Guide

Part No.	Dice	Lens Type	Po (mW/sr) [2] @ 20mA		Viewing Angle [1]
			Min.	Typ.	2θ1/2
KP-2012SF4C	SF4 (GaAlAs)	Water Clear	0.8	1.5	120°

Notes:

1. θ1/2 is the angle from optical centerline where the luminous intensity is 1/2 of the optical peak value.
2. Radiant Intensity/ luminous flux: +/-15%.

Electrical / Optical Characteristics at TA=25°C

Parameter	P/N	Symbol	Typ.	Max.	Units	Test Conditions
Forward Voltage [1]	SF4	V _F	1.3	1.6	V	I _F =20mA
Reverse Current	SF4	I _R		10	μA	V _R = 5V
Capacitance	SF4	C	90		pF	V _F =0V;f=1MHz
Peak Spectral Wavelength	SF4	λ _P	880		nm	I _F =20mA
Spectral Bandwidth	SF4	Δλ1/2	50		nm	I _F =20mA

Note:

1. Forward Voltage: +/-0.1V.

Absolute Maximum Ratings at TA=25°C

Parameter	Symbol	SF4	Units
Power dissipation	P _D	80	mW
DC Forward Current	I _F	50	mA
Peak Forward Current [1]	i _{FS}	1.2	A
Reverse Voltage	V _R	5	V
Operating Temperature	T _A	-40 To +85	°C
Storage Temperature	T _{STG}	-40 To +85	°C

Note:

1. 1/100 Duty Cycle, 10μs Pulse Width.

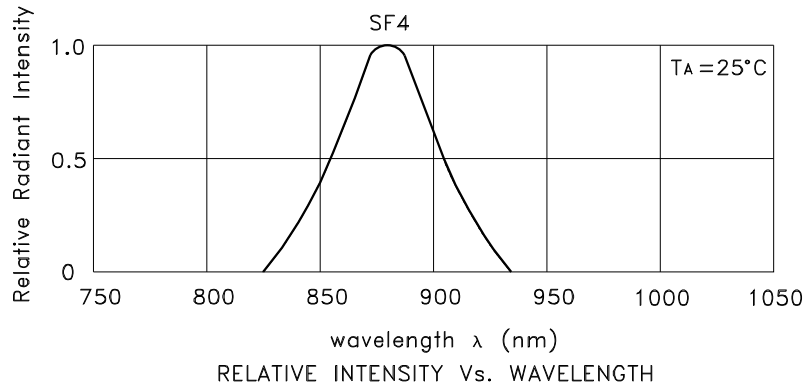

KP-2012SF4C

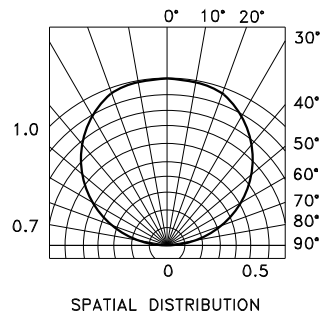
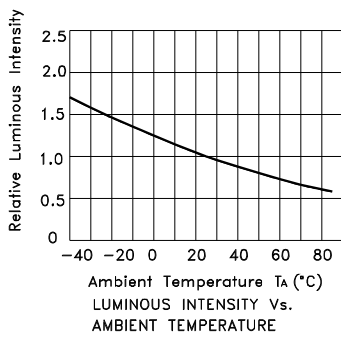
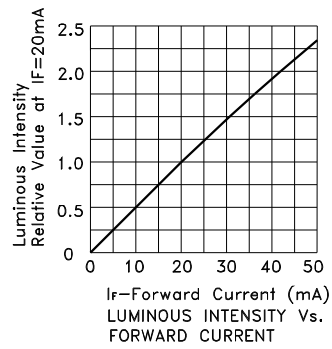
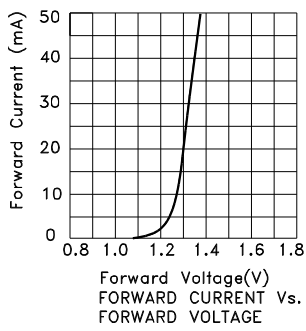

KP-2012SF4C

Reflow soldering is recommended and the soldering profile is shown below.
Other soldering methods are not recommended as they might cause damage to the product.

Reflow Soldering Profile For Lead-free SMT Process.

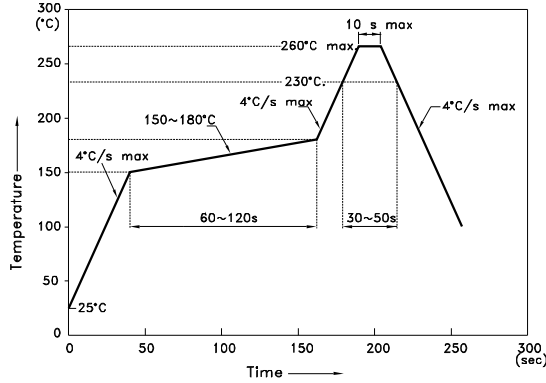

NOTES:

1. We recommend the reflow temperature 245°C(+/-5°C). The maximum soldering temperature should be limited to 260°C.
2. Don't cause stress to the epoxy resin while it is exposed to high temperature.
3. Number of reflow process shall be 2 times or less.

Recommended Soldering Pattern (Units : mm; Tolerance: ± 0.1)

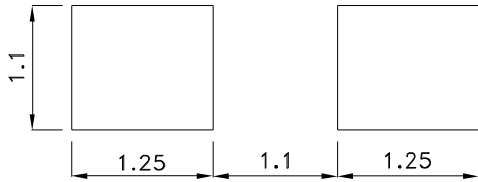

Reel Dimension

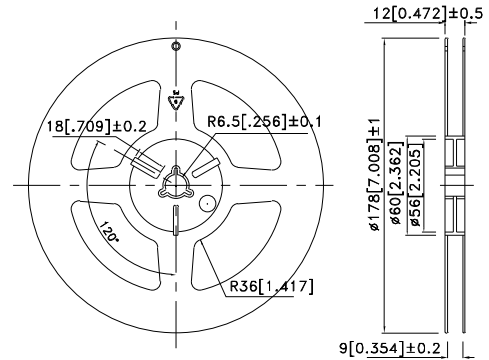

Tape Specifications (Units : mm)

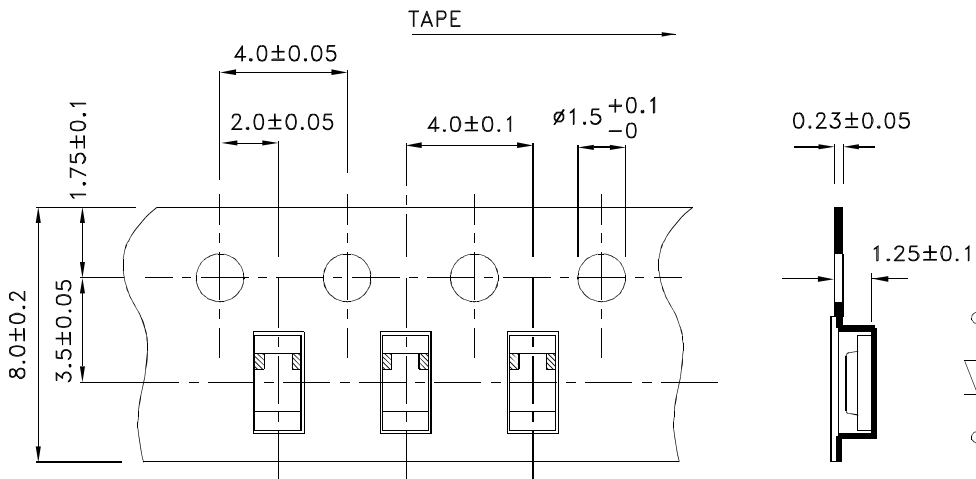

Kingbright

PACKING & LABEL SPECIFICATIONS

KP-2012SF4C

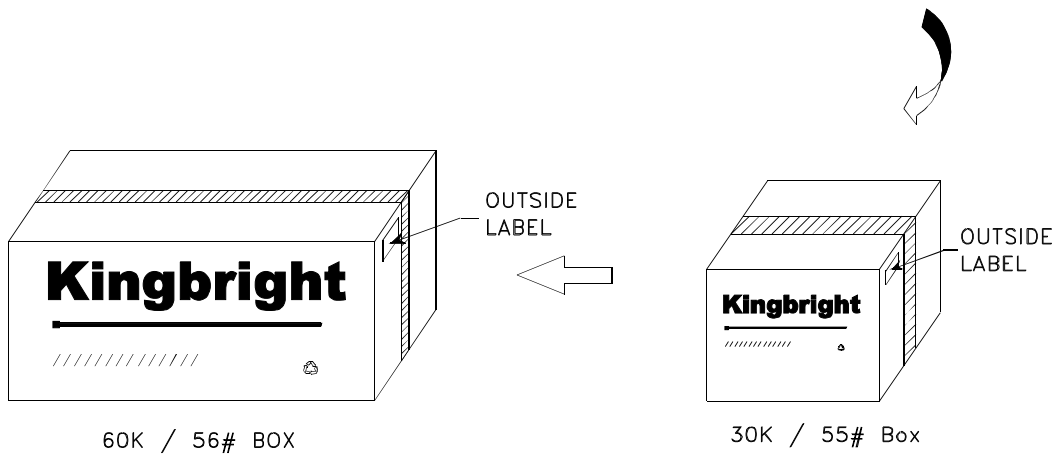
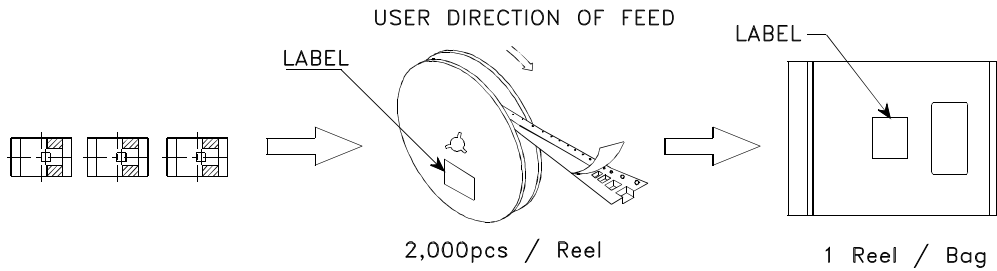

<h1>Kingbright</h1>	
P/NO: KP-2012xxx	
QTY: 2,000 pcs	Q.C. Q C XX XX XXXX PASSED
S/N: XXXX	
CODE: XXX	
LOT NO:	
 XXXXXXXXXXXXXXXXXXXXXXXXXXXX	
RoHS Compliant	