

Part Number: L-914AT

Amber

Features

- Low power consumption.
- Reliable and rugged.
- Excellent uniformity of light output.
- Suitable for level indicator.
- RoHS compliant.

Description

The Amber source color devices are made with Gallium Arsenide Phosphide on Gallium Phosphide Amber Light Emitting Diode.

Package Dimensions

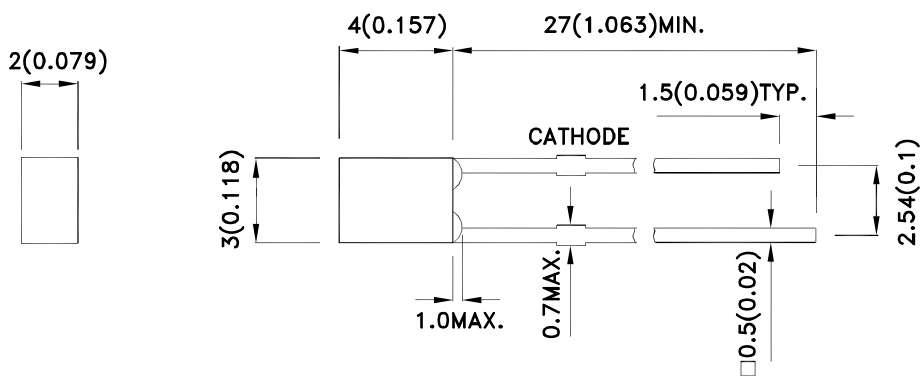

Notes:

1. All dimensions are in millimeters (inches).
2. Tolerance is $\pm 0.25(0.01)$ " unless otherwise noted.
3. Lead spacing is measured where the leads emerge from the package.
4. The specifications, characteristics and technical data described in the datasheet are subject to change without prior notice.



Selection Guide

| Part No. | Dice | Lens Type | Iv (mcd) [2] @ 10mA | | Viewing Angle [1] |
|----------|-------------------|-------------------|------------------------|------|----------------------|
| | | | Min. | Typ. | 2θ1/2 |
| L-914AT | Amber (GaAsP/GaP) | AMBER TRANSPARENT | 1.8 | 7 | 90° |

Notes:

1. θ1/2 is the angle from optical centerline where the luminous intensity is 1/2 of the optical peak value.
2. Luminous intensity/ luminous Flux: +/-15%.

Electrical / Optical Characteristics at TA=25°C

| Symbol | Parameter | Device | Typ. | Max. | Units | Test Conditions |
|--------------------|--------------------------|--------|------|------|-------|---------------------------|
| λ _{peak} | Peak Wavelength | Amber | 590 | | nm | I _F =20mA |
| λ _D [1] | Dominant Wavelength | Amber | 588 | | nm | I _F =20mA |
| Δλ _{1/2} | Spectral Line Half-width | Amber | 35 | | nm | I _F =20mA |
| C | Capacitance | Amber | 20 | | pF | V _F =0V;f=1MHz |
| V _F [2] | Forward Voltage | Amber | 2.1 | 2.5 | V | I _F =20mA |
| I _R | Reverse Current | Amber | | 10 | uA | V _R = 5V |

Notes:

1. Wavelength: +/-1nm.
2. Forward Voltage: +/-0.1V.

Absolute Maximum Ratings at TA=25°C

| Parameter | Amber | Units |
|-------------------------------|---------------------|-------|
| Power dissipation | 75 | mW |
| DC Forward Current | 30 | mA |
| Peak Forward Current [1] | 140 | mA |
| Reverse Voltage | 5 | V |
| Operating/Storage Temperature | -40°C To +85°C | |
| Lead Solder Temperature [2] | 260°C For 3 Seconds | |
| Lead Solder Temperature [3] | 260°C For 5 Seconds | |

Notes:

1. 1/10 Duty Cycle, 0.1ms Pulse Width.
2. 2mm below package base.
3. 5mm below package base.

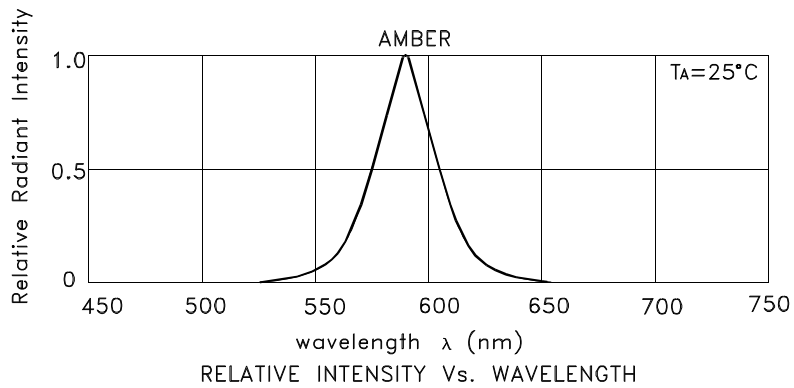

Amber

L-914AT

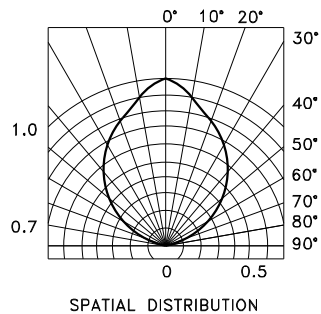
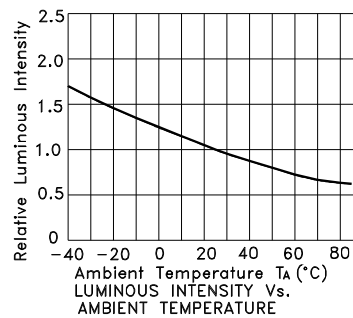
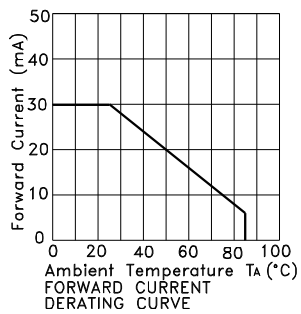
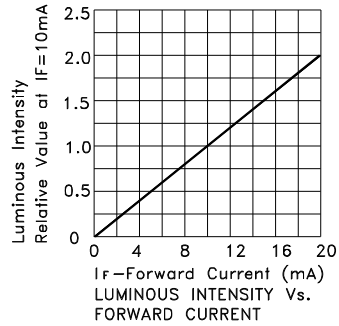
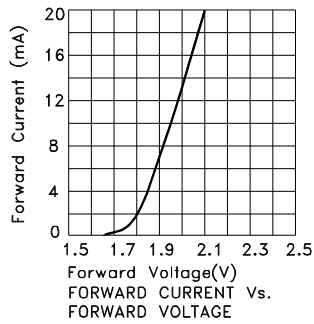

Kingbright

PACKING & LABEL SPECIFICATIONS

L-914AT

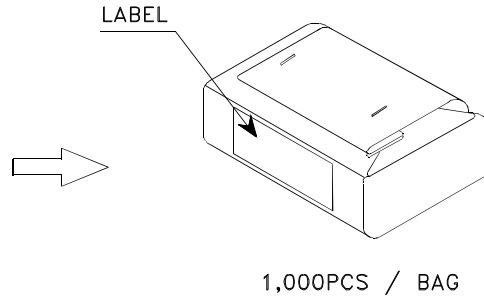
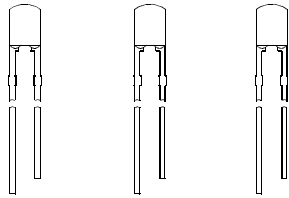

OUTSIDE LABEL

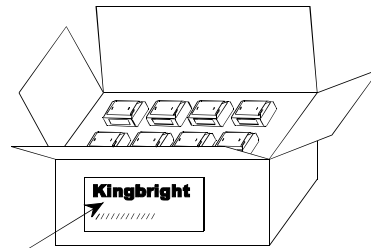
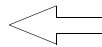

OUTSIDE LABEL

56K / 9# BOX

28K / 5# BOX

| | |
|--|--|
| <h1 style="margin: 0;">Kingbright</h1> | |
| P/NO: L-914xxx | |
| QTY: 1,000 pcs | Q.C. Q C XX XX XXXX PASSED |
| S/N: XXXX | |
| CODE: XXX | |
| LOT NO: | |
| | |
| xxxxxxxxxxxxxxxxxxxxxxxxxxxxxxxx | |
| RoHS Compliant | |

LED MOUNTING METHOD

1. The lead pitch of the LED must match the pitch of the mounting holes on the PCB during component placement. Lead-forming may be required to insure the lead pitch matches the hole pitch. Refer to the figure below for proper lead forming procedures.

(Fig. 1)

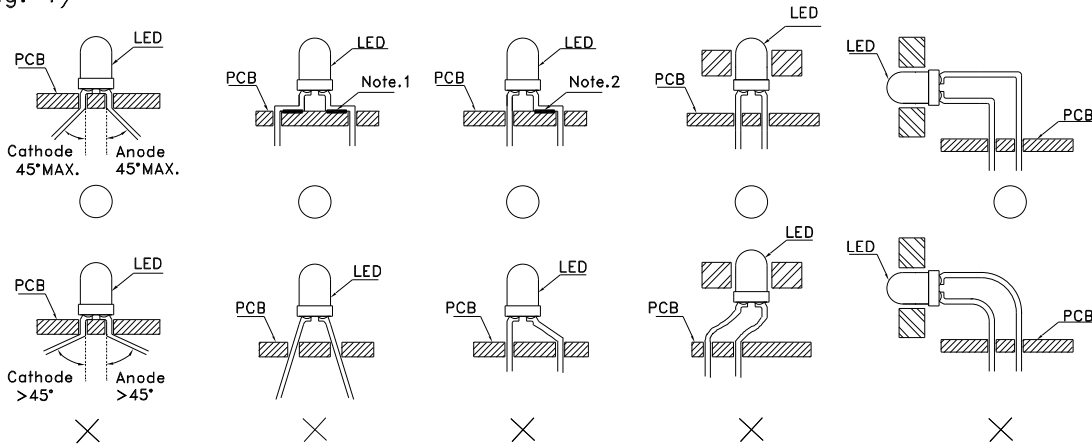

Fig.1

”O” Correct mounting method ”X” Incorrect mounting method

Note 1-2 : Do not route PCB trace in the contact area between the leadframe and the PCB to prevent short-circuits.

2. When soldering wire to the LED, use individual heat-shrink tubing to insulate the exposed leads to prevent accidental contact short-circuit.

(Fig. 2)

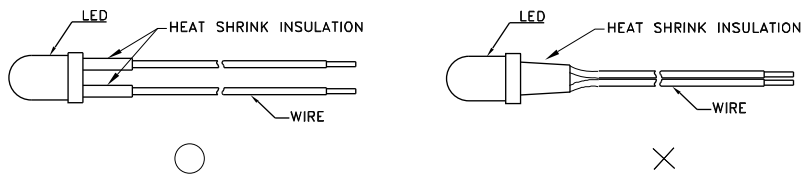

Fig. 2

3. Use stand-offs (Fig. 3) or spacers (Fig. 4) to securely position the LED above the PCB.

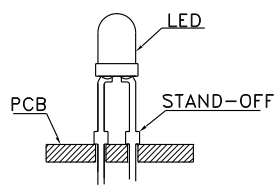

Fig. 3



Fig. 4

LEAD FORMING PROCEDURES

1. Maintain a minimum of 2mm clearance between the base of the LED lens and the first lead bend. (Fig. 5 and 6)

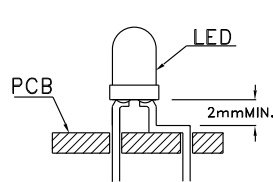

Fig. 5

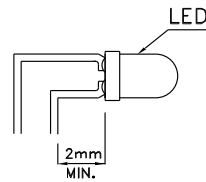

Fig. 6

2. Lead forming or bending must be performed before soldering, never during or after Soldering.
3. Do not stress the LED lens during lead-forming in order to fractures in the lens epoxy and damage the internal structures.
4. During lead forming, use tools or jigs to hold the leads securely so that the bending force will not be transmitted to the LED lens and its internal structures. Do not perform lead forming once the component has been mounted onto the PCB. (Fig. 7)
5. Do not bend the leads more than twice. (Fig. 8)

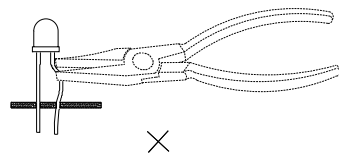

Fig. 7

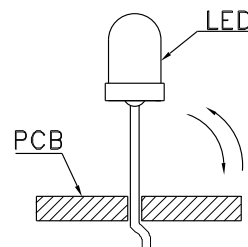

Fig. 8

6. After soldering or other high-temperature assembly, allow the LED to cool down to 50°C before applying outside force (Fig. 9). In general, avoid placing excess force on the LED to avoid damage. For any questions please consult with Kingbright representative for proper handling procedures.

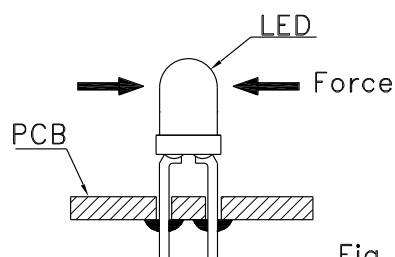

Fig. 9