

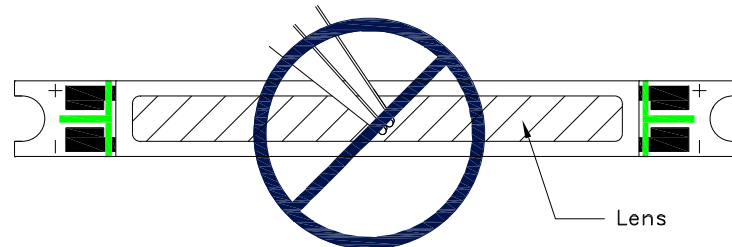

## Precautions

1. Do not touch the lens with any sharp object.
2. No stress should be applied on the lens.



3. Thermal grease between the light bar and heat sink is recommended to fill air gaps for better thermal conductivity.
4. For securing the LED light bar, M2 screws are recommended. The light bar should not be bent or stressed in any way which could damage the internal circuit.

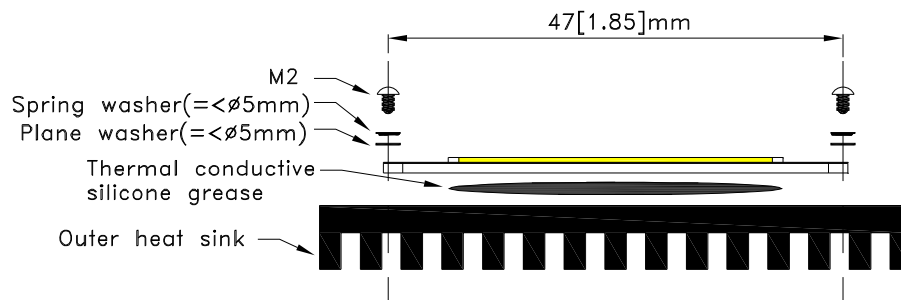

5. To prevent damages caused by electrostatic discharge (ESD), it is recommended to wear proper gear such as wristband or anti-static gloves when handling the product.
6. Constant current source is recommended to power the light bar. When more than one light bar are used, they should be connected in series if possible.
7. Thermal management should be taken into consideration when using the product. Maximum driving current should be reduced accordingly at higher ambient temperature to prevent overheating.
8. Soldering recommendations:
  - Soldering iron power should not exceed 40W, and should not be in contact with the joint for more than 3.5 secs.
  - The maximum soldering temperature should be less than 350°C.
  - Do not touch the product immediately after soldering.
  - Not reflow compatible.
9. As silicone encapsulation is permeable to gases, some corrosive substances such as H<sub>2</sub>S might corrode silver plating of leadframe. Special care should be taken if an LED with silicone encapsulation is to be used near such substances.

## Absolute Maximum Ratings

Parameter	Symbol	Rating	Units
Forward Current	I <sub>F</sub>	700	mA
Forward Pulse Current [1]	I <sub>FP</sub>	1000	mA
Power Dissipation	P <sub>d</sub>	8.12	W
LED Junction Temperature	T <sub>j</sub>	120	°C
Operating Temperature	T <sub>opr</sub>	-30~+100	°C
Storage Temperature	T <sub>stg</sub>	-40~+120	°C
Case Temperature	T <sub>c</sub>	100	°C

Note:

1. 1/10 Duty Cycle, 0.1ms Pulse Width.

## Electrical / Optical Characteristics

Part Name	Device	Parameter	Symbol	Min.	Typ.	Max.	Units	Conditions
KASL-4805QB25SX15/7	Blue	Forward Voltage [2]	V <sub>F</sub>	8.4	10.3	11.6	V	I <sub>F</sub> =700mA
		Luminous Flux [3]	Φ <sub>v</sub>	42	60	-	lm	I <sub>F</sub> =700mA
		Wavelength at peak emission[4]	λ <sub>peak</sub>	-	445	-	nm	I <sub>F</sub> =700mA
		Dominant Wavelength	λ <sub>dom</sub>	-	450	-	nm	I <sub>F</sub> =700mA
		Spectral bandwidth at 50%Φ <sub>REL</sub> MAX	Δλ <sub>1/2</sub>	-	20	-	nm	I <sub>F</sub> =700mA
		Temperature coefficient of λ <sub>peak</sub>	TCλ <sub>peak</sub>	-	0.12	-	nm/°C	I <sub>F</sub> =700mA
		Temperature coefficient of λ <sub>dom</sub>	TCλ <sub>dom</sub>	-	0.10	-	nm/°C	I <sub>F</sub> =700mA
		Temperature coefficient of Forward Voltage	ΔλV <sub>F</sub> /ΔT	-	-2.9	-	mV/°C	I <sub>F</sub> =700mA
		Thermal Resistance	R <sub>th j-c</sub>	-	3.5	-	°C/W	I <sub>F</sub> =700mA
		Emission Angle	2 θ 1/2 X direction	-	120	-	°	I <sub>F</sub> =700mA
2 θ 1/2 Y direction	-		120	-	°	I <sub>F</sub> =700mA		

Notes:

2. Forward Voltage is measured with an accuracy of +/-0.1V.

3. Flux is measured with an accuracy of +/-15%.

4. Wavelength : +/-0.1nm.

Test Item	Test Condition
Moisture-proof Test	85°C , 85%RH for 1000 hours

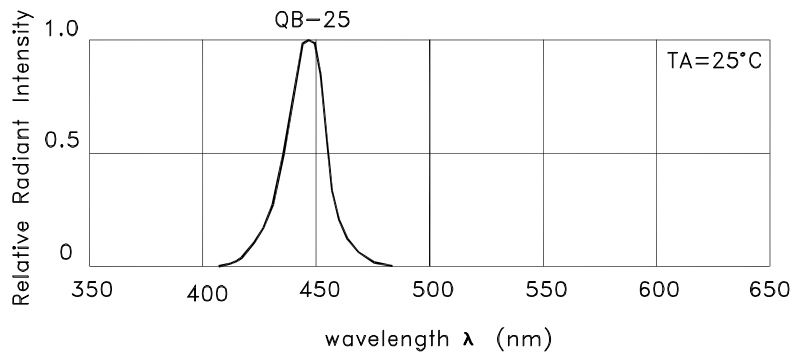

RELATIVE INTENSITY Vs. WAVELENGTH

Forward Current – Forward Voltage Characteristic

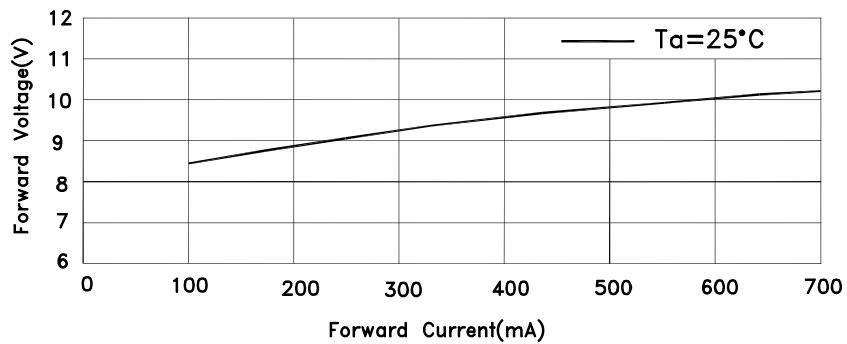

Forward Current – Relative Total Luminous Flux Characteristic

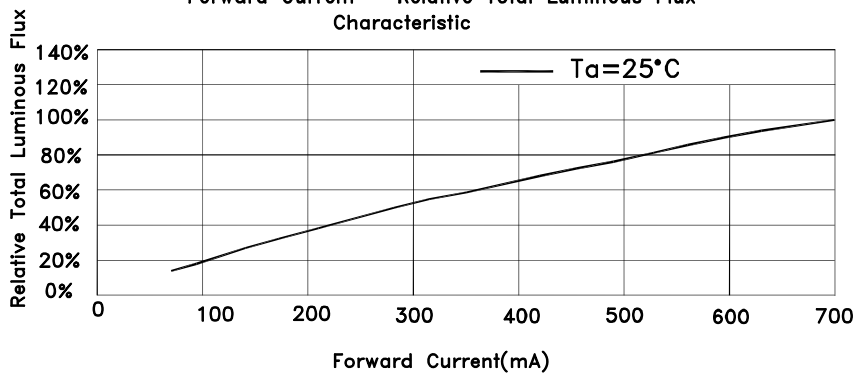

Forward Current – Relative Wavelength Change Characteristic

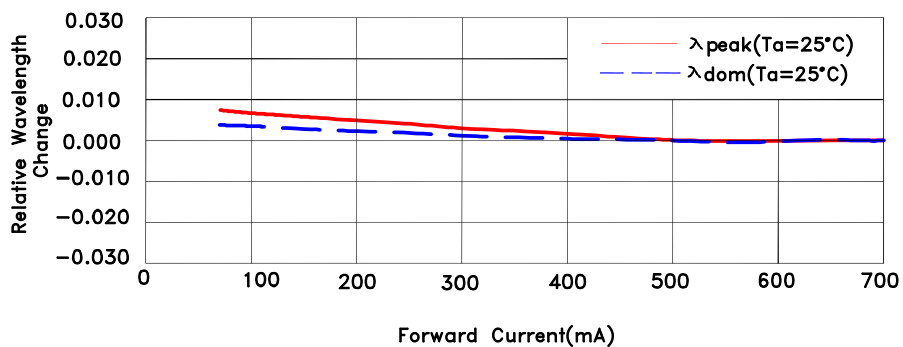

Ambient Temperature Ta – Forward Voltage Characteristic

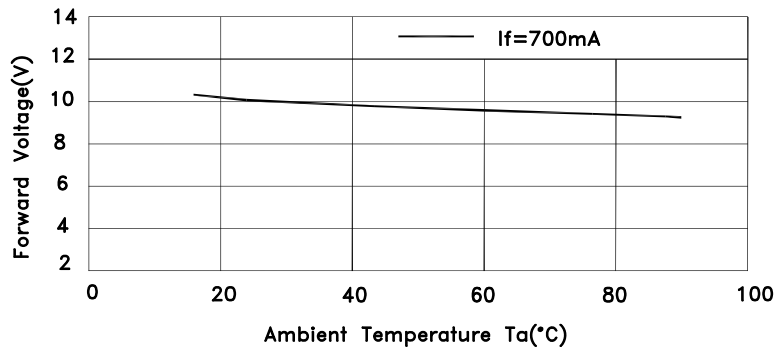

Ambient Temperature Ta – Relative Total Luminous Flux Characteristic

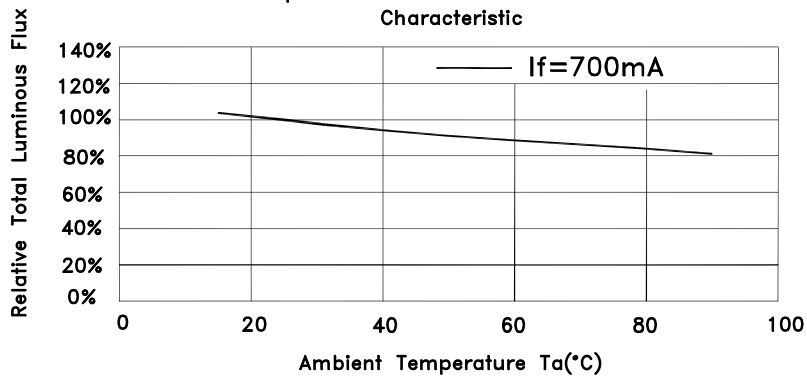

Ambient Temperature Ta – Relative Wavelength Change Characteristic

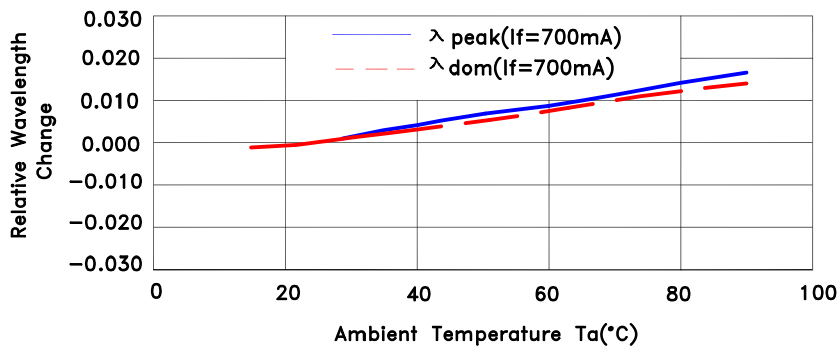

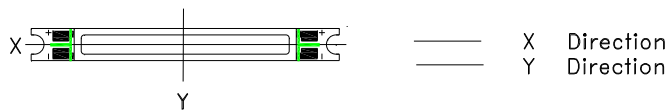
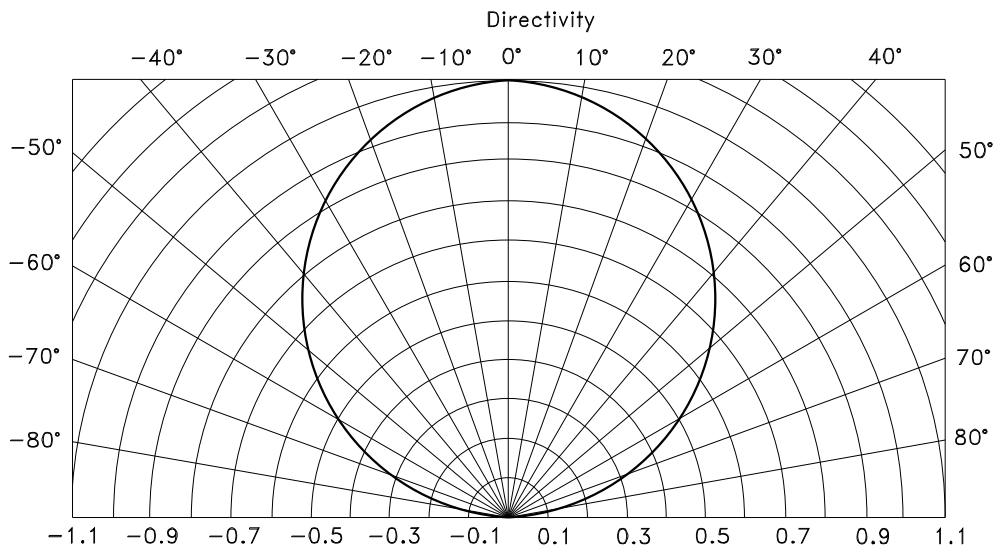
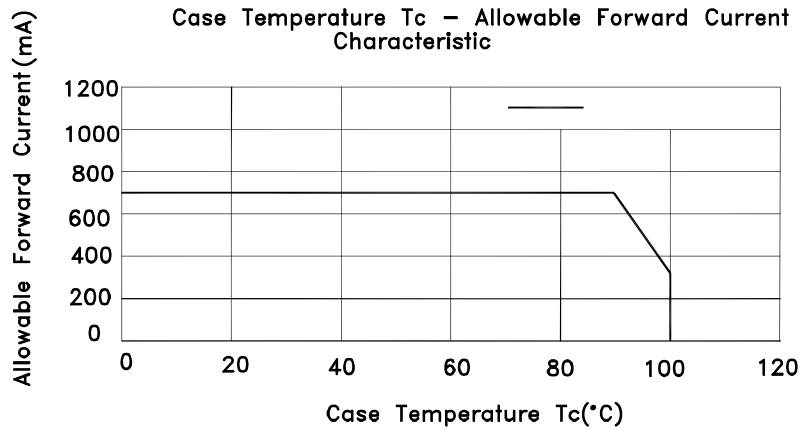

## PACKING & LABEL SPECIFICATIONS

KASL-4805QB25SX15/7

(1) Primary packing

50 pieces are contained in each tray.

Two trays which collectively contain 100 pieces are stacked together with an additional empty tray as lid.

Tray (Dimensions:398x218x12mm, materials:electrically conductive PS.)

(2) Secondary packing

A set of three trays is placed in bag. (100 pieces per bag.)

An indication label which specifies product name,quantity,lot number and shipment date is attached to the outside of the 9# box.(800 pieces per box.)

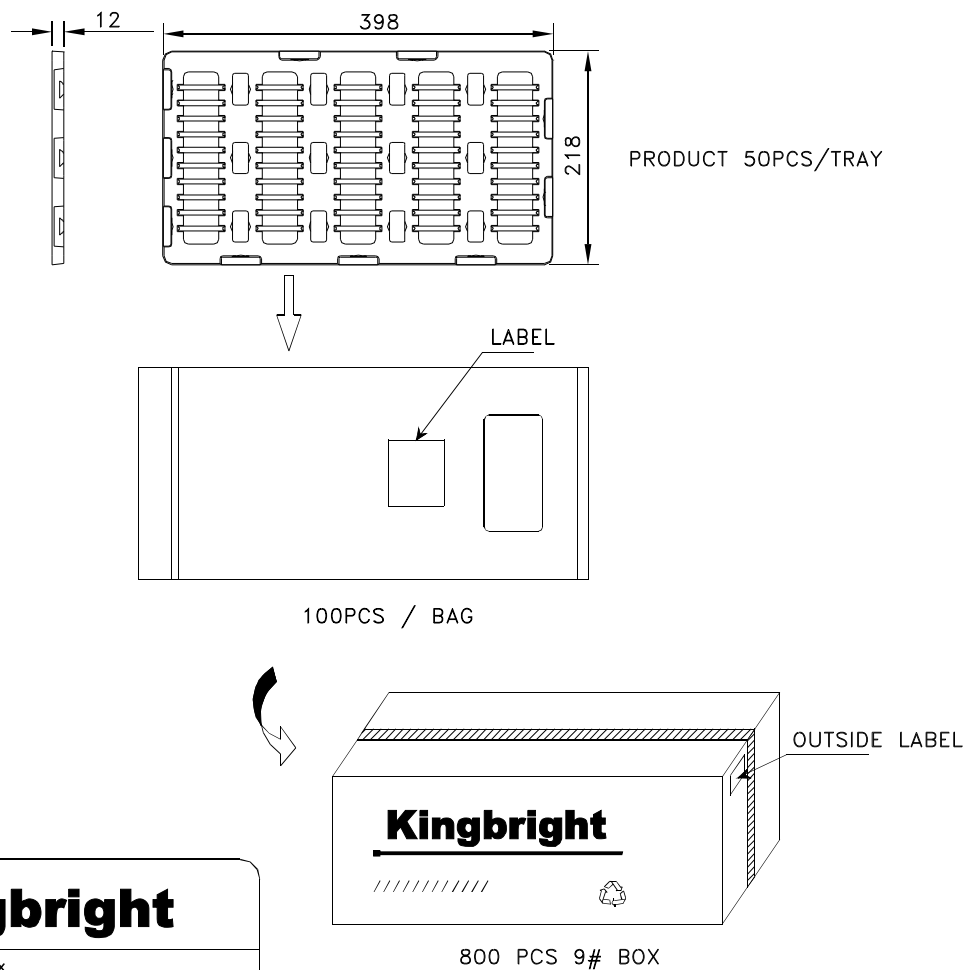

<b>Kingbright</b>	
P/N0: KASL-4805xxx	
QTY: 100 pcs	Q.C. <span style="border: 1px solid black; border-radius: 50%; padding: 2px;">Q C XX XX XXXX PASSED</span>
S/N: XXXX	
CODE: XXX	
LOT NO:	
 XXXXXXXXXXXXXXXX	
RoHS Compliant	

## KASL-4805 Application Note

### Introduction

The KASL-4805 LED light bar provide very high light output, and can be configured to suit a wide range of applications. However the heat generated during operation, if not handled properly, could shorten the product life significantly. Therefore for optimal performance, proper thermal management should be incorporated to keep it below the rated temperature. This document describes the heat sink attachment procedure.

### Attachment to Heat sink

1. Apply a thin layer (0.1 ~ 0.2 mm) of thermal grease on the bottom of the KASL-4805 LED light bar.



Rear surface

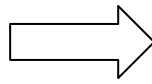

Thermal glue on rear surface

2. Press the KASL-4805 LED light bar firmly on the heat sink to ensure good contact between the heat sink and the LED light bar . A guide for heat sink size selection at various driving currents is listed in the table below.

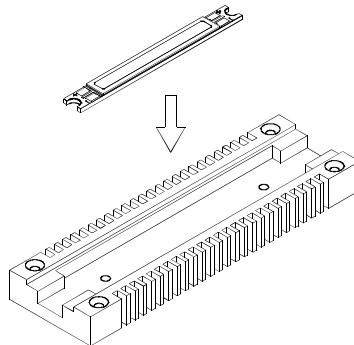

3. A specifically designed electronic circuit is required to power the LED light bar . Do not connect the product directly to the main power.

Current (mA)	350	500	600	700
Heat sink surface area (mm <sup>2</sup> )	10,000	15,000	17,000	21,000

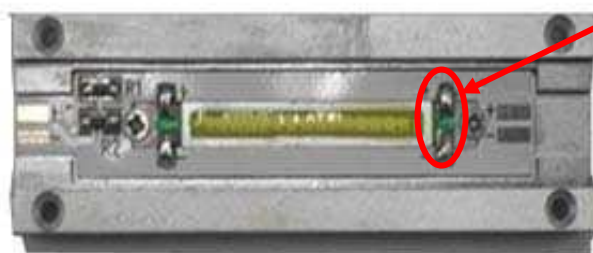

It is strongly recommended that temperature of pad be not higher than 75°C when you use the product.