

PRELIMINARY SPEC

Part Number: KTDS-3535QB14Z4S

Blue



ATTENTION
OBSERVE PRECAUTIONS
FOR HANDLING
ELECTROSTATIC
DISCHARGE
SENSITIVE
DEVICES

Absolute Maximum Ratings at T_A = 25°C

Parameter	Symbol	Value	Unit
DC Forward Current [1]	I _F	700	mA
Peak Forward Current [2]	I _{FM}	1000	mA
Power dissipation	P _D	2.8	W
Reverse Voltage	V _R	5	V
Operating Temperature	T _{op}	-40 To +100	°C
Storage Temperature	T _{stg}	-40 To +110	°C
Junction temperature[1]	T _J	110	°C
Thermal resistance [1] (Junction/ambient)	R _{th j-a}	30	°C/W
Thermal resistance [1] (Junction/solder point)	R _{th j-s}	15	°C/W

Notes:

1. Results from mounting on metal core PCB, mounted on pc board-metal core PCB is recommend for lowest thermal resistance.
2. 1/10 Duty Cycle, 0.1ms Pulse Width.

Electrical / Optical Characteristics at T_A = 25°C

Parameter	Symbol	Value	Unit
Wavelength at peak emission I _F = 350mA [Typ.]	λ _{peak}	455	nm
Dominant Wavelength I _F = 350mA [Typ.]	λ _{dom} [1]	460	nm
Spectral bandwidth at 50%Φ _{REL MAX} I _F = 350mA [Typ.]	Δλ	25	nm
Allowable Reverse Current [Max.]	I _R	85	mA
Forward Voltage I _F = 350mA [Min.]	V _F [2]	2.8	V
Forward Voltage I _F = 350mA [Typ.]		3.3	
Forward Voltage I _F = 350mA [Max.]		4.0	
Temperature coefficient of λ _{peak} I _F = 350mA, -10°C ≤ T ≤ 100°C [Typ.]	TC _{λpeak}	0.06	nm/°C
Temperature coefficient of λ _{dom} I _F = 350mA, -10°C ≤ T ≤ 100°C [Typ.]	TC _{λdom}	0.03	nm/°C
Temperature coefficient of V _F I _F = 350mA, -10°C ≤ T ≤ 100°C [Typ.]	TC _V	-2.3	mV/°C

Notes:

1. Wavelength : + / - 1nm.
2. Forward Voltage : + / - 0.1V.
3. Wavelength value is traceable to the CIE127-2007 compliant national standards.



Selection Guide

Part No.	Dice	Φ_v (lm) [2] @ 350mA			Typical Luminous Flux (lm) [2]	Viewing Angle [1]
		Code.	Min.	Max.	Typ.	2 θ 1/2
KTDS-3535QB14Z4S	Blue (InGaN)	B3	14	17	18	110°
		B4	17	20		
		B5	20	24		

Notes:

1. θ 1/2 is the angle from optical centerline where the luminous intensity is 1/2 of the optical peak value.
2. Luminous intensity / luminous flux: +/-15%.
3. Luminous Flux value is traceable to the CIE127-2007 compliant national standards.

Package Dimension And Materials

For package dimension please refer to page 10

Material as follows: Package : Ceramics
 Encapsulating resin : Silicone resin
 Electrodes : Ag plating

Features

1. Dimensions : 3.45mm X 3.45mm X 2.0mm.
2. Small package with high efficiency.
3. Surface mount technology.
4. Soldering methods: IR reflow soldering.
6. Moisture sensitivity level : level 1.
7. Electrically neutral thermal path.
8. RoHS compliant.

Packaging:

1. The LEDs are packed in cardboard boxes after taping.
2. The label on the minimum packing unit shows: Part Number, Lot Number, Ranking, Quantity.
3. In order to protect the LEDs from mechanical shock, we pack them in cardboard boxes for transportation.
4. The LEDs may be damaged if the boxes are dropped or receive a strong impact against them, so precautions must be taken to prevent any damage.
5. The boxes are not water resistant and therefore must be kept away from water and moisture.
6. When the LEDs are transported, we recommend that you use the same packing methods as Kingbright's.

Reliability Test Items And Conditions

The reliability of products shall be satisfied with items listed below

Lot Tolerance Percent Defective (LTPD) : 10%

No.	Test Item	Standards	Test Condition	Test Times / Cycles	Number of Damaged
1	Continuous operating test	-	Ta = 25°C +10/-5°C ,RH=55+/-20%RH IF = maximum rated current*	1,000 h	0 / 22
2	High Temp. operating test	-	Ta = 100°C(+/-10°C) IF = maximum rated current*	1,000 h	0 / 22
3	Low Temp. operating test	-	Ta = -40°C+3/-5°C IF = maximum rated current*	1,000 h	0 / 22
4	High temp. storage test	JEITA ED-4701/200 201	Ta = 100°C(+/-10°C) Ta = maximum rated storage temperature	1,000 h	0 / 22
5	Low temp. storage test	JEITA ED-4701/200 202	Ta = -40°C+3/-5°C	1,000 h	0 / 22
6	High temp. & humidity storage test	JEITA ED-4701/100 103	Ta = 60°C+5/-3°C, RH = 90+5/-10%RH	1,000 h	0 / 22
7	High temp. & humidity operating test	-	Ta = 60°C+5/-3°C, RH = 90%+5/-10%RH IF = maximum rated current*	500h	0 / 22
8	Resistance to Soldering Heat (Reflow Soldering)	JEITA ED-4701/300 301	Tsld=260°C, 10sec	1 time	0 / 22
9	Solderability (Reflow Soldering)	JEITA ED-4701/300 303	Tsld=245°C+/-5°C, 5+/-1sec	1 time over 95%	0 / 22
10	Temperature Cycle operating test	-	-40°C(30min) ~25°C(5min)~-100°C (30min) ~25°C(5min) IF = derated current at 100°C	10cycles	0 / 22
11	Temperature Cycle	JEITA ED-4701/100 105	-40°C(30min) ~25°C(5min)~-100°C (30min) ~25°C(5min)	100cycles	0 / 22
12	Thermal shock test	MIL-STD-202G	Ta = -40°C(15min) ~100°C(15min)	500 cycles	0 / 22
13	Electric Static Discharge (ESD)	JEITA ED-4701/300 304	C = 100pF , R= 1.5KΩ V = 2kV	3 times Negative/ Positive	0 / 22
14	Vibration test	JEITA ED-4701/400 403	100~2000~100HZ Sweep 4min. 200m/s ² 3directions,4cycles	48min.	0 / 22

* : Refer to forward current vs. derating curve diagram.

Failure Criteria

Item	Symbol	Test Conditions	Criteria for Judgement	
			Min.	Max.
Forward Voltage	V _F	I _F = 350mA	-	Initial Level x 1.1
Luminous Flux	Φ _v	I _F = 350mA	Initial Level x 0.7	-

Note: The test is performed after the board is cooled down to the room temperature.

JEDEC Moisture Sensitivity:

Level	Floor Life		Soak Requirements			
			Standard		Accelerated Equivalent	
	Time	Conditions	Time (hours)	Conditions	Time (hours)	Conditions
1	Unlimited	≤ 30 °C / 85% RH	168 + 5 / - 0	85 °C / 85% RH		

Moisture Sensitivity Levels

Level	Floor Life		Soak Requirements			
			Standard		Accelerated Equivalent ¹	
	Time	Conditions	Time (hours)	Conditions	Time (hours)	Conditions
1	Unlimited	≤ 30 °C / 85% RH	168 + 5 / - 0	85 °C / 85% RH		
2	1 year	≤ 30 °C / 60% RH	168 + 5 / - 0	85 °C / 60% RH		
2a	4 weeks	≤ 30 °C / 60% RH	696 ² + 5 / - 0	30 °C / 60% RH	120 + 1 / - 0	60 °C / 60% RH
3	168 hours	≤ 30 °C / 60% RH	192 ² + 5 / - 0	30 °C / 60% RH	40 + 1 / - 0	60 °C / 60% RH
4	72 hours	≤ 30 °C / 60% RH	96 ² + 2 / - 0	30 °C / 60% RH	20 + 0.5 / - 0	60 °C / 60% RH
5	48 hours	≤ 30 °C / 60% RH	72 ² + 2 / - 0	30 °C / 60% RH	15 + 0.5 / - 0	60 °C / 60% RH
5a	24 hours	≤ 30 °C / 60% RH	48 ² + 2 / - 0	30 °C / 60% RH	10 + 0.5 / - 0	60 °C / 60% RH
6	Time on Label (TOL)	≤ 30 °C / 60% RH	TOL	30 °C / 60% RH		

Notes:

- CAUTION - The "accelerated equivalent" soak requirements **shall not** be used until correlation of damage response, including electrical, after soak and reflow is established with the "standard" soak requirements or if the known activation energy for diffusion is 0.4 - 0.48 eV. Accelerated soak times may vary due to material properties, e.g., mold compound, encapsulant, etc. JEDEC document JESD22-A120 provides a method for determining the diffusion coefficient.
- The standard soak time includes a default value of 24 hours for semiconductor manufacturer's exposure time (MET) between bake and bag and includes the maximum time allowed out of the bag at the distributor's facility.
If the actual MET is less than 24 hours the soak time may be reduced. For soak conditions of 30 °C/60% RH the soak time is reduced by one hour for each hour the MET is less than 24 hours. For soak conditions of 60 °C/60% RH, the soak time is reduced by one hour for each five hours the MET is less than 24 hours.
If the actual MET is greater than 24 hours the soak time must be increased. If soak conditions are 30 °C/60% RH, the soak time is increased one hour for each hour that the actual MET exceeds 24 hours. If soak conditions are 60 °C/60% RH, the soak time is increased one hour for each five hours that the actual MET exceeds 24 hours.
- Supplier may extend the soak times at their own risk.

ESD Protection During Production

Electric static discharge can result when static-sensitive products come in contact with the operator or other conductors.

The following procedures may decrease the possibility of ESD damage:

- Minimize friction between the product and surroundings to avoid static buildup.
- All production machinery and test instruments must be electrically grounded.
- Operators must wear anti-static bracelets.
- Wear anti-static suit when entering work areas with conductive machinery.
- Set up ESD protection areas using grounded metal plating for component handling.
- All workstations that handle IC and ESD-sensitive components must maintain an electrostatic potential of 150V or less.
- Maintain a humidity level of 50% or higher in production areas.
- Use anti-static packaging for transport and storage.
- All anti-static equipment and procedures should be periodically inspected and evaluated for proper functionality.

Handling Precautions

Compare to epoxy encapsulant that is hard and brittle, silicone is softer and flexible. Although its characteristic significantly reduces thermal stress, it is more susceptible to damage by external mechanical force.

As a result, special handling precautions need to be observed during assembly using silicone encapsulated LED products. Failure to comply might lead to damage and premature failure of the LED.

1. Handle the component along the side surfaces by using forceps or appropriate tools.

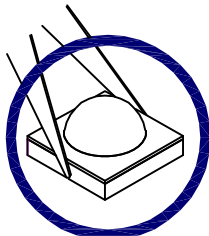

2. Do not directly touch or handle the silicone lens surface. It may damage the internal circuitry.

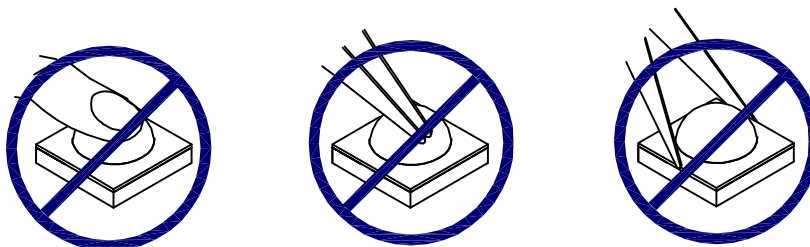

3. Do not stack together assembled PCBs containing exposed LEDs. Impact may scratch the silicone lens or damage the internal circuitry.



- 4.1. There should be enough space inside the nozzle to avoid contact with the dome lens during pick up.
- 4.2. The inner diameter of the SMD pickup nozzle should not exceed the size of the LED to prevent air leaks.
- 4.3. A pliable material is suggested for the nozzle tip to avoid scratching or damaging the LED surface during pickup.
- 4.4. The dimensions of the component must be accurately programmed in the pick-and-place machine to insure precise pickup and avoid damage during production.

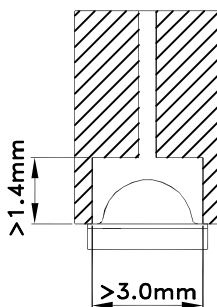

5. As silicone encapsulation is permeable to gases, some corrosive substances such as H_2S might corrode silver plating of leadframe. Special care should be taken if an LED with silicone encapsulation is to be used near such substances.

Designing the Position of LED on a Board.

1.No twist/warp/bent/or other stress shall be applied to the board after mounting LED with solder to avoid a crack of LED package.

Refer to the following recommended position and direction of LED.

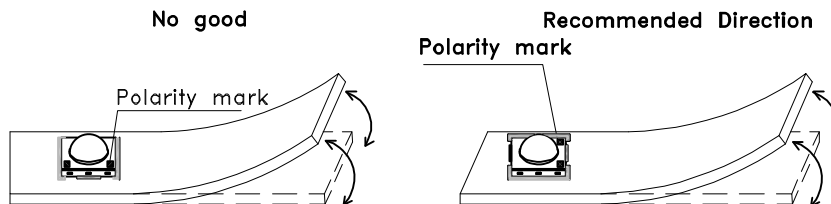

Appropriate LED mounting is to place perpendicularly against the stress affected side.

2.Depending on the position and direction of LED,the mechanical stress on the LED package can be changed.

Refer to the following figure.

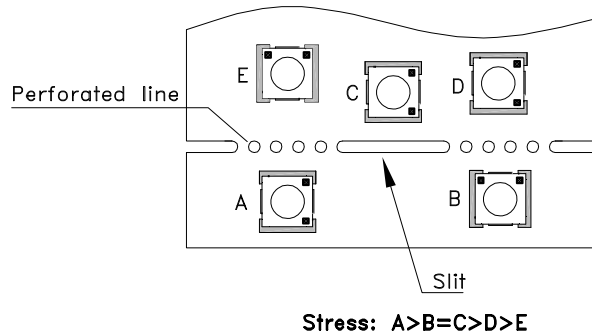

3.Do not split board by hand.Split with exclusive special tool.

4.If an aluminum circuit board is used,a large stress by thermal shock might cause a solder crack.

For this reason,it is recommended an appropriate verification should be taken before use.

Reflow soldering is recommended and the soldering profile is shown below. Other soldering methods are not recommended as they might cause damage to the product.

Reflow Soldering Profile For Lead-free SMT Process.

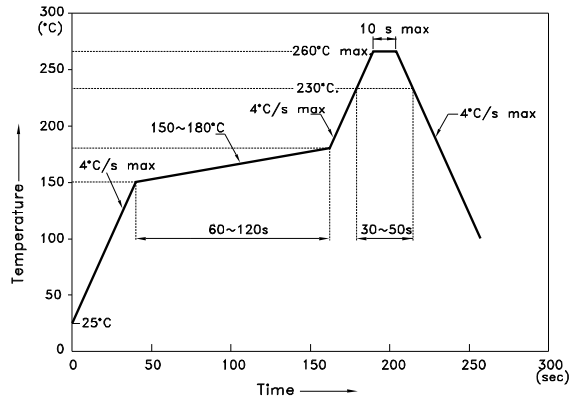

NOTES:

1. We recommend the reflow temperature 245°C (+/-5°C). The maximum soldering temperature should be limited to 260°C.
2. Don't cause stress to the epoxy resin while it is exposed to high temperature.
3. Number of reflow process shall be 2 times or less.

Heat Generation:

1. Thermal design of the end product is of paramount importance. Please consider the heat generation of the LED when making the system design. The coefficient of temperature increase per input electric power is affected by the thermal resistance of the circuit board and density of LED placement on the board, as well as other components. It is necessary to avoid intense heat generation and operate within the maximum ratings given in this specification.

2. Please determine the operating current with consideration of the ambient temperature local to the LED and refer to the plot of Permissible Forward current vs. Ambient temperature on CHARACTERISTICS in this specification. Please also take measures to remove heat from the area near the LED to improve the operational characteristics on the LED.

3. The equation ① indicates correlation between T_j and T_a , and the equation ② indicates correlation between T_j and T_s

$$T_j = T_a + R_{thj-a} * W \dots\dots\dots \textcircled{1}$$

$$T_j = T_s + R_{thj-s} * W \dots\dots\dots \textcircled{2}$$

T_j = dice junction temperature: °C

T_a = ambient temperature: °C

T_s = solder point temperature: °C

R_{thj-a} = heat resistance from dice junction temperature to ambient temperature : °C / W

R_{thj-s} = heat resistance from dice junction temperature to T_s measuring point : °C / W

W = inputting power ($I_F \times V_F$) : W

Blue

KTDS-3535QB14Z4S

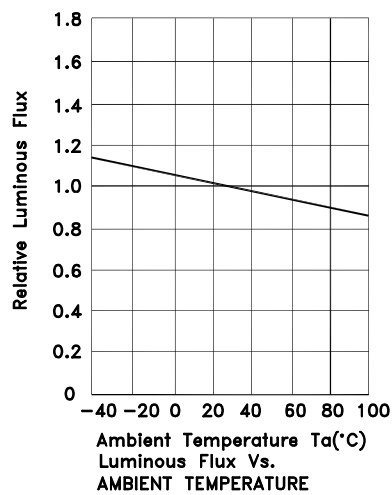
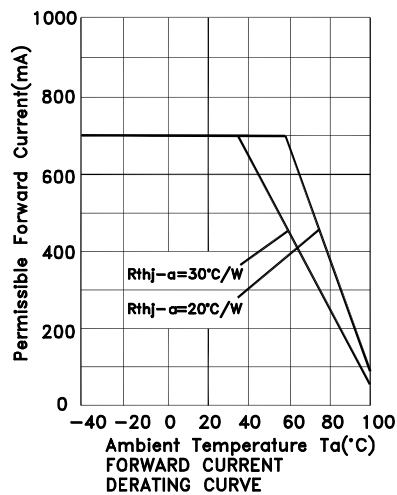
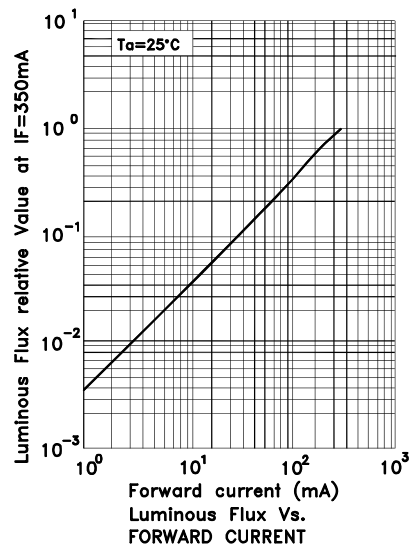
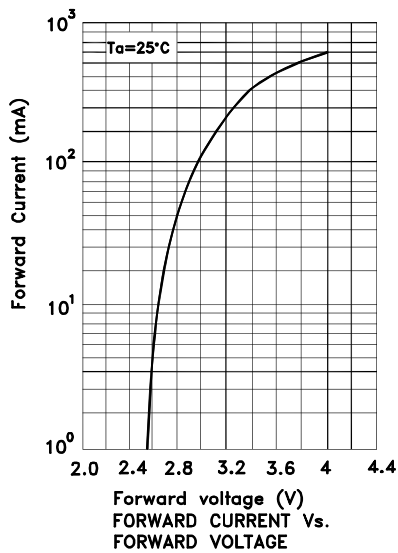
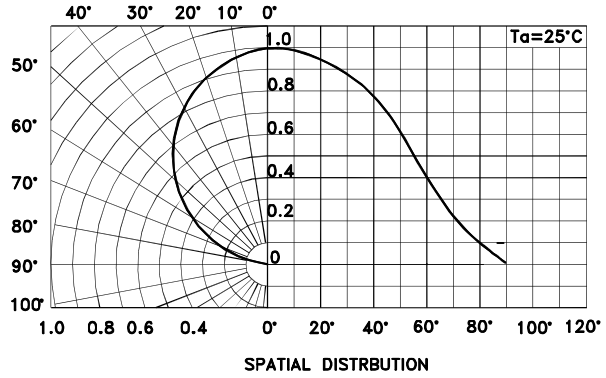
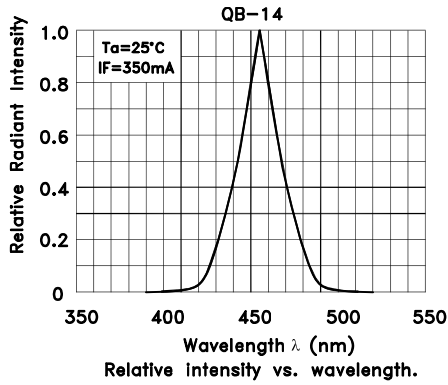

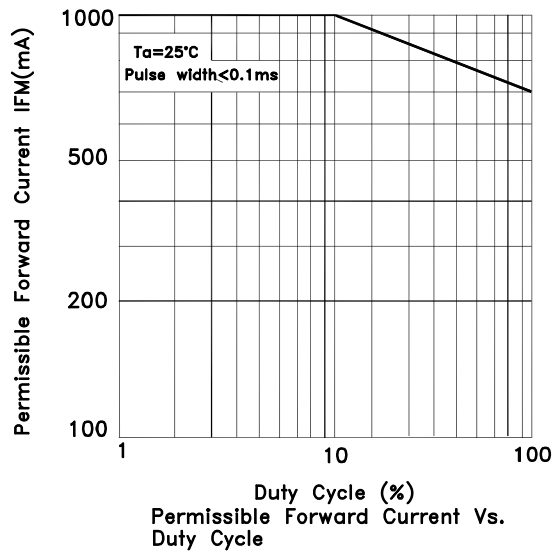
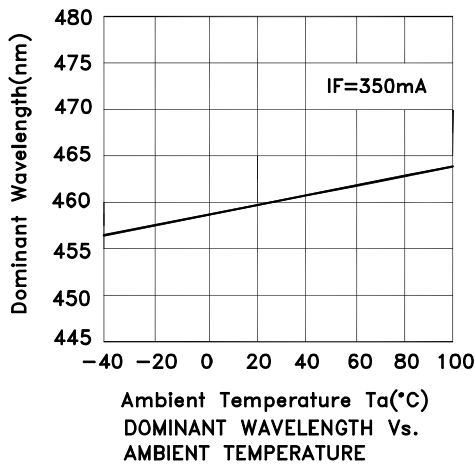
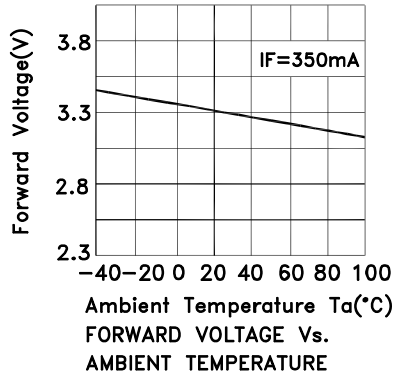

Package Dimensions

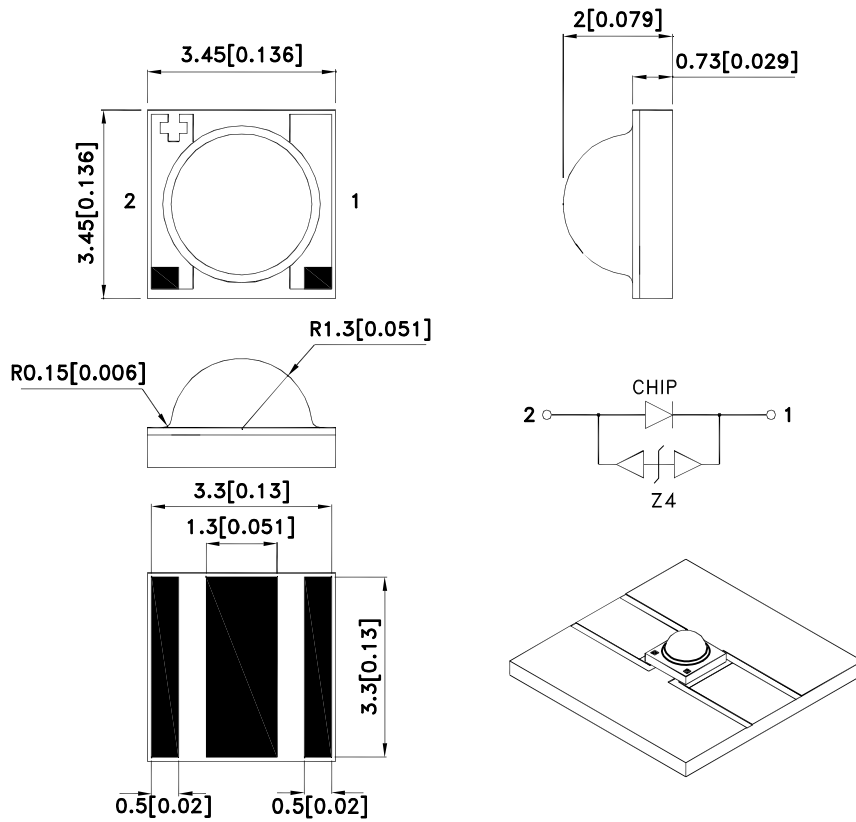

Notes:

1. All dimensions are in millimeters (inches).
2. Tolerance is ± 0.2 (0.008") unless otherwise noted.
3. The specifications, characteristics and technical data described in the datasheet are subject to change without prior notice.
4. The device has a single mounting surface. The device must be mounted according to the specifications.

Recommended Soldering Pattern (Units : mm ; Tolerance: ± 0.1)

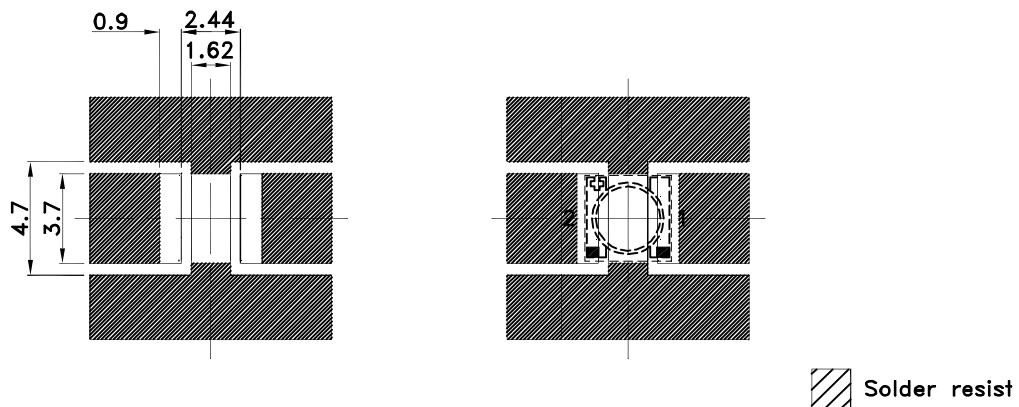

Tape Dimensions (Units : mm)

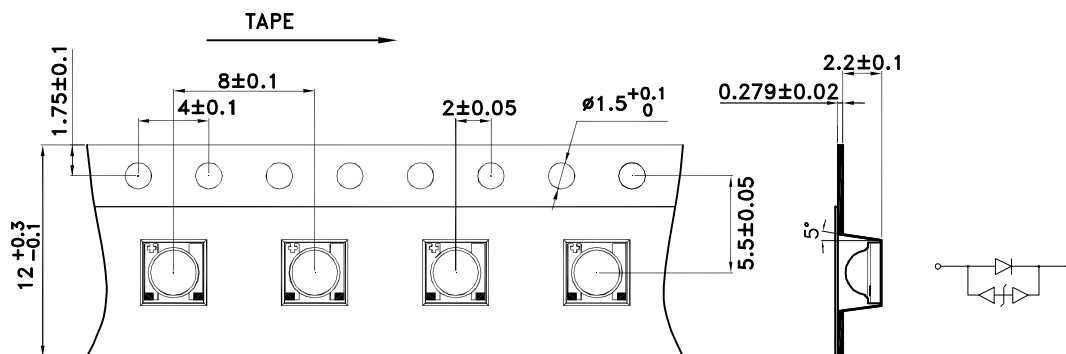

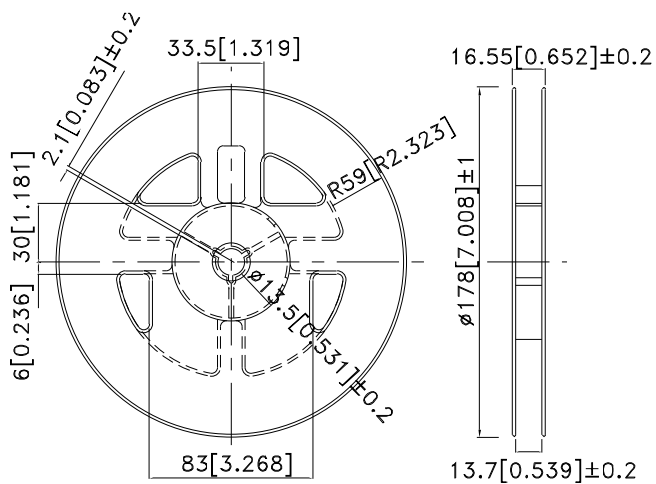

Reel Dimension

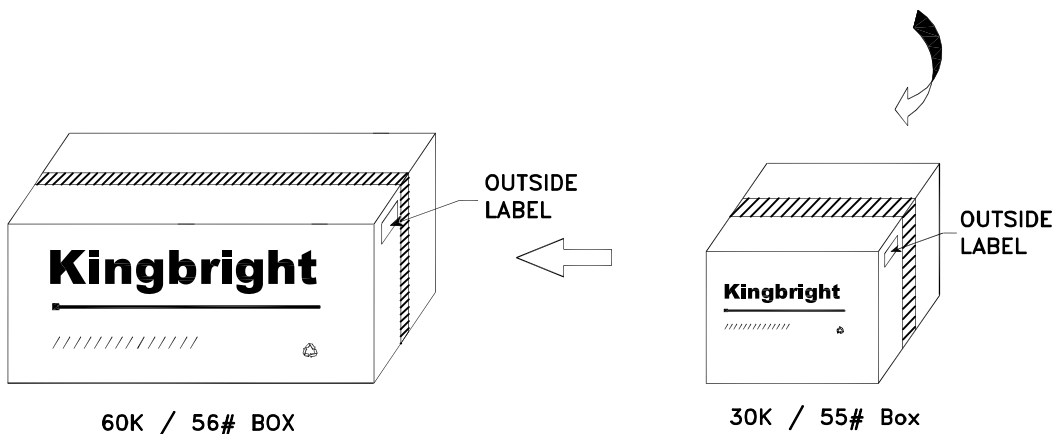
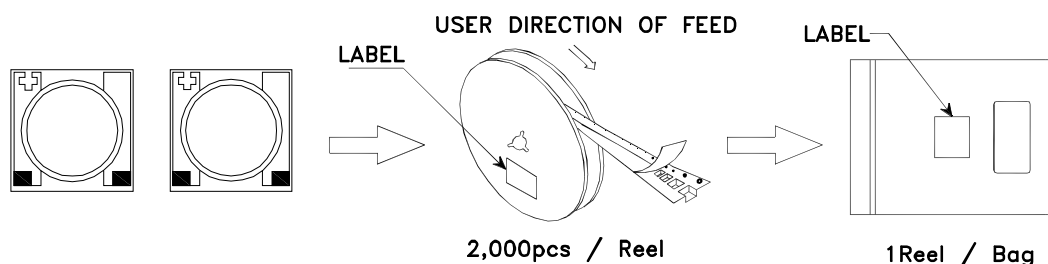

Packing & Label Specifications

KTDS-3535QB14Z4S



<h1>Kingbright</h1>	
P/NO: KTDS-3535xxx	
QTY: 2,000 pcs	Q.C. Q C xx xx xxxx PASSED
S/N: XXXX	
CODE: CIE:XXX	
LOT NO:	
 xxxxxxxxxxxxxxxxxxxxxxxxxxxx	
RoHS Compliant	