

# M54580P/FP

7-UNIT 150mA SOURCE TYPE DARLINGTON TRANSISTOR ARRAY

## DESCRIPTION

M54580P and M54580FP are seven-circuit output-sourcing Darlington transistor arrays. The circuits are made of PNP and NPN transistors. Both the semiconductor integrated circuits perform high-current driving with extremely low input-current supply.

## FEATURES

- High breakdown voltage ( $BV_{CEO} \geq 50V$ )
- High-current driving ( $I_o(max) = -150mA$ )
- Active L-level input
- With input diodes
- Wide operating temperature range ( $T_a = -20$  to  $+75^\circ C$ )

## APPLICATION

Drives of relays, printers and indication elements such as LEDs, fluorescent display tubes and lamps, and interfaces between MOS-bipolar logic systems and relays, solenoids, or small motors

## FUNCTION

The M54580P and M54580FP each have seven circuits, which are made of output current-sourcing Darlington transistors consisting of PNP and NPN transistors. Each PNP transistor has a diode and resistance of  $7k\Omega$  between the base and input pin. Its emitter and NPN transistor collectors are connected to the  $V_s$  pin (pin 9). Resistance of  $50k\Omega$  is connected between each output pin and GND pin (pin 8). Output current is 150mA maximum. Supply voltage  $V_s$  is 50V maximum.

The M54580FP is enclosed in a molded small flat package, enabling space-saving design.

## PIN CONFIGURATION

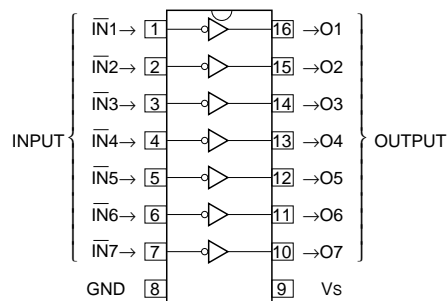

16P4(P)  
Package type 16P2N-A(FP)

## CIRCUIT DIAGRAM

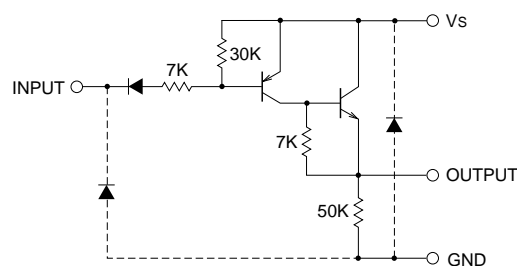

The seven circuits share the  $V_s$  and GND.  
The diode, indicated with the dotted line, is parasitic, and cannot be used.

Unit :  $\Omega$

## ABSOLUTE MAXIMUM RATINGS (Unless otherwise noted, $T_a = -20 \sim +75^\circ C$ )

Symbol	Parameter	Conditions	Ratings	Unit
$V_{CEO}$	Collector-emitter voltage	Output, L	-0.5 ~ +50	V
$V_s$	Supply voltage		50	V
$V_i$	Input voltage		-0.5 ~ $V_s$	V
$I_o$	Output current	Current per circuit output, H	-150	mA
$P_d$	Power dissipation	$T_a = 25^\circ C$ , when mounted on board	1.47(P)/1.00(FP)	W
$T_{opr}$	Operating temperature		-20 ~ +75	$^\circ C$
$T_{stg}$	Storage temperature		-55 ~ +125	$^\circ C$

# M54580P/FP

## 7-UNIT 150mA SOURCE TYPE DARLINGTON TRANSISTOR ARRAY

### RECOMMENDED OPERATING CONDITIONS (Unless otherwise noted, Ta = -20 ~ +75°C)

Symbol	Parameter	Limits			Unit	
		min	typ	max		
Vs	Supply voltage	4	—	50	V	
Io	Output current (Current per 1 circuit when 7 circuits are coming on simultaneously)	Duty Cycle P : no more than 85% FP : no more than 50%	0	—	-100	mA
		Duty Cycle P : no more than 100% FP : no more than 100%	0	—	-50	
VIH	"H" input voltage	Vs-0.4	—	Vs	V	
VIL	"L" input voltage	0	—	Vs-3.2	V	

### ELECTRICAL CHARACTERISTICS (Unless otherwise noted, Ta = -20 ~ +75°C)

Symbol	Parameter	Test conditions	Limits			Unit
			min	typ*	max	
V (BR) CEO	Collector-emitter breakdown voltage	ICEO = 100μA	50	—	—	V
VCE (sat)	Collector-emitter saturation voltage	VI = Vs-3.2V, Io = -100mA	—	0.9	1.5	V
		VI = Vs-3.2V, Io = -50mA	—	0.8	1.2	
Ii	Input current	VI = Vs-3.5V	—	-0.3	-0.6	mA
		VI = Vs-6V	—	-0.65	-0.95	
IR	Clamping diode reverse current	VI = 40V	—	—	100	μA
hFE	DC amplification factor	VCE = 4V, Vs = 10V, Ic = -100mA, Ta = 25°C	800	3000	—	—

\* : The typical values are those measured under ambient temperature (Ta) of 25°C. There is no guarantee that these values are obtained under any conditions.

### SWITCHING CHARACTERISTICS (Unless otherwise noted, Ta = 25°C)

Symbol	Parameter	Test conditions	Limits			Unit
			min	typ	max	
ton	Turn-on time	CL = 15pF (note 1)	—	200	—	ns
toff	Turn-off time		—	7500	—	ns

### NOTE 1 TEST CIRCUIT

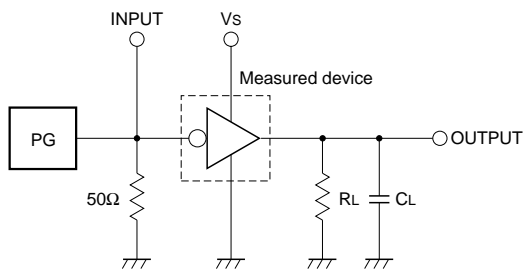

- (1) Pulse generator (PG) characteristics : PRR = 1kHz,  
tw = 10μs, tr = 6ns, tf = 6ns, Zo = 50Ω  
VI = 0.8 to 4V
- (2) Input-output conditions : RL = 40Ω, Vs = 4V
- (3) Electrostatic capacity CL includes floating capacitance at connections and input capacitance at probes

### TIMING DIAGRAM

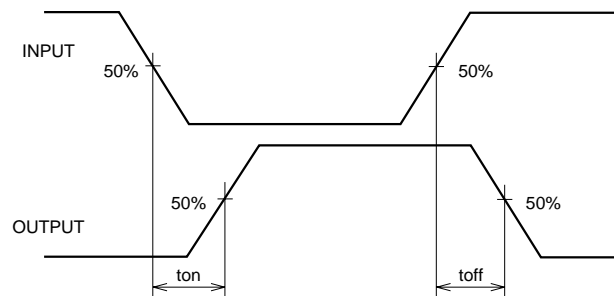

# M54580P/FP

## 7-UNIT 150mA SOURCE TYPE DARLINGTON TRANSISTOR ARRAY

### TYPICAL CHARACTERISTICS

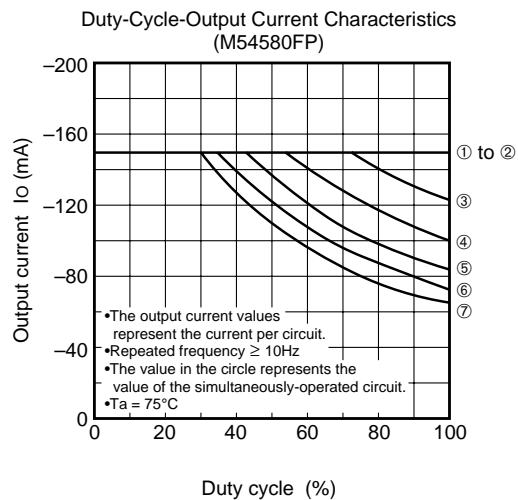
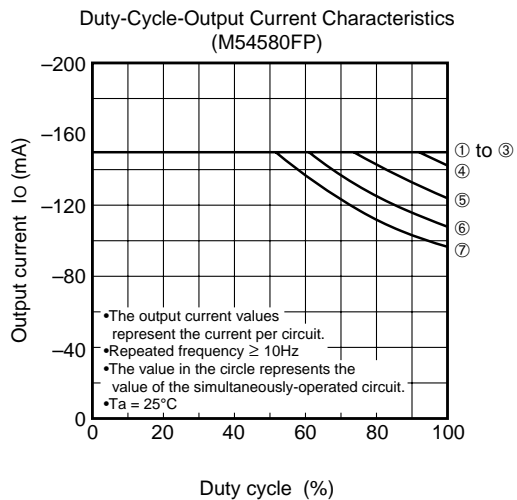
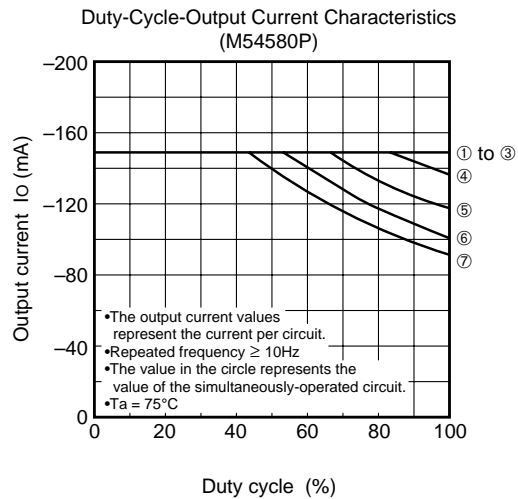
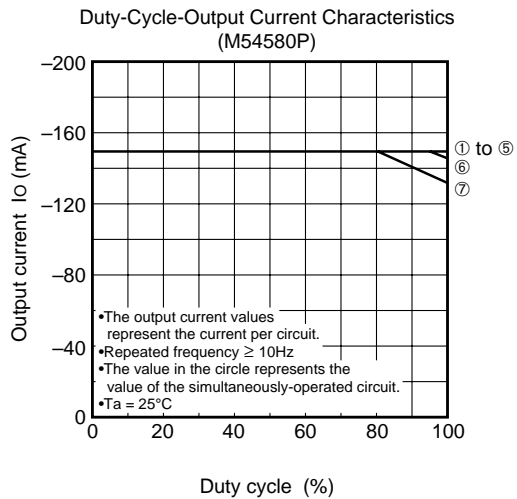
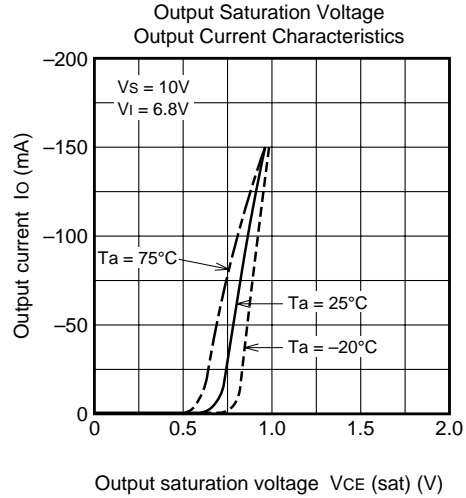
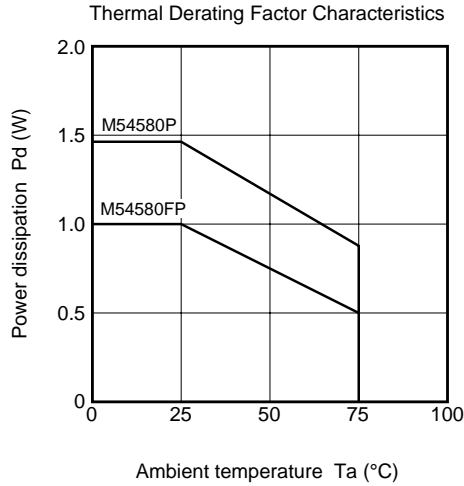

**M54580P/FP**

7-UNIT 150mA SOURCE TYPE DARLINGTON TRANSISTOR ARRAY

Grounded Emitter Transfer Characteristics

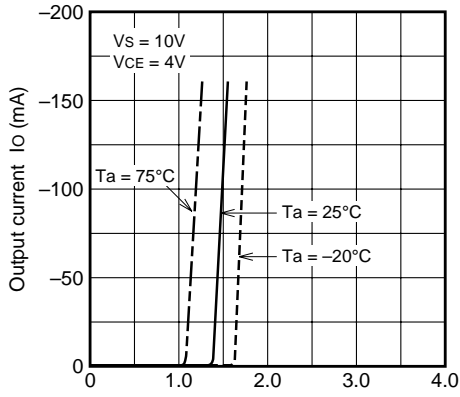

Supply voltage-Input voltage  $V_s - V_i$  (V)

DC Amplification Factor Output Current Characteristics

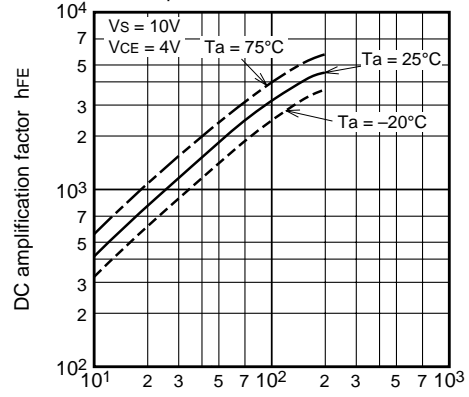

Output current  $I_o$  (mA)

Input Characteristics

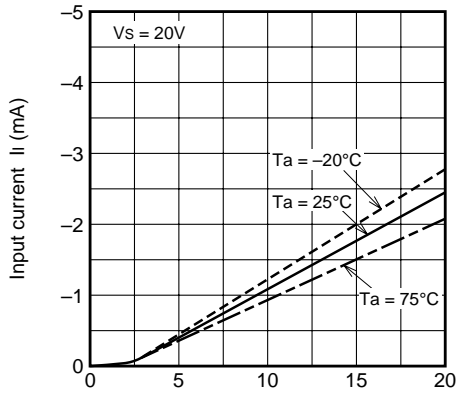

Supply voltage-Input voltage  $V_s - V_i$  (V)