

MITSUBISHI HIGH-FREQUENCY RECTIFIER DIODES

FD1500AV-90

HIGH POWER, HIGH FREQUENCY,
PRESS PACK TYPE

FD1500AV-90



- IF(AV) Average forward current 1500A
- VRRM Repetitive peak reverse voltage 3500 ~ 4500V
- QRR Reverse recovery charge 2000μC
- Press pack type

OUTLINE DRAWING

Dimensions in mm

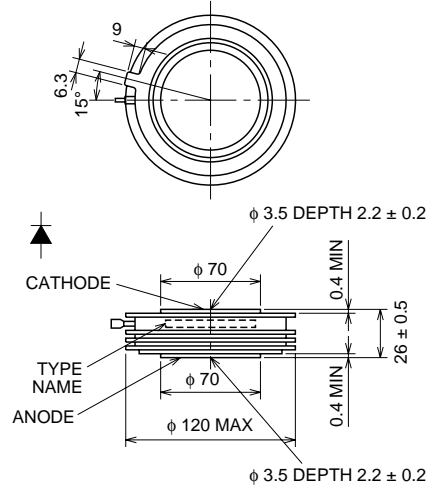

APPLICATION

High-power inverters, Fly-wheel diodes in DC choppers, Power supplies as high frequency rectifiers

MAXIMUM RATINGS

Symbol	Parameter	Voltage class			Unit
		70	80	90	
VRRM	Repetitive peak reverse voltage	3500	4000	4500	V
VRSM	Non-repetitive peak reverse voltage	3500	4000	4500	V
VR(DC)	DC reverse voltage	2800	3200	3600	V

Symbol	Parameter	Conditions	Ratings	Unit
IF(RMS)	RMS forward current		2350	A
IF(AV)	Average forward current	f = 60Hz, sine wave $\theta = 180^\circ$, $T_j = 65^\circ\text{C}$	1500	A
IFSM	Surge forward current	One half cycle at 60Hz, non-repetitive	24	kA
I^2t	Current-squared, time integration	One cycle at 60Hz	2.4×10^6	A ² s
T_j	Junction temperature		-40 ~ +125	°C
T_{stg}	Storage temperature		-40 ~ +150	°C
—	Mounting force required	Recommended value 49	44.1 ~ 58.8	kN
—	Weight	Standard value	1270	g

ELECTRICAL CHARACTERISTICS

Symbol	Parameter	Test conditions	Limits			Unit
			Min	Typ	Max	
IRRM	Repetitive peak reverse current	$T_j = 125^\circ\text{C}$, VRRM Applied	—	—	150	mA
VFM	Forward voltage	$T_j = 125^\circ\text{C}$, IFM = 3400A, Instantaneous measurement	—	—	3.0	V
QRR	Reverse recovery charge	IFM = 1200A, diF/dt = -30A/μs, VR = 150V, $T_j = 125^\circ\text{C}$	—	—	2000	μC
Rth(j-f)	Thermal resistance	Junction to fin	—	—	0.013	°C/W

Aug.1998

FD1500AV-90

HIGH POWER, HIGH FREQUENCY,
PRESS PACK TYPE

PERFORMANCE CURVES

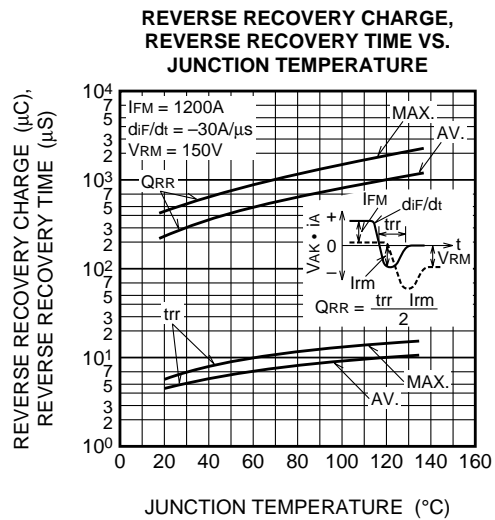
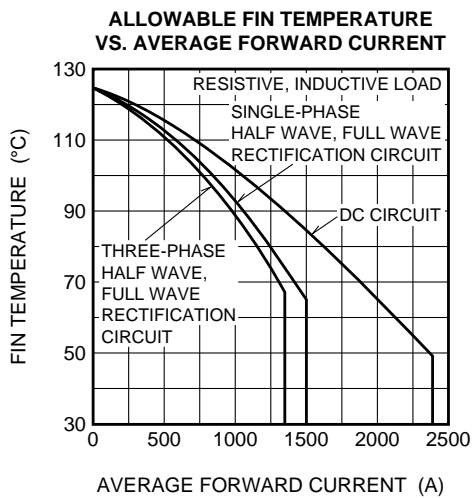
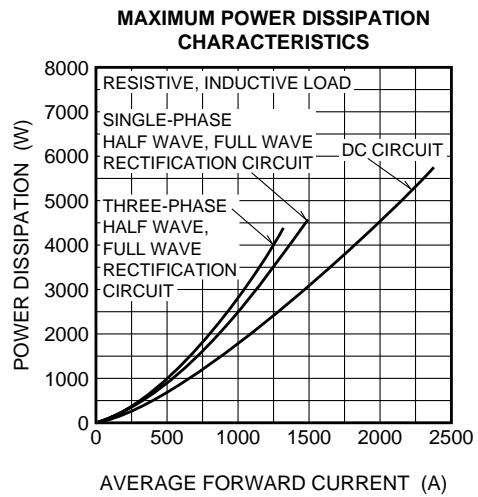
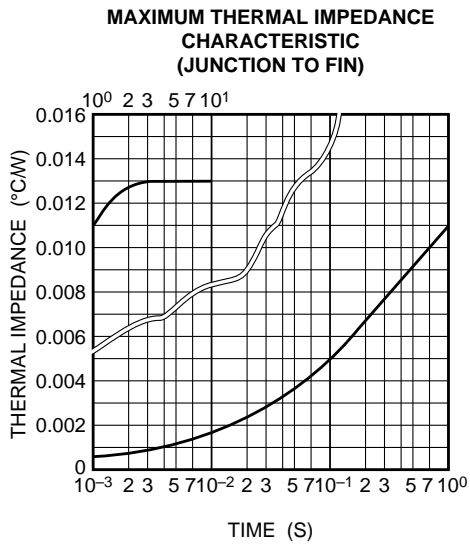
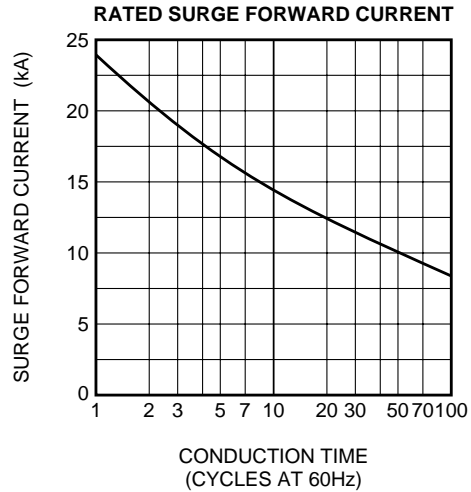
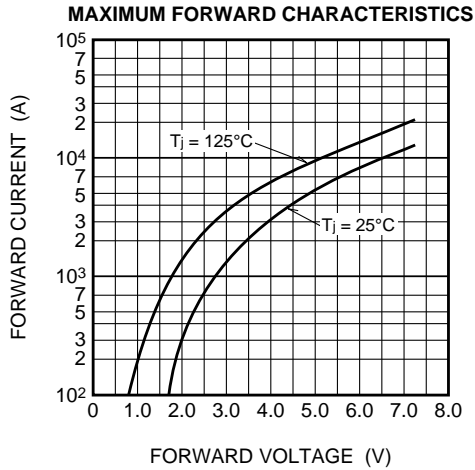

FD1500AV-90

HIGH POWER, HIGH FREQUENCY,
PRESS PACK TYPE

**REVERSE RECOVERY CHARGE,
REVERSE RECOVERY TIME VS.
FORWARD CURRENT**

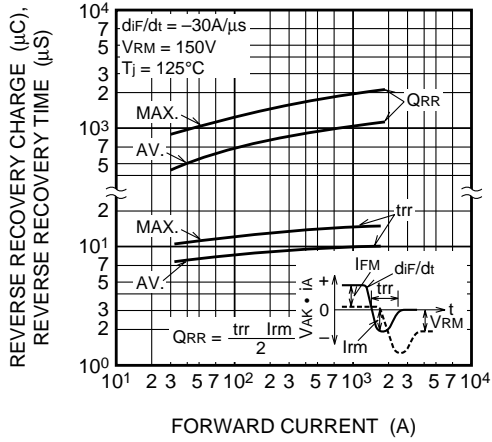

**REVERSE RECOVERY CHARGE,
REVERSE RECOVERY TIME VS. RATE
OF DECREASE OF REVERSE CURRENT**

