

THAT 2002N, 2002T, 2002R

FEATURES

- Wide Dynamic Range: >130 dB
- Wide Gain Range: > 130 dB
- Logarithmic Gain Control
- Very Low Distortion: (0.004% @0 dB gain, 0.01% @20dB gain)
- Temperature Compensated (2002T)
- Package Compatible with dbx 202

APPLICATIONS

- Faders
- Console Automation
- Panners
- Compressors
- Expanders
- Filters
- Oscillators

Description

The **THAT 2002N, 2002T and 2002R** modular voltage-controlled amplifiers (VCAs) represent the highest state of the current VCA art. They are extremely high performance current-in/ current-out devices with negative-sense control ports. Intended for the most demanding of applications, these parts require almost no external support circuitry and are packaged in small, 1" X 2"X0.5" modules. Their pin configurations are identical to that of the original dbx 202 VCA, as well as later dbx models 202C, 202X, 202XL and 2001, and THAT models 202XT, 202XTC and 202R.

The **2002T** has a control constant of -20dB/Volt , and is internally temperature compensated for very low thermal drift. The **2002T** is recommended for all new designs. The **2002N** is intended to replace earlier dbx or THAT models in designs where control-voltage temperature compensation was provided externally. Like most dbx and THAT modular VCAs, the **2002N** has a control constant of -20dB/Volt , with a predictable $+0.33\%/^{\circ}\text{C}$ temperature drift. The **2002R** is intended to replace the original dbx 202. The **2002R** matches the dbx 202's control sensitivity of -6mV/dB and its predictable $+0.33\%/^{\circ}\text{C}$ temperature drift.

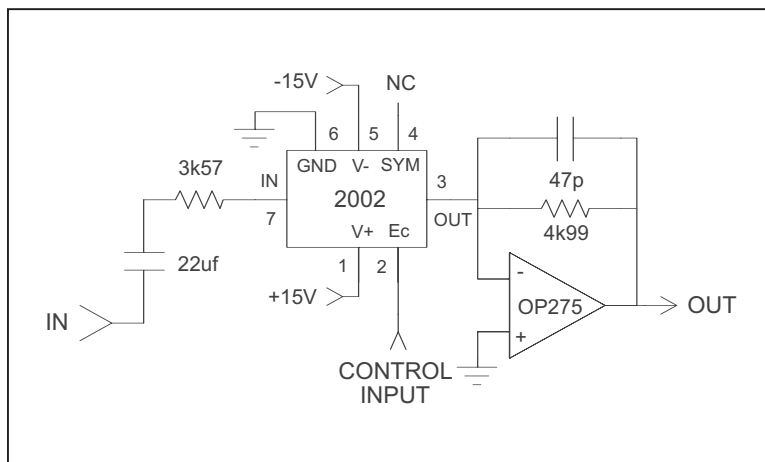

Figure 1. 2002 Typical Application Circuit

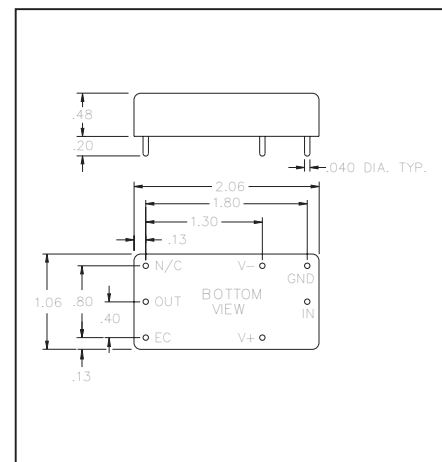

Figure 2. 2002 Physical Outline

SPECIFICATIONS¹

<u>Absolute-Maximum Ratings ($T_A = 25^\circ\text{C}$)</u>			
Positive Supply Voltage (V_{CC})	+20 V	Power Dissipation (P_D)	1 W
Negative Supply Voltage (V_{EE})	-20 V	Operating Temperature Range (T_{OP})	-20 to +60°C
Supply Current (I_{CC})	30 mA	Storage Temperature Range (T_{ST})	-40 to +125°C

<u>Recommended Operating Conditions</u>												
Parameter	Symbol	Conditions	<u>2002N</u>			<u>2002R</u>			<u>2002T</u>			Units
			Min	Typ	Max	Min	Typ	Max	Min	Typ	Max	
Positive Supply Voltage	V_{CC}		+12	+15	+18	12	+15	+18	+12	+15	+18	V
Negative Supply Voltage	V_{EE}		12	-15	-18	-12	-15	-18	-12	-15	-18	V
Signal Current		$V_{CC}=-V_{EE}=15\text{ V}$	—	1.4	6.0	—	1.4	6.0	—	1.4	6.0	mA

<u>Electrical Characteristics²</u>												
Parameter	Symbol	Conditions	<u>2002N</u>			<u>2002R</u>			<u>2002T</u>			Units
			Min	Typ	Max	Min	Typ	Max	Min	Typ	Max	
Supply Current	I_{CC}	No Signal	—	18	26	—	18	26	—	18	26	mA
Input Impedance	R_{IN}		1.37	1.4	1.43	1.37	1.4	1.43	1.37	1.4	1.43	k Ω
Equiv. Input Bias Current	I_B	No Signal	—	8	60	—	8	60	—	8	60	nA
Input Offset Voltage	$V_{OFF(IN)}$	No Signal	—	± 5	—	—	± 5	—	—	± 5	—	mV
Output Offset Voltage	$V_{OFF(OUT)}$	$R_{out}=4.99\text{ k}\Omega$										
		-100 dB < gain < 0 dB	—	1	2	—	1	2	—	1	2	mV
		+20 dB gain	—	5	10	—	5	10	—	5	10	mV
Gain-Control Constant	dB gain/ E_C	$T_A=27^\circ\text{C}$										
		-100 dB < gain < +40 dB	19.3	20	20.7	161.0	166.7	172.6	19.3	20	20.7	dB/V
Gain-control TempCo	$\Delta\text{Gain}/\Delta T_A$	$0^\circ\text{C} < T_A < 70^\circ\text{C}$										
		E_C constant	—	-0.33	—	—	-0.33	—	-0.04	0.0	+0.04	%/°C
Gain-Control Linearity		-60 to +40 dB gain	—	0.5	2	—	0.5	2	—	0.5	2	%
Off Isolation		$E_C = -6\text{V}$	110	115	—	—	—	—	110	115	—	dB
		$E_C = -.72\text{V}$	—	—	—	110	115	—	—	—	—	dB
Output Noise	$e_{n(OUT)}$	20Hz-20kHz, $R_{out} = 4.99\text{ k}\Omega$										
		0 dB gain	—	-104	-102	—	-104	-102	—	-104	-102	dBV
		+20 dB gain	—	-89	-87	—	-89	-87	—	-89	-87	dBV
Total Harmonic Distortion	THD	1kHz										
		0 dB gain, 0 dBV out	—	0.004	—	—	0.004	—	—	0.004	—	%
		0 dB gain, +10 dBV out	—	0.006	0.01	—	0.006	0.01	—	0.006	0.01	%
		+20 dB gain, +10 dBV out	—	0.01	0.03	—	0.01	0.03	—	0.01	0.03	%
		-20 dB gain, +10 dBV in	—	0.01	0.03	—	0.01	0.03	—	0.01	0.03	%
Control Port Impedance	R_c	$T_a = 25^\circ\text{C}$	806	815	823	198	200	202	786	832	881	Ω

1. All specifications subject to change without notice.

2. Unless otherwise noted, $T_A=25^\circ\text{C}$, $V_{CC} = +15\text{V}$, $V_{EE} = -15\text{V}$. Test circuit is as shown in Figure 1.

Representative Performance Curves²

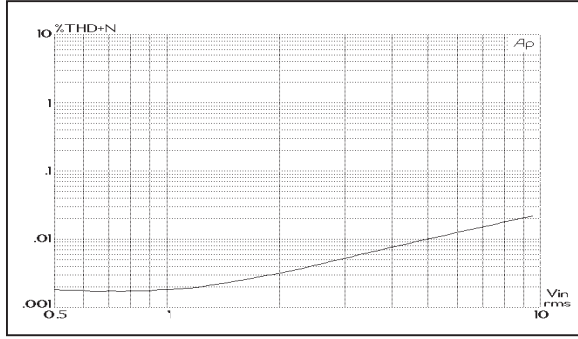

Figure 3. 1kHz THD+Noise vs. Input Level, 0 dB Gain

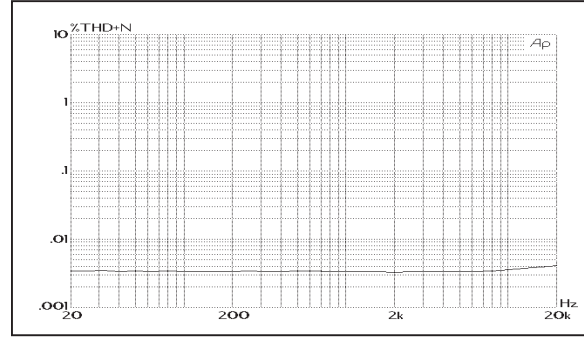

Figure 7. THD+Noise vs. Frequency, 0dB Gain, +10dBV In

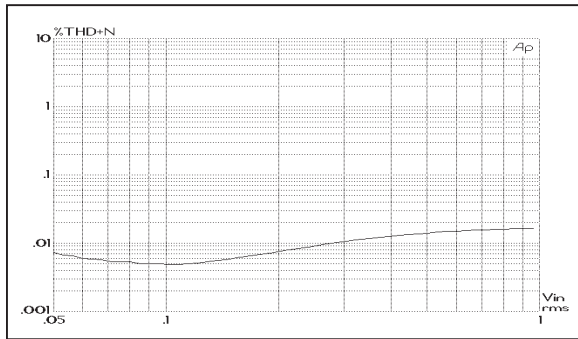

Figure 4. 1kHz THD+Noise vs. Input Level, +20 dB Gain

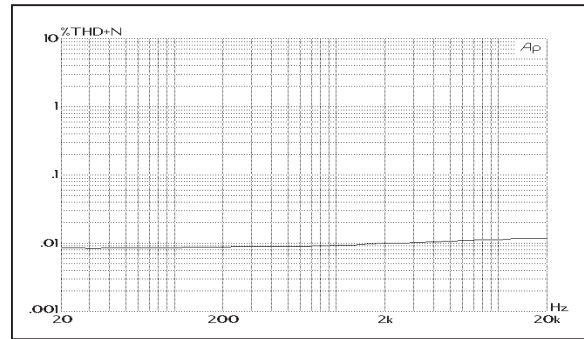

Figure 8. THD+Noise vs. Frequency, +20dB Gain, -10dBV In

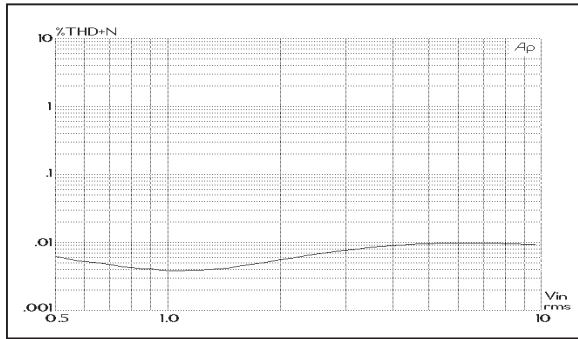

Figure 5. 1kHz THD+Noise vs. Input Level, -20 dB Gain

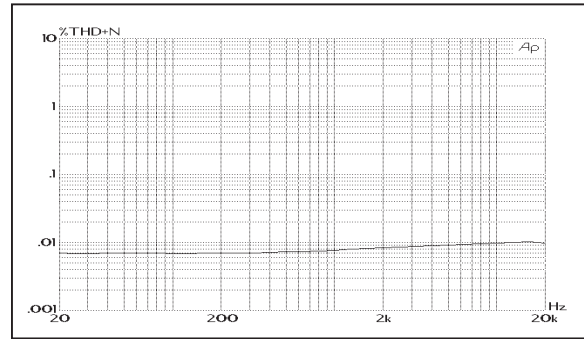

Figure 9. THD+Noise vs. Frequency, -20dB Gain, +10dBV In

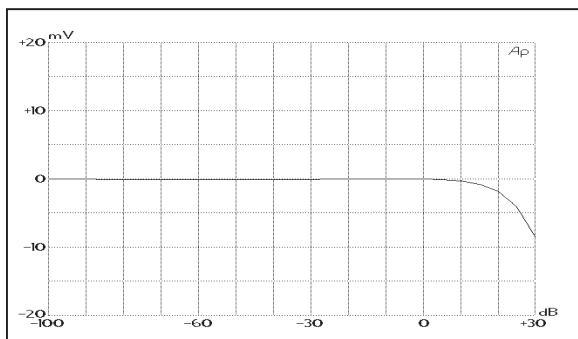

Figure 6. Representative DC Offset vs. Gain

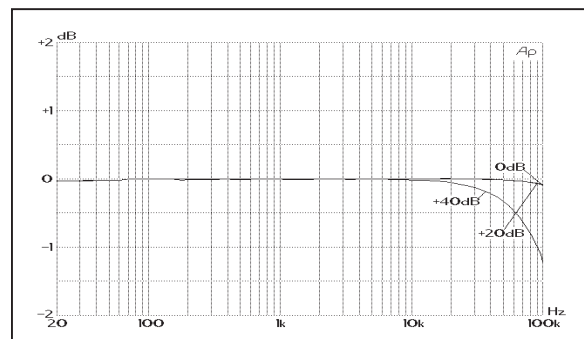

Figure 10. Frequency Response at Various Gains

Representative Performance Curves² Cont'd

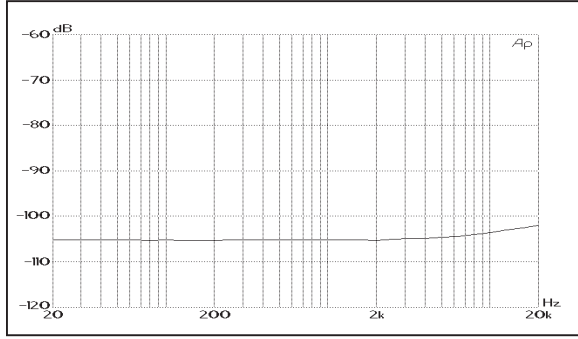

Figure 11. Off Isolation vs. Frequency, -105dB Gain

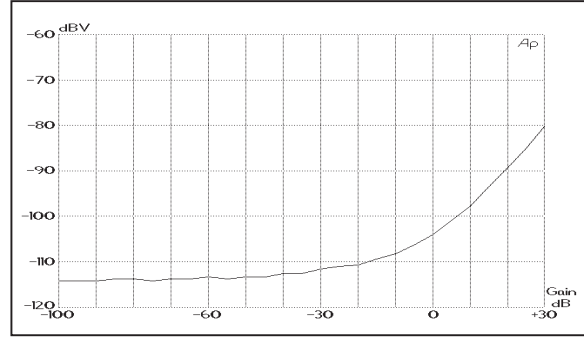

Figure 13. Output Noise vs. Gain (20Hz~20kHz Unweighted)

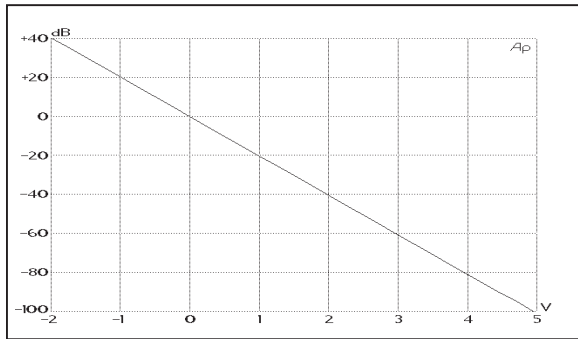

Figure 12. Gain vs. Control Voltage