

Features

- Low Noise Figure: 1.6 dB
- High Input IP3: -6 dBm at 3 V, 6.5 mA bias
- High Gain: 18 dB
- Single Supply: +3 to +8 VDC
- Adjustable current: 3 to 20 mA with external resistor
- Lead-Free SOT-26 Plastic Package
- 100% Matte Tin Plating over Copper
- Halogen-Free "Green" Mold Compound
- 260°C Reflow Compatible
- RoHS* Compliant Version of AM50-0006

Description

M/A-COM's MAALSS0048 is a high dynamic range, GaAs MMIC, low noise amplifier in a lead-free, SOT-26 miniature surface mount, plastic package. It employs external input matching to obtain optimum noise figure performance and operating frequency flexibility.

The MAALSS0048 also features flexible biasing to control the current consumption vs. dynamic range trade-off. The MAALSS0048 can operate from any positive supply voltage in the 3 V to 8 V range. Its current can be controlled over a range of 3 mA to 20 mA with an external resistor.

The MAALSS0048 is ideally suited for use where low noise figure, high gain, high dynamic range, and low power consumption are required. Typical applications included receiver front ends in PDC, DCS-1800, DCS-1900 and other PCN/PCS applications. It is also useful as a gain block, buffer, driver, and IF amplifier in both fixed or portable PDC and PCN/PCS systems.

The MAALSS0048 is fabricated using a low-cost 0.5-micron gate length GaAs process. The process features full passivation for increased performance and reliability. The MAALSS0048 is 100% RF tested to ensure performance specification compliance.

Functional Block Diagram

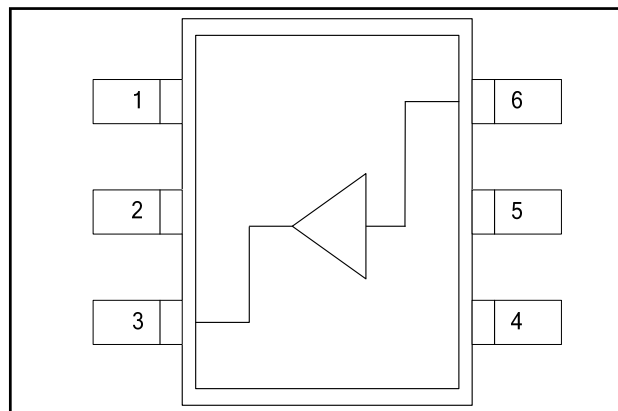

Pin Configuration

Pin No.	Pin Name	Description
1	V _{DD}	Positive supply voltage
2	GND	RF and DC Ground
3	RF Output	RF Output of the amplifier
4	GND	RF and DC Ground
5	R _{EXT} C _{EXT}	External Current Control By-Pass Capacitor
6	RF Input	RF Input of the amplifier

Ordering Information ^{1,2}

Part Number	Package
MAALSS0048	SOT-26 Plastic Package
MAALSS0048TR-3000	3000 piece reel
MAALSS0048PDC	1400-1520 MHz Designer's Kit
MAALSS0048PCS	1700-2000 MHz Designer's Kit

1. Reference Application Note M513 for reel size information.
2. All sample boards include 5 loose parts.

* Restrictions on Hazardous Substances, European Union Directive 2002/95/EC.

Low Noise Amplifier 1400 - 2000 MHz

Rev. V2

Electrical Specifications³: $T_A = +25^\circ\text{C}$, $Z_0 = 50 \Omega$, $P_{in} = -30 \text{ dBm}$

Parameter	Test Conditions	Units	1500 MHz			1900 MHz		
			Min.	Typ.	Max.	Min.	Typ.	Max.
Gain	$V_{DD} = 3 \text{ Volts}$	dB	15	18	20	15	17.5	20
Noise Figure	$V_{DD} = 3 \text{ Volts}$	dB	—	1.60	2.00	—	1.65	2.00
Input VSWR	—	Ratio	—	2.2:1	—	—	1.5:1	—
Output VSWR	—	Ratio	—	1.5:1	—	—	1.5:1	—
Output 1 dB Compression	$V_{DD} = 3 \text{ Volts}$	dBm	—	1	—	—	0	—
Input IP3	$V_{DD} = 3 \text{ Volts}$	dBm	—	-5.0	—	—	-6.0	—
Reverse Isolation	—	dB	—	35	—	—	35	—
Drain Current	$V_{DD} = 3 \text{ Volts}$	mA	4.5	6.5	10	4.5	6.5	10

3. Using external 15 Ω resistor. See Functional Schematics.

Absolute Maximum Ratings^{4,5}

Parameter	Absolute Maximum
V_{DD}	+10 VDC
Input Power	+17 dBm
Current ⁶	30 mA
Channel Temperature ⁷	+150°C
Operating Temperature	-40°C to +85°C
Storage Temperature	-65°C to +150°C

- Exceeding any one or combination of these limits may cause permanent damage to this device.
- M/A-COM does not recommend sustained operation near these survivability limits.
- When pin #5 is used to increase current (see note 8).
- Thermal resistance (θ_{jc}) = +150°C/W

Handling Procedures

Please observe the following precautions to avoid damage:

Static Sensitivity

Gallium Arsenide Integrated Circuits are sensitive to electrostatic discharge (ESD) and can be damaged by static electricity. Proper ESD control techniques should be used when handling these devices.

Lead-Free SOT-26[†]

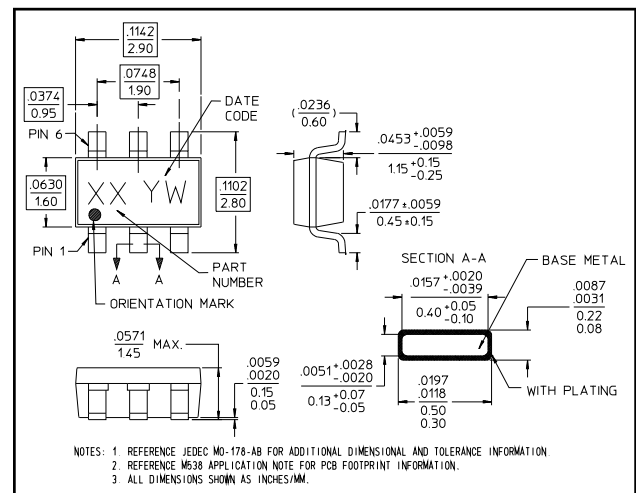

[†] Reference Application Note M538 for lead-free solder reflow recommendations.
Meets JEDEC moisture sensitivity level 1 requirements.

Data for 1700 - 2000 MHz Operation

Functional Schematic

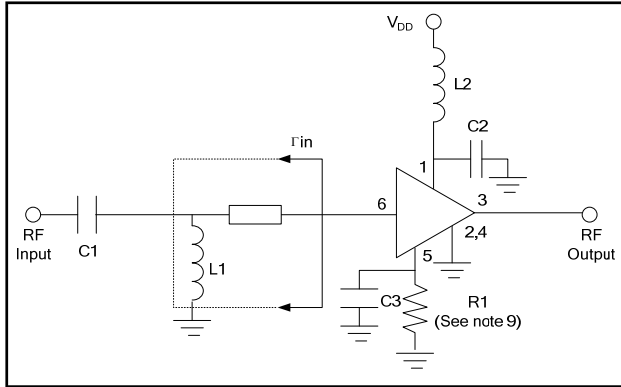

Input Reflection Coefficient

Frequency	1700 MHz	1850 MHz	2000 MHz
Γ_{in} (mag)	0.699	0.674	0.649
Γ_{in} (ang)	48.47°	38.68°	29.27°

External Circuitry Parts List ⁸

Part	Value	Purpose
C1	47 pF	DC Block
C2	470 pF	By-Pass
L1	2.7 nH	Tuning
L2	22 nH	RF Choke
R1	See note 9	Optional current control
C3	470 pF	By-Pass

Recommended PCB Configuration

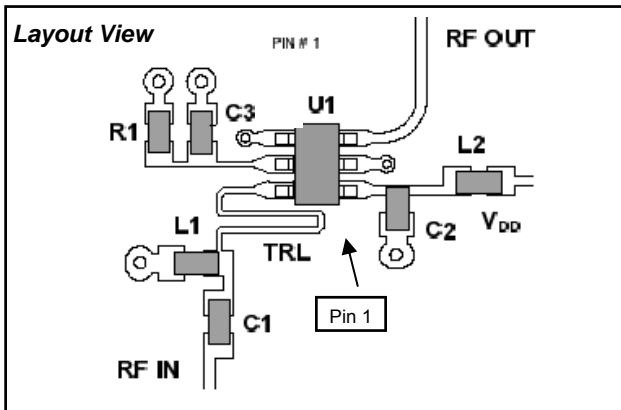

Cross Section View

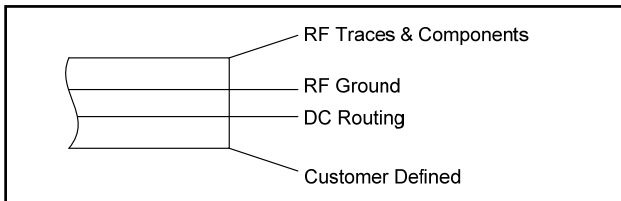

The PCB dielectric between RF traces and RF ground layers should be chosen to reduce RF discontinuities between 50 Ohm lines and package pins. M/A-COM recommends an FR-4 dielectric thickness of 0.008" (0.20 mm) yielding a 50 Ohm line width of 0.015" (0.38 mm). The recommended RF metalization thickness is 1 ounce copper.

- All external circuitry parts are readily available, low cost surface mount components (.060 in. x .030 in. or .080 in. x .050 in.)
- Pin 5 allows use of an external resistor to ground for optional, higher current.
For $I_{DD} \sim 5$ mA, $R1 = 150 \Omega$;
 $I_{DD} \sim 6.5$ mA, $R1 = 120 \Omega$;
 $I_{DD} \sim 20$ mA, $R1 = 27 \Omega$.

Typical Performance Curves, 1700 - 2000 MHz

Gain vs. Bias @ +25°C

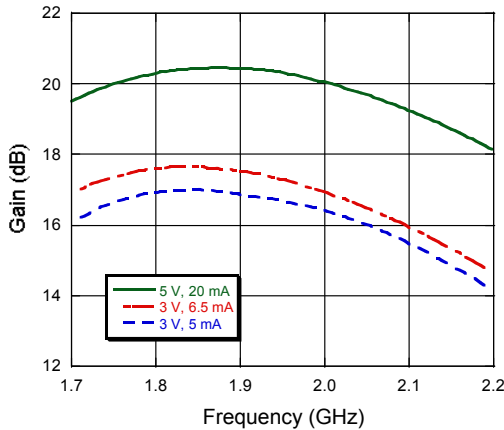

Input IP3 vs. Bias @ +25°C

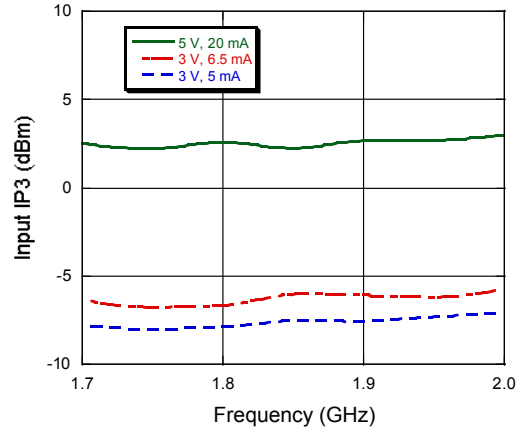

Noise Figure (Bias = 3V, 6.5 mA)

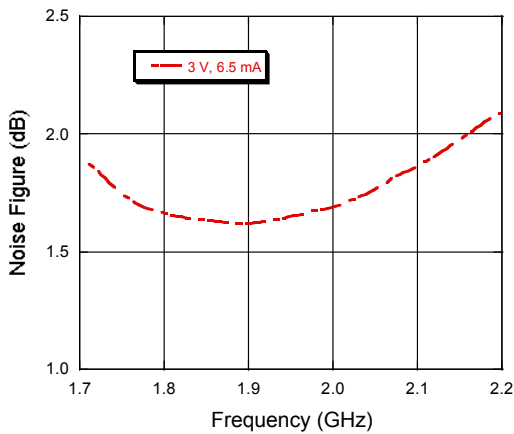

VSWR (Bias = 3V, 6.5 mA)

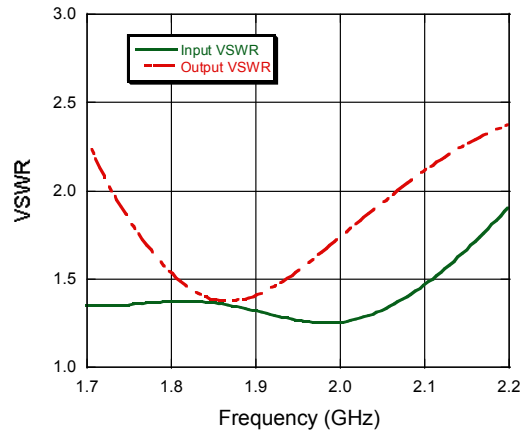

Output P1 dB vs. Bias @ +25°C

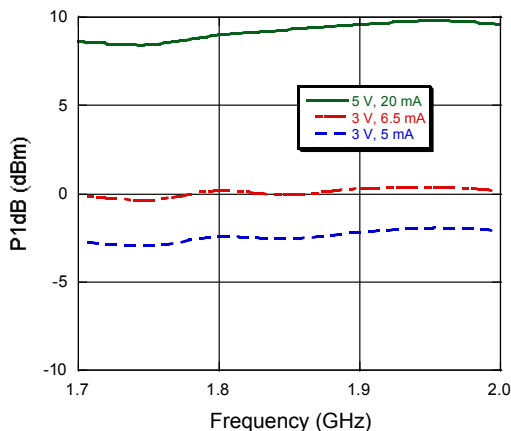

Input IP3 vs. Drain Current (Frequency = 1900 MHz)

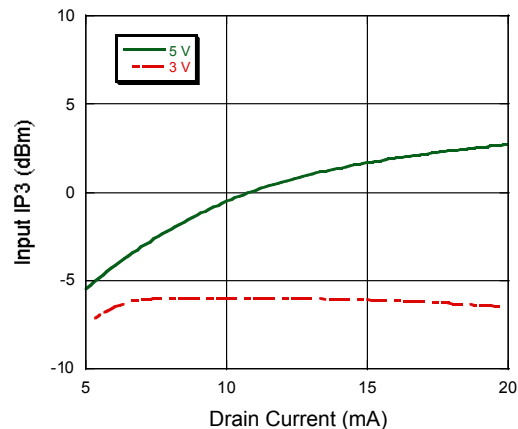

Typical Performance Curves, 1700 - 2000 MHz

Gain vs. Temperature (Bias = 3V, 6.5 mA)

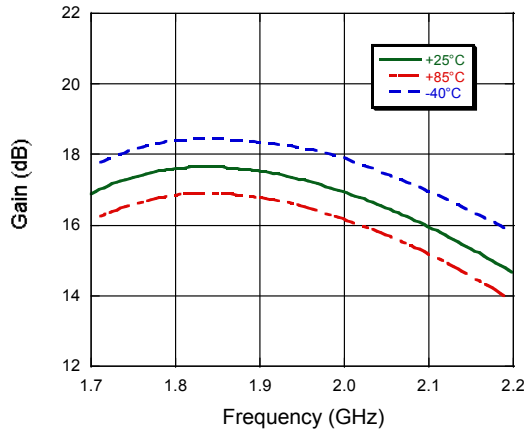

Noise Figure vs. Temperature (Bias = 3V, 6.5 mA)

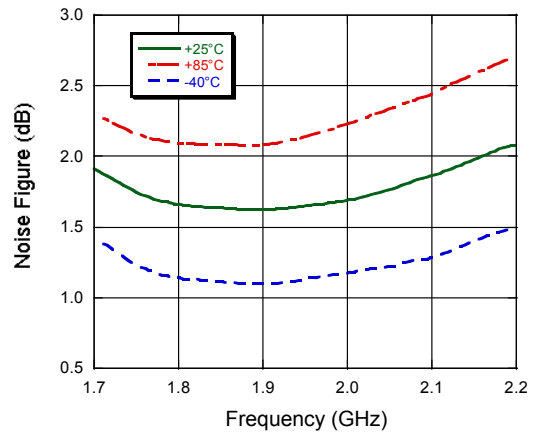

Data for 1400 - 1520 MHz Operation

Functional Schematic

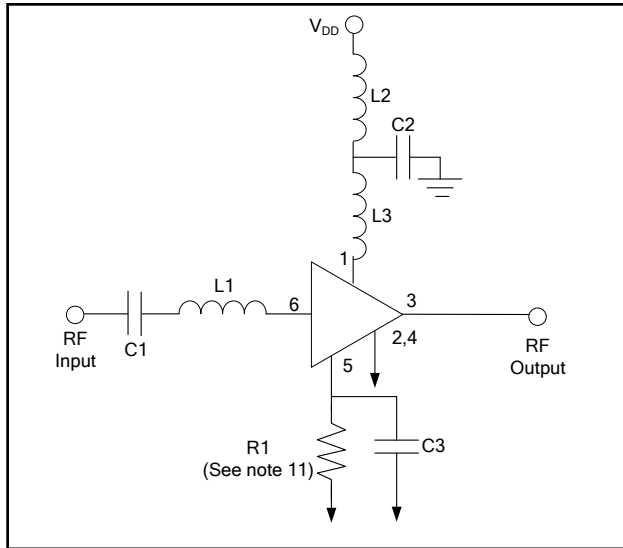

External Circuitry Parts List ¹⁰

Part	Value	Purpose
C1	47 pF	DC Block
C2	470 pF	By-Pass
L1	10 nH	Tuning
L2	3.9 nH	Tuning
L3	22 nH	RF Choke
R1	See note 11	Current control
C3	470 pF	By-Pass

10. All external circuitry parts are readily available, low cost surface mount components (.060 in. x .030 in. or .080 in. x .050 in.)
11. Pin 5 allows use of an external resistor to ground for optional, higher current.
 For $I_{DD} \sim 5$ mA, $R1 = 150 \Omega$;
 $I_{DD} \sim 6.5$ mA, $R1 = 120 \Omega$;
 $I_{DD} \sim 20$ mA, $R1 = 27 \Omega$.

Recommended PCB Configuration

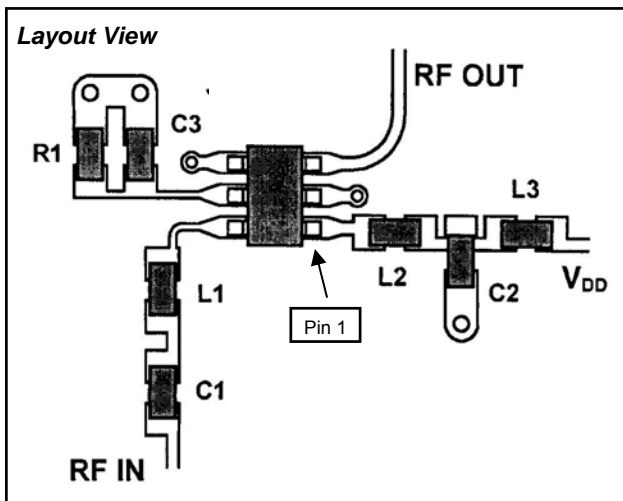

Cross Section View

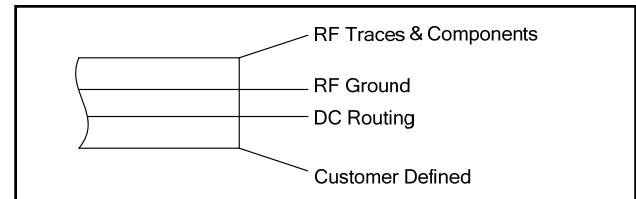

The PCB dielectric between RF traces and RF ground layers should be chosen to reduce RF discontinuities between 50 Ohm lines and package pins. M/A-COM recommends an FR-4 dielectric thickness of 0.008" (0.20 mm) yielding a 50 Ohm line width of 0.015" (0.38 mm). The recommended RF metalization thickness is 1 ounce copper.

Typical Performance Curves, 1400 - 1520 MHz

Gain vs. Bias @ +25°C

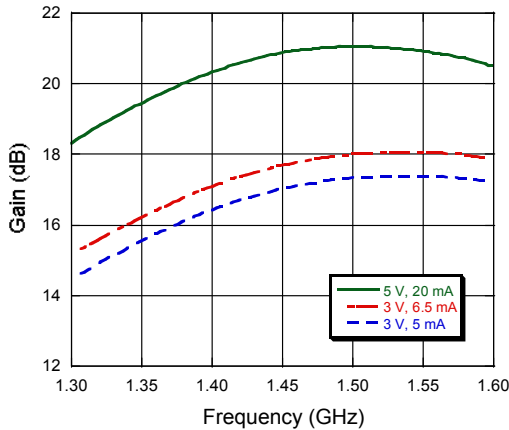

Input IP3 vs. Bias @ +25°C

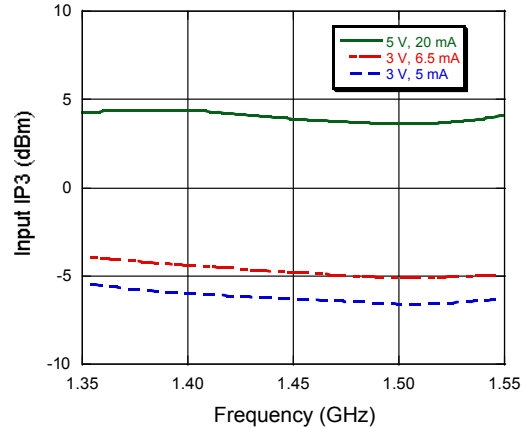

Noise Figure (Bias = 3V, 6.5 mA)

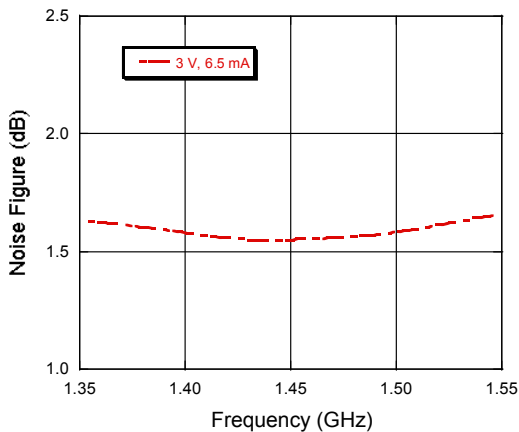

VSWR (Bias = 3V, 6.5 mA)

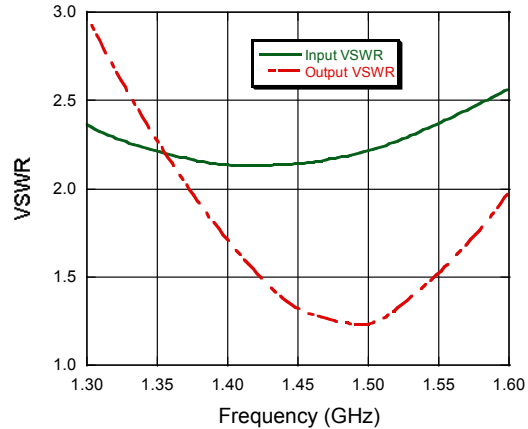

Output P1 dB vs. Bias @ +25°C

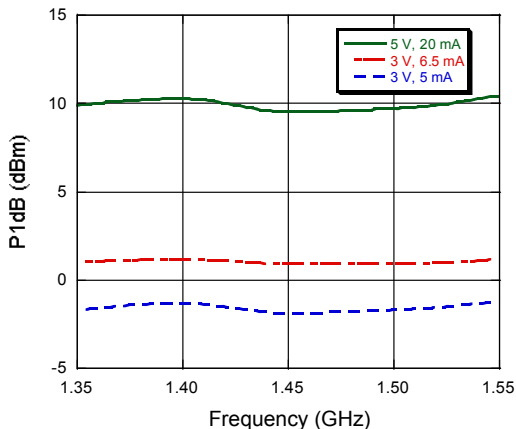

Input IP3 vs. Drain Current (Frequency = 1500 MHz)

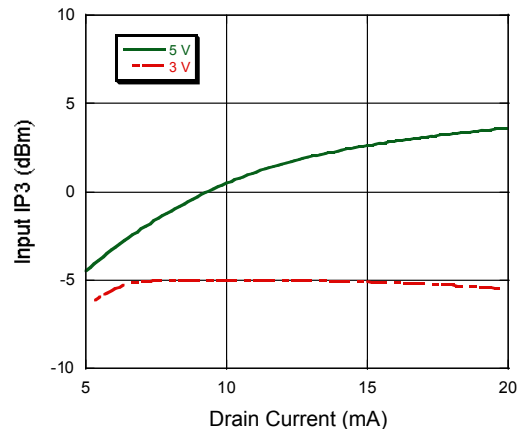

Typical Performance Curves, 1400 - 1520 MHz

Gain vs. Temperature (Bias = 3V, 6.5 mA)

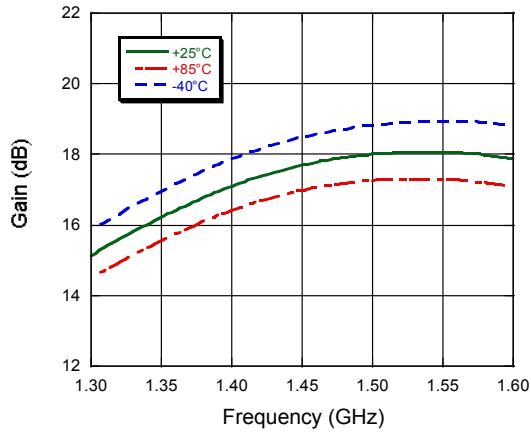

Noise Figure vs. Temperature (Bias = 3V, 6.5 mA)

