

Data Sheet

Features

- For wireless data applications
- Usable bandwidth of 1 MHz
- High attenuation
- Single-ended operation at 50Ω
- Ceramic Surface Mount Package (SMP)
- Small size

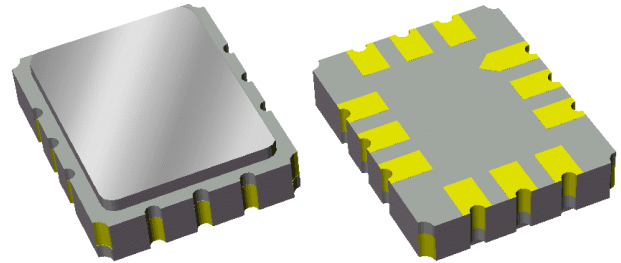

Package

Surface Mount 7.01 x 5.51 x 1.63 mm

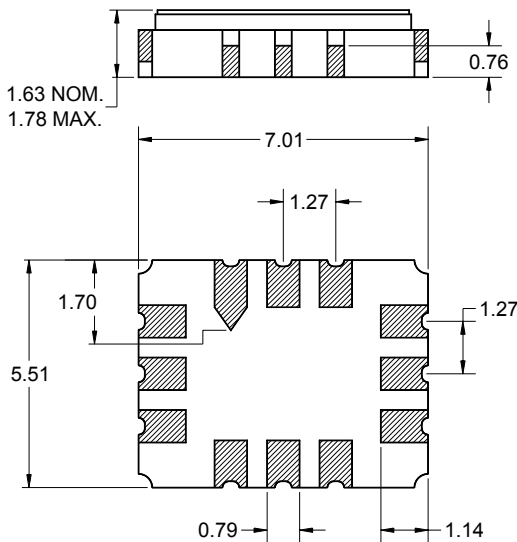

Pin Configuration

Bottom View

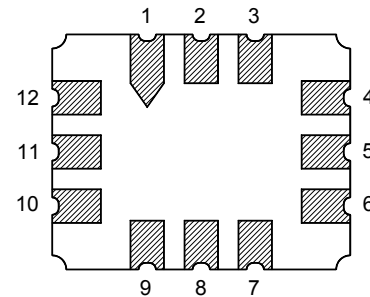

Pin No.	Description
4	Output
6	Output return
10	Input
12	Input return
1,2,3,5	Case Ground
7,8,9,11	Case Ground

Dimensions shown are nominal in millimeters
All tolerances are ± 0.15 mm except overall
length and width ± 0.13 mm

Body: Al_2O_3 ceramic
Lid: Kovar, Ni plated
Terminations: Au plating 0.5 - 1.0 μ m,
over a 2 - 6 μ m Ni plating

Data Sheet

Electrical Specifications ⁽¹⁾

Operating Temperature Range: ⁽²⁾ -10 to +60 °C

Parameter ⁽³⁾	Minimum	Typical	Maximum	Unit
Center Frequency	-	350	-	MHz
Insertion Loss at 350 MHz	-	8.2	10	dB
1 dB Bandwidth ⁽⁴⁾	1	1.57	-	MHz
3 dB Bandwidth ⁽⁴⁾	1.8	2.4	-	MHz
30 dB Bandwidth ⁽⁴⁾	-	4.76	5.1	MHz
40 dB Bandwidth ⁽⁴⁾	-	5.3	5.6	MHz
45 dB Bandwidth ⁽⁴⁾	-	5.6	15	MHz
Amplitude Variation 349.5 - 350.5 MHz	-	0.35	1	dB p-p
Group Delay Variation 349.5 - 350.5 MHz	-	72	200	nsec
Source Impedance ⁽⁵⁾	-	50	-	Ω
Load Impedance ⁽⁵⁾	-	50	-	Ω

Notes:

1. All specifications are based on the test circuit shown below
2. In production, devices will be tested at room temperature to a guardbanded specification to ensure electrical compliance over temperature
3. Electrical margin has been built into the design to account for the variations due to temperature drift and manufacturing tolerances
4. All attenuation measurements are measured relative to insertion loss at 350 MHz
5. This is the optimum impedance in order to achieve the performance shown

Test Circuit:

Actual matching values may vary due to PCB layout and parasitics

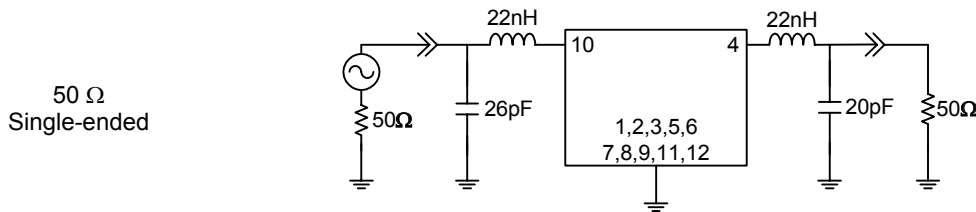

Data Sheet

Typical Performance (at +25°C)

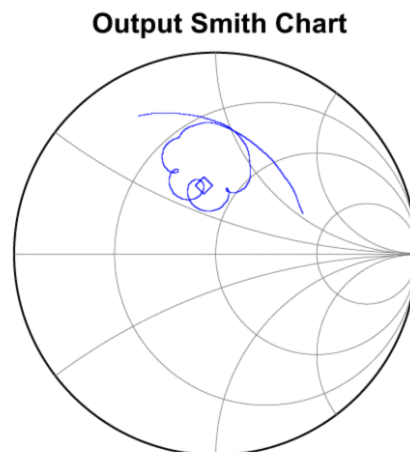
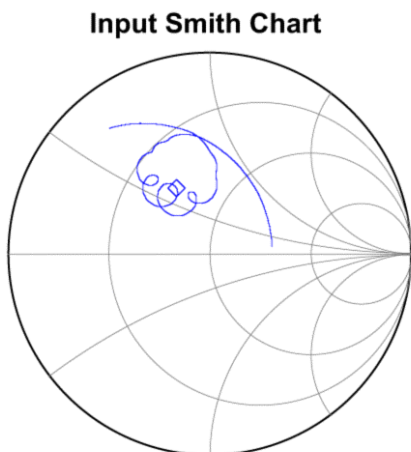
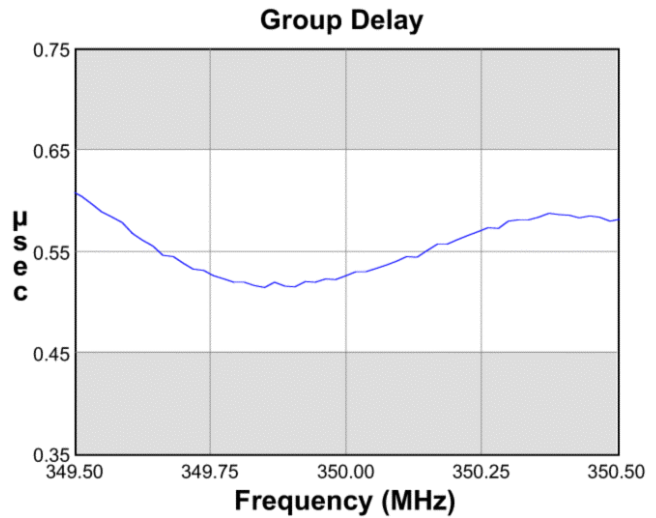
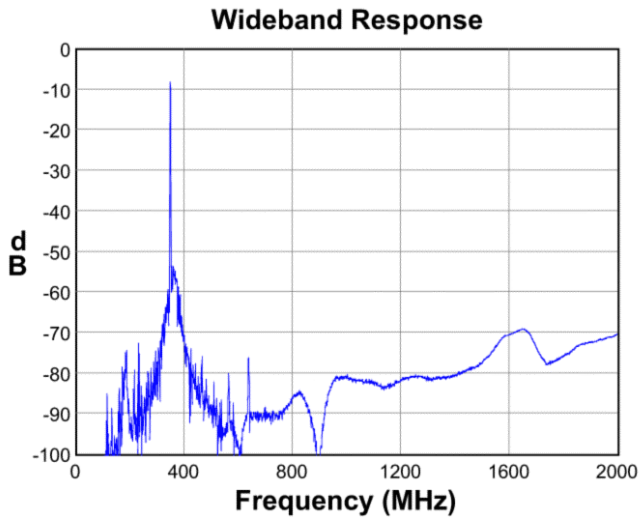
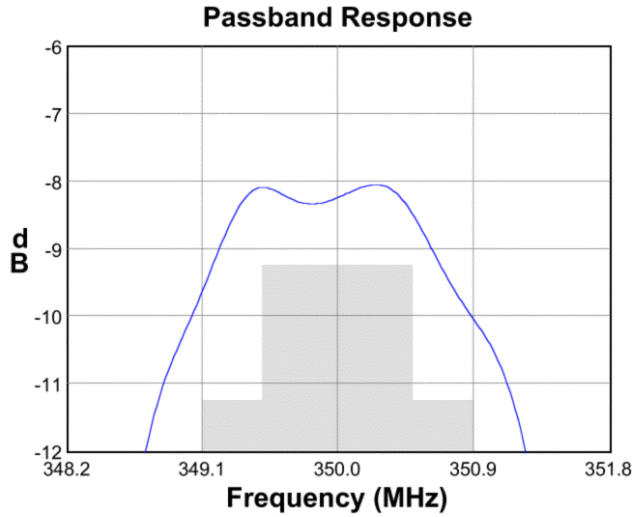
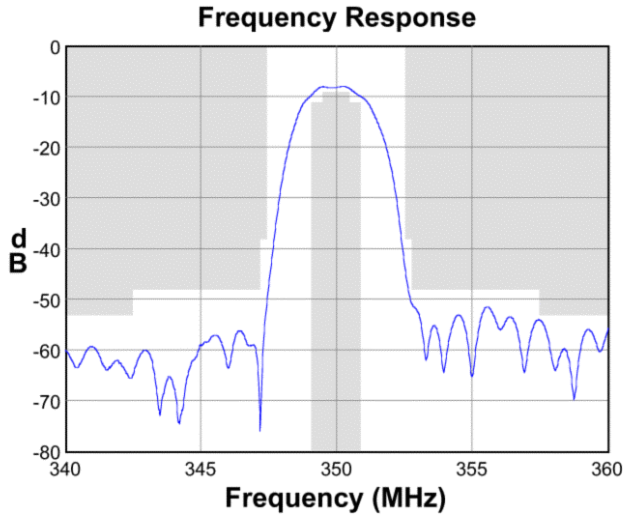

Data Sheet

Matching Schematics

Actual matching values may vary due to PCB layout and parasitics

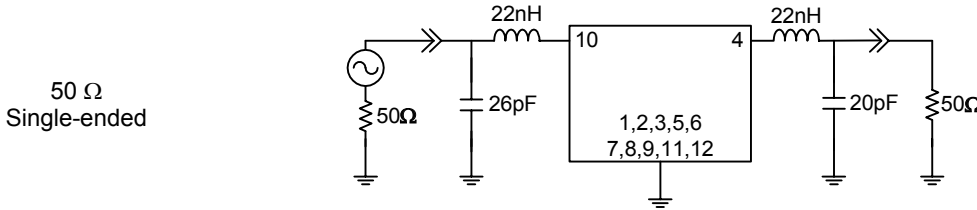

Marking



The date code consists of: day of the current year (Julian, 3 digits), last digit of the year (1 digit) and hour (2 digits)

PCB Footprint

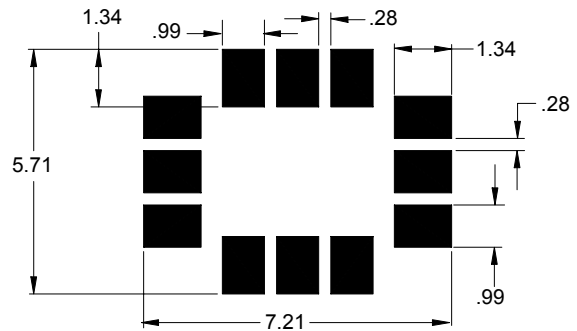

This footprint represents a recommendation only
Dimensions shown are nominal in millimeters

Tape and Reel

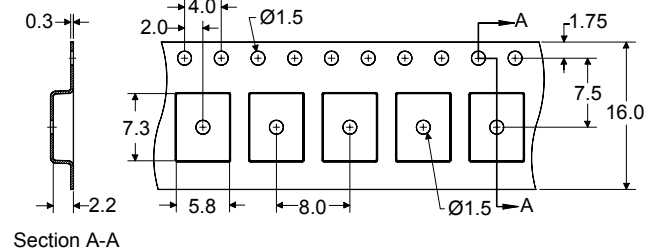
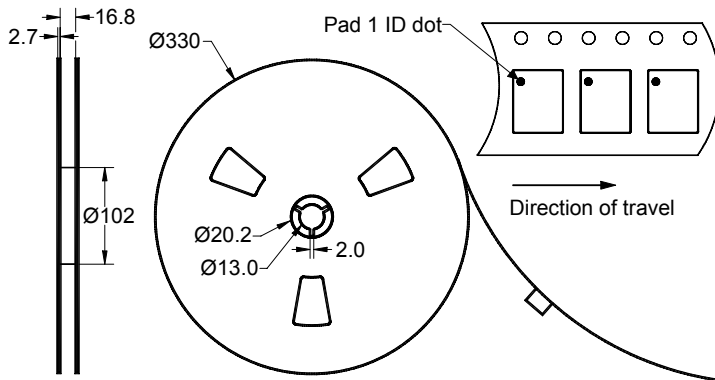

Dimensions shown are nominal in millimeters
Packaging quantity: 3000 units/reel

Data Sheet

Maximum Ratings

Parameter	Symbol	Minimum	Maximum	Unit
Operating Temperature Range	T	-10	+60	°C
Storage Temperature Range	T _{stg}	-40	+85	°C

Warnings

- Electrostatic Sensitive Device (ESD)
- Avoid ultrasonic exposure



Links to Additional Technical Information

[PCB Layout Tips](#)

[Qualification Flowchart](#)

[Soldering Profile](#)

[S-Parameters](#)

[Other Technical Information](#)

Contact Information



PO Box 609501
Orlando, FL 32860-9501
USA

Phone: +1 (407) 886-8860
Fax: +1 (407) 886-7061
Email: custservice@sawtek.com
Web: www.sawtek.com

Or contact one of our worldwide
network of [sales offices](#),
[representatives or distributors](#)