

WIDEBAND POWER AMPLIFIER MODULE, 0.01 - 15 GHz



Typical Applications

The HMC-C036 Wideband PA is ideal for:

- Telecom Infrastructure
- Microwave Radio & VSAT
- Military & Space
- Test Instrumentation
- Fiber Optics

Functional Diagram

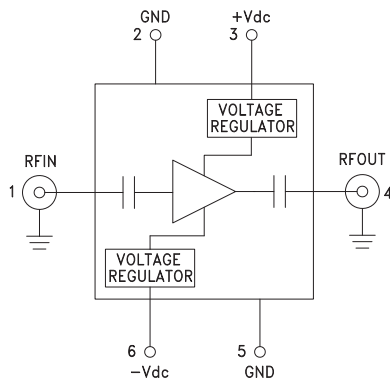

Features

- Gain: 12 dB
- P1dB Output Power: +28 dBm
- Regulated Supply and Bias Sequencing
- Hermetically Sealed Module
- Field Replaceable SMA connectors
- 0 °C to +85 °C Operating Temperature

General Description

The HMC-C036 is a GaAs MMIC PHEMT Power Amplifier in a miniature, hermetic module with replaceable SMA connectors which operates between 0.01 GHz and 15 GHz. The amplifier provides 12 dB of gain, up to +36 dBm output IP3 and up to +28 dBm of output power at 1 dB gain compression. Gain flatness is excellent from 2 - 12 GHz making the HMC-C036 ideal for EW, ECM RADAR, Fiber Optic and test equipment applications. The wideband amplifier I/Os are internally matched to 50 Ohms and are DC blocked. Integrated voltage regulators allow for flexible biasing of both the negative and positive supply pins, while internal bias sequencing circuitry assures robust operation.

Electrical Specifications, $T_A = +25^\circ \text{C}$, $+V_{dc} = +11\text{V to } +16\text{V}$, $-V_{dc} = -3\text{V to } -12\text{V}$

Parameter	Min.	Typ.	Max.	Min.	Typ.	Max.	Min.	Typ.	Max.	Units
Frequency Range	0.5 - 6.0			6.0 - 12.0			12.0 - 15.0			GHz
Gain	9.5	12.5		9	12		8	11		dB
Gain Flatness		±0.3			±0.3			±0.6		dB
Gain Variation Over Temperature		0.02			0.02			0.02		dB/ °C
Noise Figure		4.5			4.5			7.0		dB
Input Return Loss		22			11			4		dB
Output Return Loss		13			12			10		dB
Output Power for 1 dB Compression (P1dB)	25	28		23	26		23	26		dBm
Saturated Output Power (Psat)		29			27			28		dBm
Output Third Order Intercept (IP3)		36			34			32		dBm
Positive Supply Current (+IDC)		360			360			360		mA
Negative Supply Current (-IDC)		-5.5			-5.5			-5.5		mA

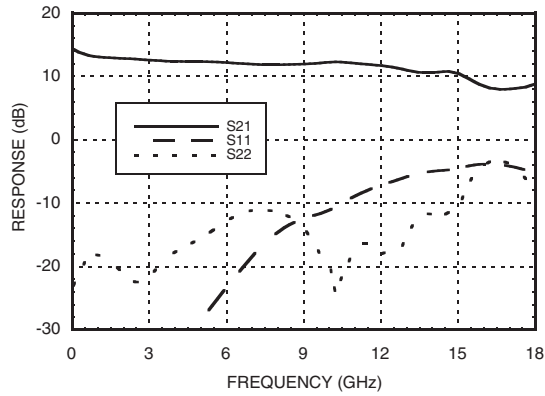
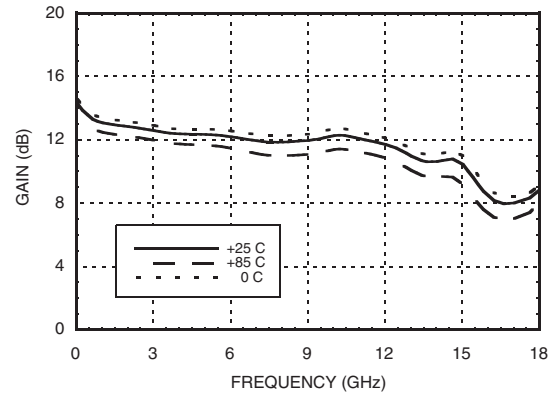
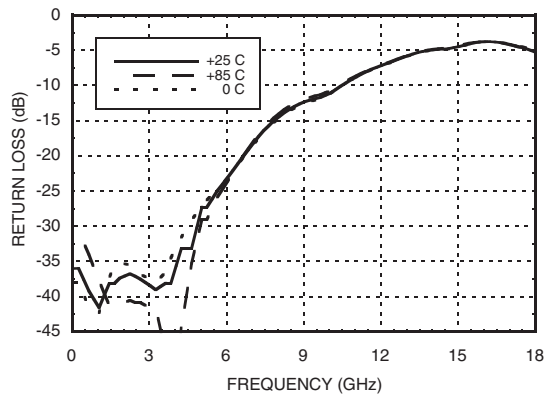
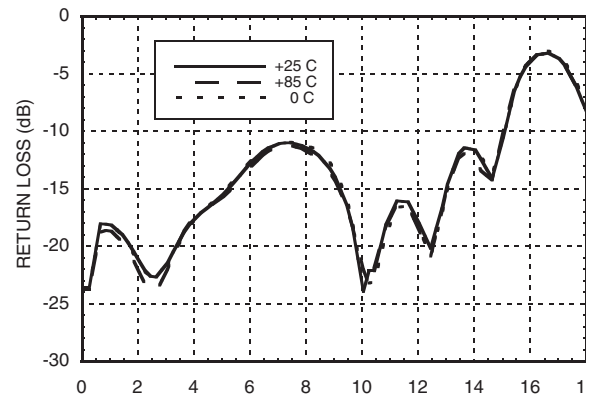
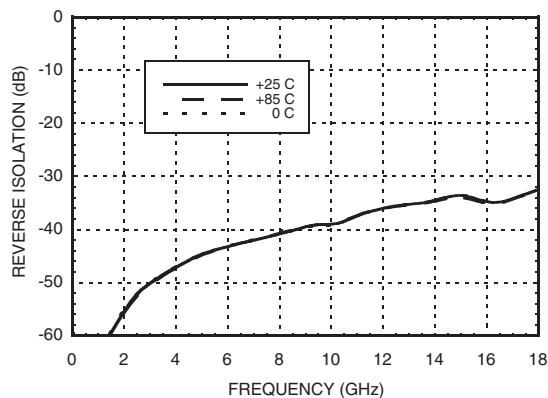
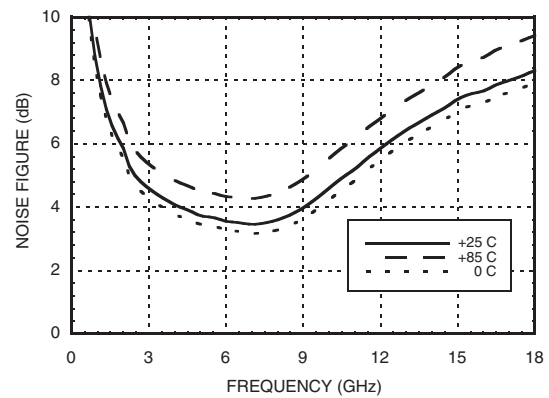
Gain & Return Loss

Gain vs. Temperature

Input Return Loss vs. Temperature

Output Return Loss vs. Temperature

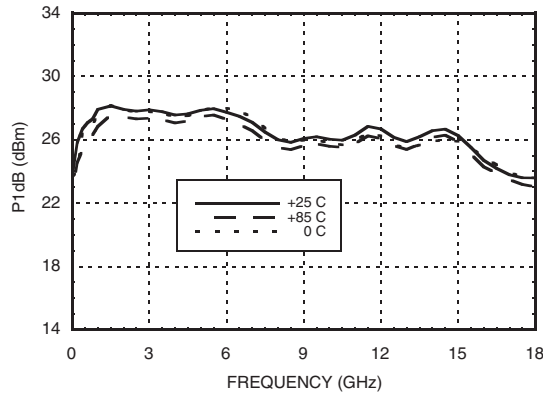
Reverse Isolation vs. Temperature

Noise Figure vs. Temperature



WIDEBAND POWER AMPLIFIER MODULE, 0.01 - 15 GHz

P1dB vs. Temperature



Psat vs. Temperature

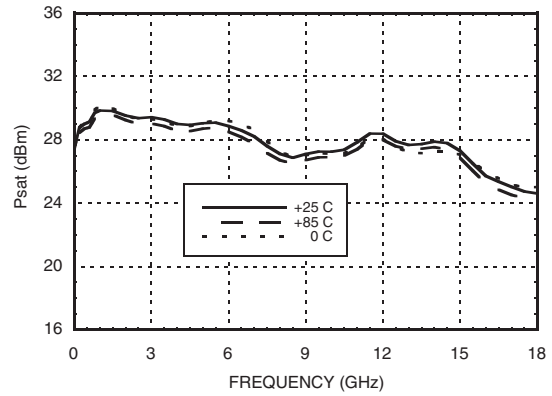

Output IP3 vs. Temperature

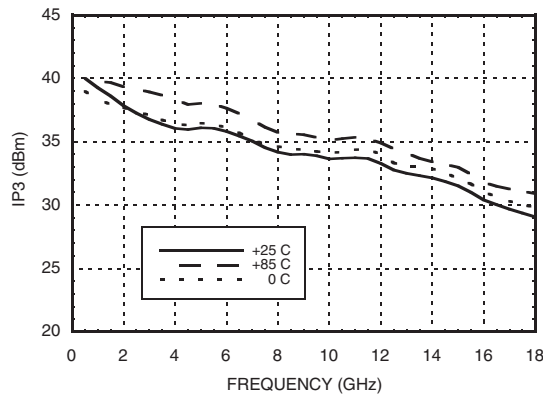

Group Delay

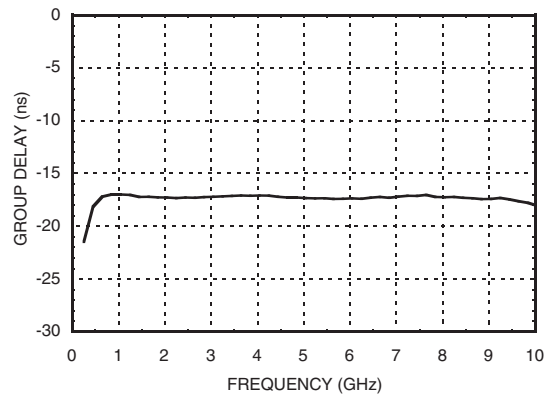

Deviation from Linear Phase

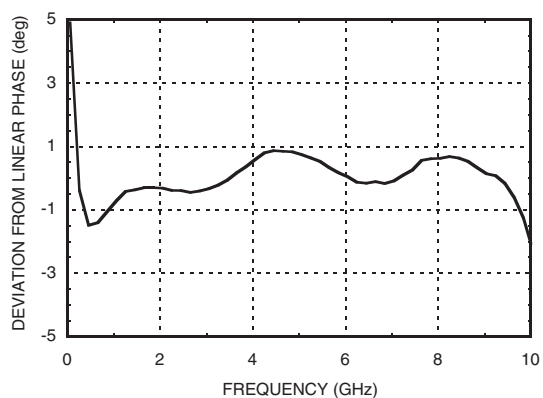

Low Frequency Gain & Return Loss

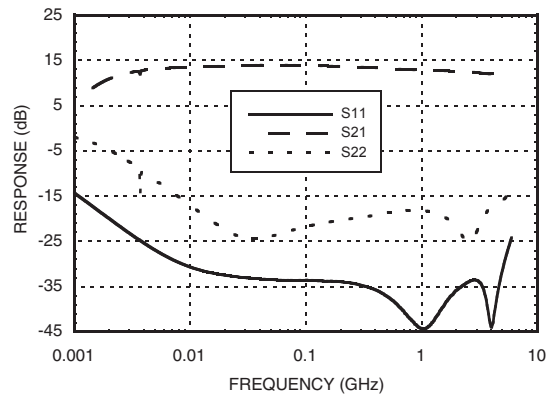



WIDEBAND POWER AMPLIFIER MODULE, 0.01 - 15 GHz



Absolute Maximum Ratings

Positive Bias Supply Voltage (+Vdc)	+17V Max
Negative Bias Supply (-Vdc)	-16V Min.
Maximum RF Input Power	
Peak	24 dBm
CW @ 0.01 - 6 GHz	22 dBm
CW @ 6 - 12 GHz	21 dBm
CW @ 12 - 20 GHz	18 dBm
Storage Temperature	-65 to +150 °C
Operating Temperature	0 to +85 °C

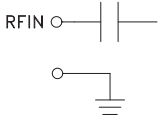

ELECTROSTATIC SENSITIVE DEVICE
OBSERVE HANDLING PRECAUTIONS

Pin Descriptions

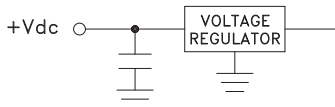
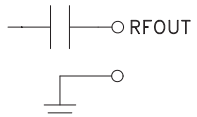
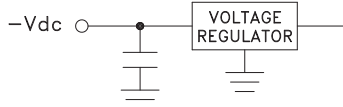
Pin Number	Function	Description	Interface Schematic
1	RFIN & RF Ground	RF input connector, SMA female, field replaceable. This pin is AC coupled and matched to 50 Ohms.	
2, 5	GND	Power supply ground.	
3	+Vdc	Positive power supply voltage for the amplifier.	
4	RFOUT & RF Ground	RF output connector, SMA female. This pin is AC coupled and matched to 50 Ohms.	
6	-Vdc	Negative power supply voltage for the amplifier	

WIDEBAND POWER AMPLIFIER MODULE, 0.01 - 15 GHz



Outline Drawing

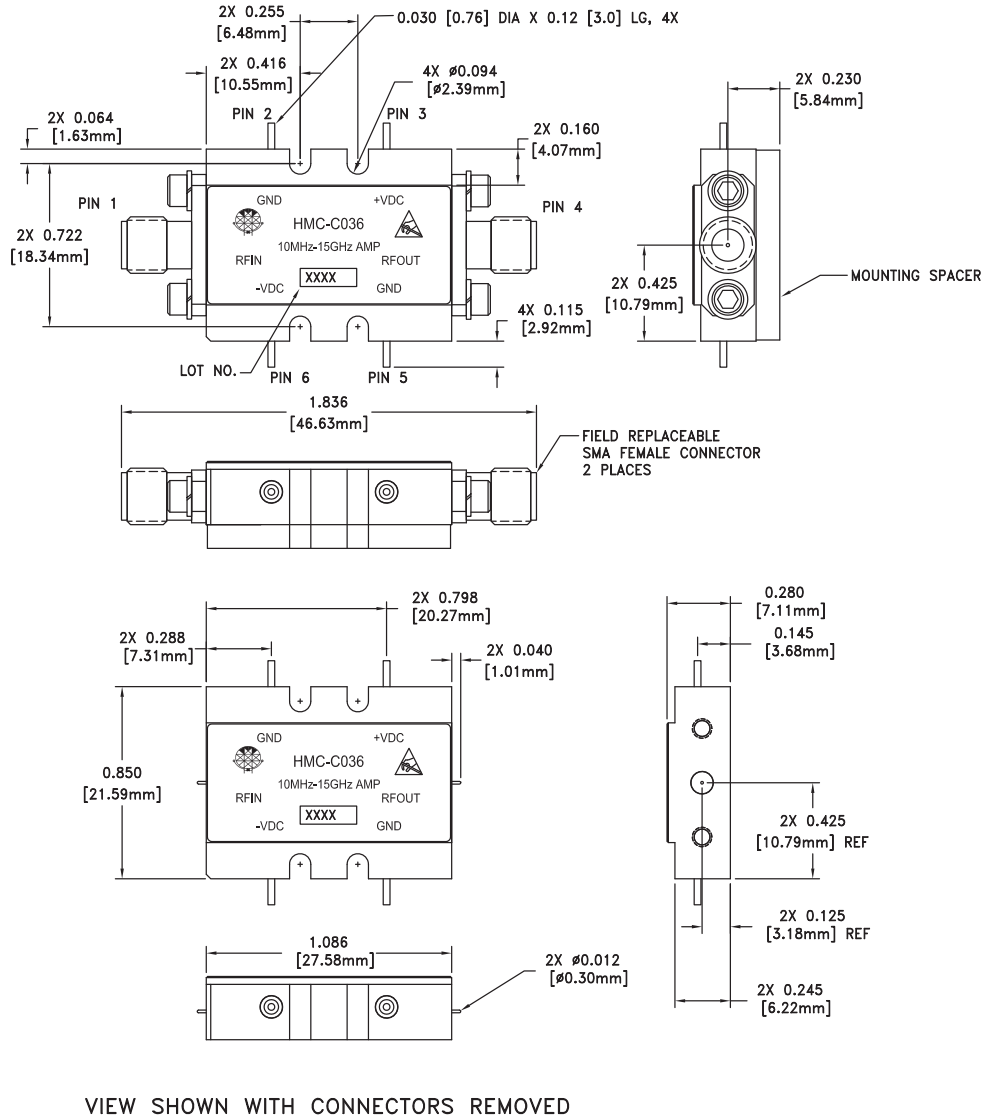

VIEW SHOWN WITH CONNECTORS REMOVED

Package Information

Package Type	C-10B
Package Weight [1]	23.1 gms [2]
Spacer Weight	N/A

[1] Includes the connectors

[2] ± 1 gms Tolerance

NOTES:

1. PACKAGE, LEADS, COVER MATERIAL: KOVAR™
2. FINISH: GOLD PLATE OVER NICKEL PLATE
3. ALL DIMENSIONS ARE IN INCHES [MILLIMETERS]
4. TOLERANCES:
 - 4.1 .XX = ± 0.02
 - 4.2 .XXX = ± 0.010
5. FIELD REPLACEABLE 2.92mm CONNECTORS TENSOLITE 231CCSF OR EQUIVALENT



MICROWAVE CORPORATION v04.0310



HMC-C036

**WIDEBAND POWER AMPLIFIER
MODULE, 0.01 - 15 GHz**

Notes: