



Typical Applications

The HMC-C017 Wideband LNA is ideal for:

- Telecom Infrastructure
- Microwave Radio & VSAT
- Military & Space
- Test Instrumentation
- Fiber Optics

Functional Diagram

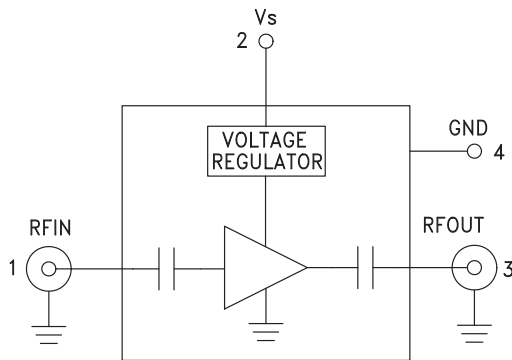

Features

Noise Figure: 2.75 dB

Gain: 18 dB

P1dB Output Power: +14 dBm

50 Ohm Matched Input/Output

Regulated Supply: $V_s = +8V$ to $+16V$

Hermetically Sealed Module

Field Replaceable 2.92 mm Connectors

-55 to $+85^\circ C$ Operating Temperature

General Description

The HMC-C017 is a GaAs MMIC PHEMT Low Noise Amplifier in a miniature, hermetic module which operates between 17 and 27 GHz. This high dynamic range amplifier module provides 18 dB of gain, 2.75 dB noise figure and up to +25 dBm of output IP3 while the internal voltage regulator accepts a supply voltage from +8V to +16V. The wideband amplifier I/Os are internally matched to 50 Ohms and are internally DC blocked for robust performance. The module features removable coaxial connectors which can be detached to allow direct connection of the I/O pins to a microstrip or coplanar circuit.

Electrical Specifications, $T_A = +25^\circ C$, $V_s = +8V$ to $+16V$

Parameter	Min.	Typ.	Max.	Min.	Typ.	Max.	Units
Frequency Range	17 - 22		22 - 27				GHz
Gain	16	19		14.5	17.5		dB
Gain Variation Over Temperature		0.015	0.025		0.015	0.025	dB/°C
Noise Figure		2.75	3.25		3.0	4.0	dB
Input Return Loss		14			14		dB
Output Return Loss		10			13		dB
Output Power for 1 dB Compression (P1dB)	10.5	13.5		12	15		dBm
Saturated Output Power (Psat)		18			18.5		dBm
Output Third Order Intercept (IP3)		24			26		dBm
Supply Current		96			96		mA



Gain & Return Loss

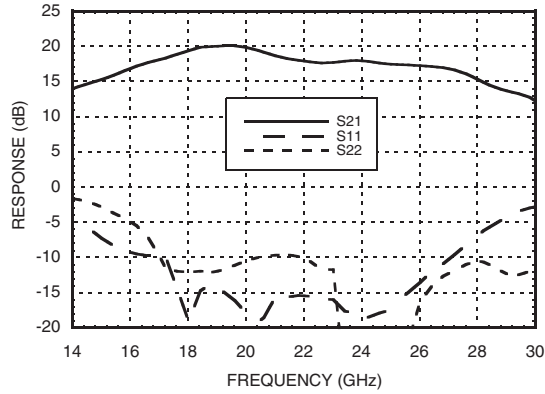

Gain vs. Temperature

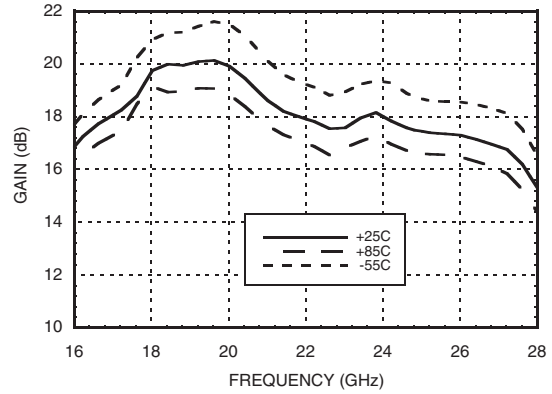

Input Return Loss vs. Temperature

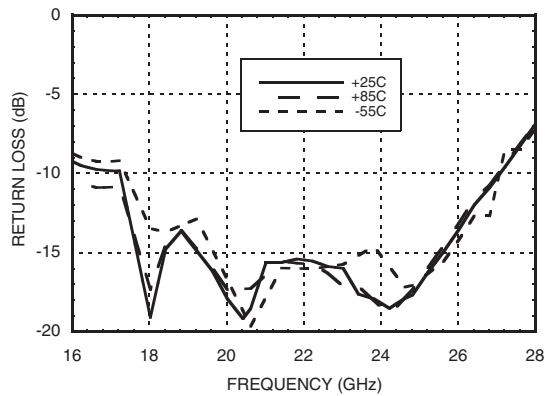

Output Return Loss vs. Temperature

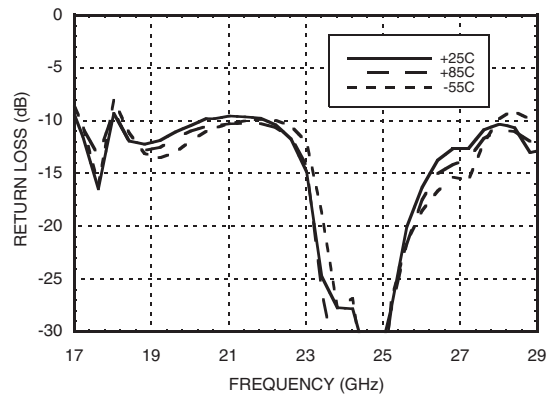

Reverse Isolation vs. Temperature

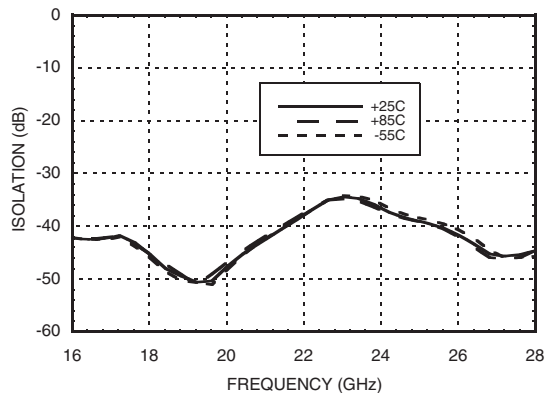

Noise Figure vs. Temperature

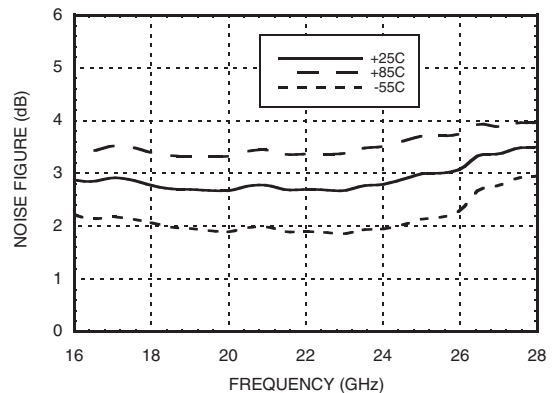



WIDEBAND LNA MODULE, 17 - 27 GHz

P1dB vs. Temperature

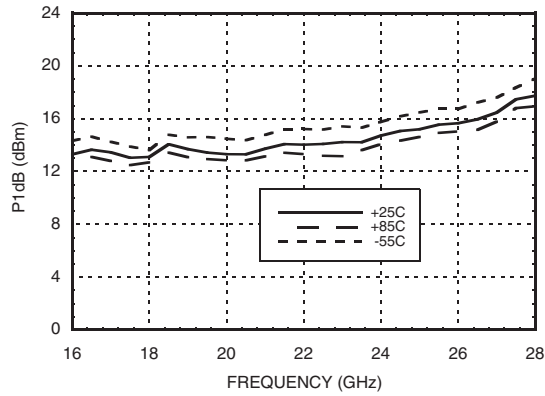

Psat vs. Temperature

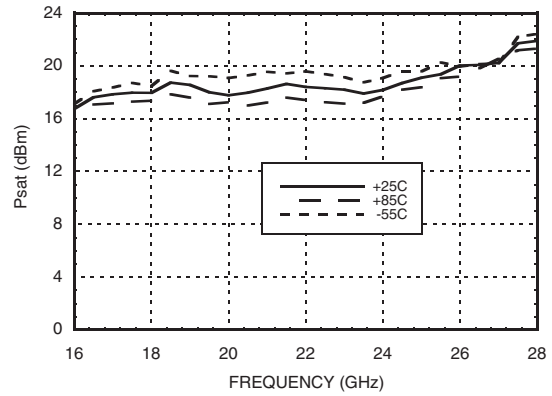

Output IP3 vs. Temperature

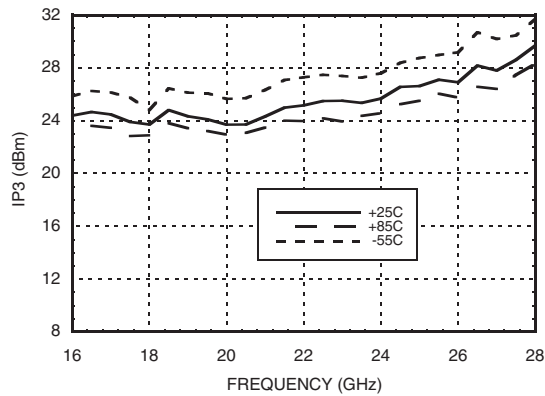

Power Compression @ 21 GHz

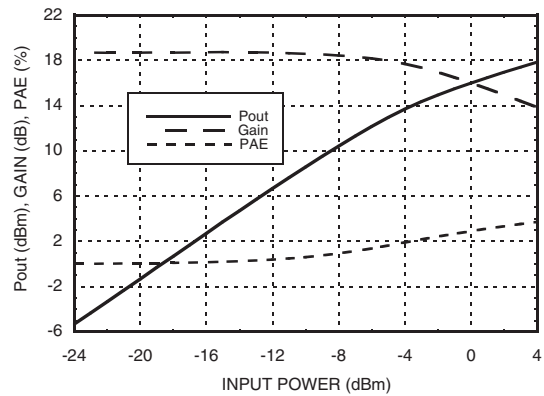

Absolute Maximum Ratings



Bias Supply Voltage (Vs)	-0.3 Vdc to +25 Vdc
RF Input Power (RFIN)	+10 dBm
Storage Temperature	-65 to +150 °C
Operating Temperature	-55 to +85 °C



ELECTROSTATIC SENSITIVE DEVICE
OBSERVE HANDLING PRECAUTIONS

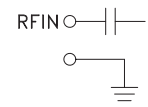
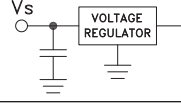
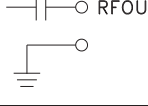

Pin Descriptions

Pin Number	Function	Description	Interface Schematic
1	RFIN & RF Ground	RF input connector, coaxial female, field replaceable. This pin is AC coupled and matched to 50 Ohms.	
2	Vs	Power supply voltage for the amplifier.	
3	RFOUT & RF Ground	RF output connector, coaxial female, field replaceable. This pin is AC coupled and matched to 50 Ohms.	
4	GND	Power supply ground.	



Outline Drawing

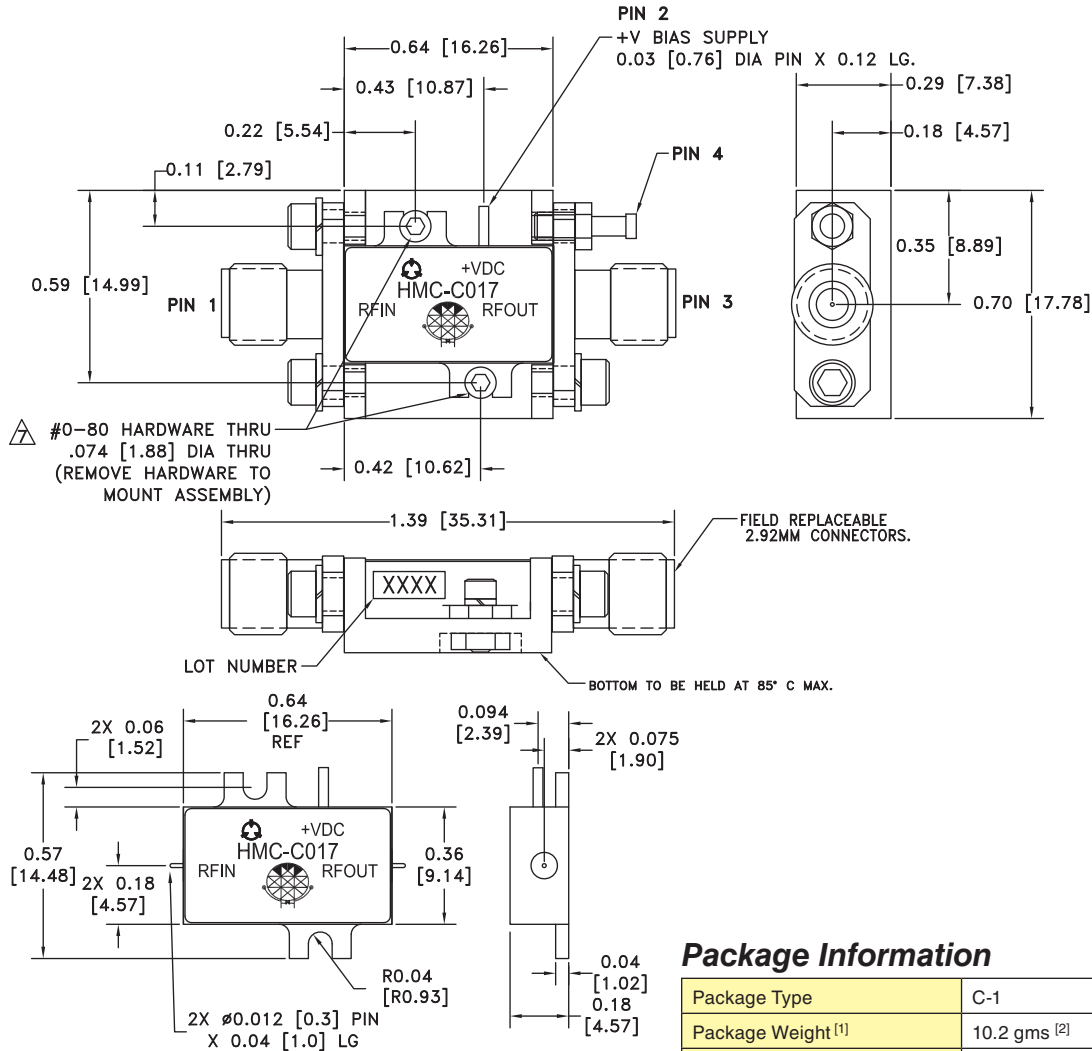

Package Information

Package Type	C-1
Package Weight [1]	10.2 gms [2]
Spacer Weight	N/A

[1] Includes the connectors

[2] ±1 gms Tolerance

NOTES:

1. PACKAGE, LEADS, COVER MATERIAL: KOVAR™
2. SPACER MATERIAL: ALUMINUM
3. PLATING: ELECTROLYTIC GOLD 50 MICROINCHES MIN., OVER ELECTROLYTIC NICKEL 75 MICROINCHES MIN.
4. ALL DIMENSIONS ARE IN INCHES [MILLIMETERS].
5. TOLERANCES ±.005 [0.13] UNLESS OTHERWISE SPECIFIED.
6. FIELD REPLACEABLE 2.92mm CONNECTORS. TENSOLITE 231CCSF OR EQUIVALENT.

⚠ TO MOUNT MODULE TO SYSTEM PLATFORM REPLACE 0-80 HARDWARE WITH DESIRED MOUNTING SCREWS.



MICROWAVE CORPORATION v02.1007



HMC-C017

WIDEBAND LNA MODULE, 17 - 27 GHz

Notes: