

# Type C2Q

## Surface Mount Very Fast-Acting Chip Fuse

0603 Size  
RoHS 6 Compliant



### C2Q Series Fuse



#### Features

- Fast Acting
- Small size,0603 SMD
- Current rating from 250mA to 5A
- Wide operating temperature range from -55°C to 125°C
- Tape and Reel for automatic SMD placement
- Compatible with reflow and wave soldering
- RoHS6 compliant
- Halogen Free
- Leadfree

#### Applications

- Notebook
- LCD monitor
- PC computer
- Office electronic equipment
- Industrial equipment
- Medical equipment
- POE, POE+
- LCD / LED monitor
- Power supply
- LCD / LED TV
- DC-DC Converter

HALOGEN FREE =   
 LEAD FREE =

#### Electrical Characteristics (UL STD.248-14)

Testing Current	Blow Time	
	Minimum	Maximum
100%	4 Hrs.	N/A
200%	N/A	5 Sec
300%	N/A	0.2 Sec

#### Safety Agency Approvals

SAFETY AGENCY	SAFETY AGENCY CERTIFICATE	AMPERE RANGE / VOLT @ I.R.ABILITY
	E20624	250mA - 4A / 32V AC @ 35A and 63V DC @ 50A
		5A / 32V AC & DC @ 50A
		250mA - 4A / 32V AC @ 35A and 63V DC @ 50A 5A / 32V AC & DC @ 50A

Specifications Subject to change without notice.

**Type C2Q**  
Surface Mount Very Fast-Acting Chip Fuse

0603 Size  
RoHS 6 Compliant



C2Q May2012C

**Electrical Specifications**

Catalog Number	Ampere Rating (A)	Nominal Cold Resistance (ohm)	Nominal Volt-drop @100% In (volt)	Interrupting Rating	Voltage Rating (V)	Nominal Melting I <sup>2</sup> T <10 m Sec (A <sup>2</sup> Sec)	Nominal Melting I <sup>2</sup> T @ 10 In (A <sup>2</sup> Sec)	Nominal Power Dissipation @100% In (W)	Agency Approvals		
C2Q 250	250mA	0.77	0.243	250mA - 4A / 32V AC @ 35A and 63V DC @ 50A	63	0.002	0.0001	0.06	Y	Y	
C2Q 300	300mA	0.54	0.217		63	0.003	0.0001	0.07	Y	Y	
C2Q 375	375mA	0.42	0.196		63	0.005	0.0002	0.07	Y	Y	
C2Q 500	500mA	0.28	0.171		63	0.009	0.0004	0.09	Y	Y	
C2Q 750	750mA	0.17	0.159		63	0.020	0.0011	0.12	Y	Y	
C2Q 1	1A	0.122	0.154		63	0.036	0.002	0.15	Y	Y	
C2Q 1.25	1.25A	0.092	0.144		63	0.058	0.004	0.18	Y	Y	
C2Q 1.5	1.5A	0.073	0.138		63	0.084	0.006	0.21	Y	Y	
C2Q 2	2A	0.053	0.133		63	0.15	0.011	0.27	Y	Y	
C2Q 2.5	2.5A	0.042	0.130		63	0.24	0.019	0.33	Y	Y	
C2Q 3	3A	0.034	0.130		63	0.36	0.030	0.39	Y	Y	
C2Q 3.5	3.5A	0.028	0.131		63	0.50	0.044	0.46	Y	Y	
C2Q 4	4A	0.023	0.131		63	0.63	0.059	0.52	Y	Y	
C2Q 5	5A	0.019	0.131		5A / 32V AC & DC @ 50A	32	1.05	0.103	0.66	Y	Y

Temperature Derating Curve

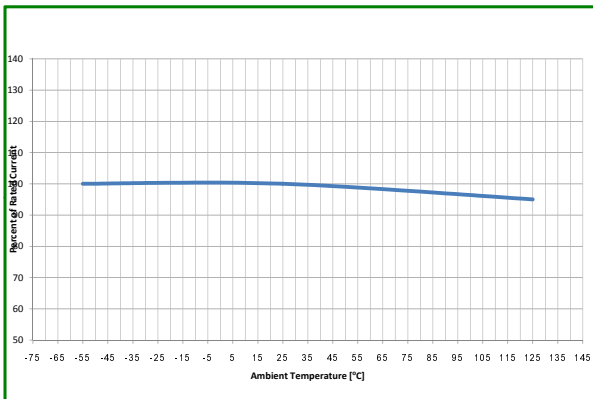

Average Time Current Curve

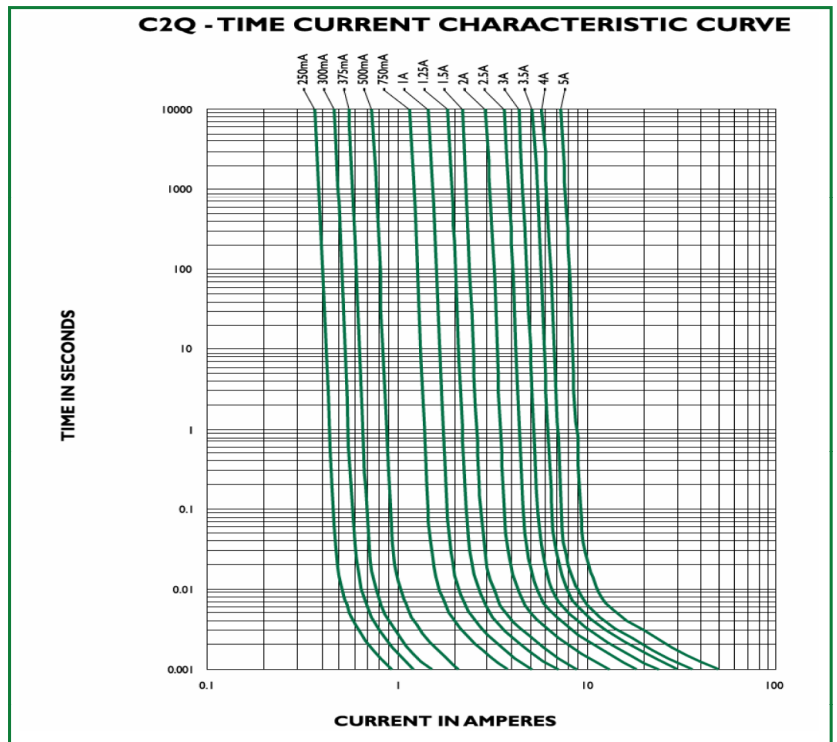

Specifications Subject to change without notice.

**CORPORATE OFFICE**

Bel Fuse Inc.  
206 Van Vorst Street  
Jersey City, NJ 07302  
Tel 201-432-0463  
Fax 201-432-9542  
E-Mail: belfuse@belf.com  
Website: www.belfuse.com

**FAR EAST OFFICE**

Bel Fuse Ltd.  
8/F Luk Hop Industrial Building  
8 Luk Hop Street  
San Po Kong  
Kowloon, Hong Kong  
Tel 852-2328-5515  
Fax 852-2352-3706

**EUROPE OFFICE**

Bel Fuse Europe Ltd.  
Preston Technology Management Centre  
Marsh Lane, Suite F15  
Preston, Lancashire, PR1 8UQ  
United Kingdom  
Tel 44-1772-556601  
Fax 44-1772-561008

**EUROPE**

Bel Stewart GmbH  
Industriestrasse 20  
61381 Friedrichsdorf  
Germany  
Tel 49-6172-9552-0  
Fax 49-6172-9552-40

**Soldering Parameters**

Lead-Free IR Reflow Profile (IPC/JEDEC J-STD-020D)	
Reflow Parameter	
Minimum preheat temperature (TsMIN)	150 °C
Maximum preheat temperature (TsMAX)	200 °C
Preheat Time	60-180 seconds
TsMAX to TL ramp-up rate	3 °C/second max.
Time above temperature TL (tL)	217 °C 60-120 seconds
Peak Temperature (TP)	260 °C max.
Time within 5° of Peak TP	20-40 seconds
Ramp-down rate	6 °C/second max.

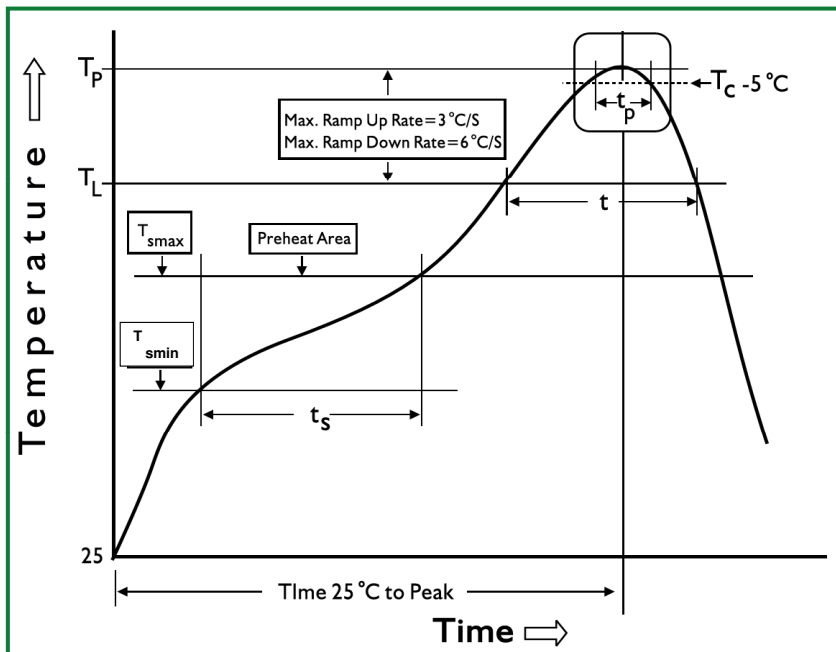

Lead-free Wave Soldering Profile	
Wave Soldering Parameter	
Average ramp-up rate	200°C / second
Heating rate during preheat	typical 1 - 2 °C / second Max. 4°C/ second
Final preheat temperature	within 125°C of soldering temperature
Peak temperature (TP)	260°C
Time within +0°C / -5°C of actual peak temperature	10 seconds
Ramp-down rate	5 °C / second max.

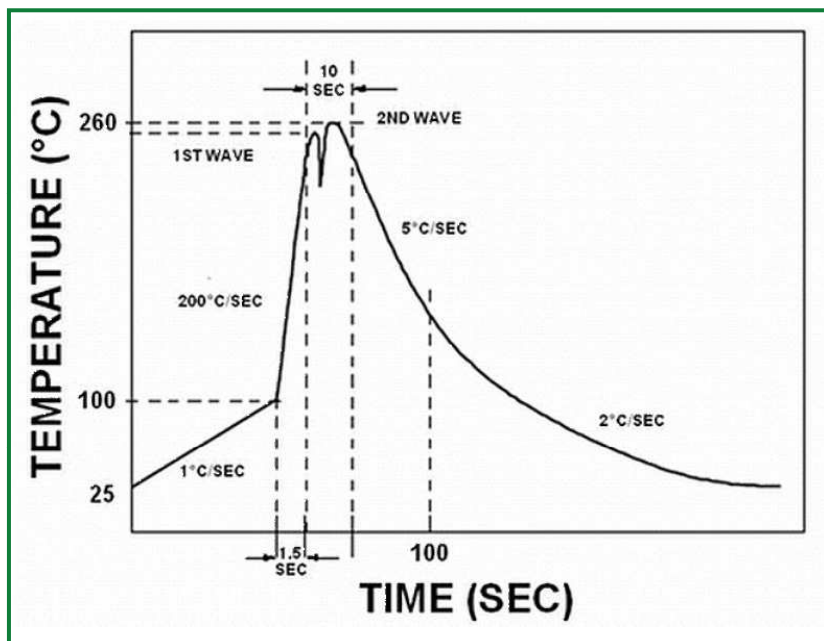

Specifications Subject to change without notice.

# Type C2Q





## Surface Mount Very Fast-Acting Chip Fuse

0603 Size  
RoHS 6 Compliant  
HF Pb

# bel

C2Q May 2012D

### Physical Specifications

<b>Materials</b>	Body : Ceramic Substrate
	Terminations: Ag / Ni / Sn (100% Lead -free)
	Element Cover Coating : Lead-free Glass
<b>Marking</b>	On Fuse:
	<b>None</b>
	On label:
	"bel" , "C2Q", "Current Rating", "Voltage Rating", "Interrupting Rating", "Appropriate Safety Logos" and "  ",  "(China RoHS compliant)."  

### Environmental Specifications

<b>Shock Resistance</b>	MIL-STD-202G, Method 213B, Test Condition I (100 G's peak for 6 milliseconds; Sawtooth Waveform)
<b>Vibration Resistance</b>	MIL-STD-202G, Method 201A (10-55 Hz, 0.06 inch, total excursion).
<b>Salt Spray Resistance</b>	MIL-STD-202G, Method 101E, Test condition B (48 hrs).
<b>Insulation Resistance</b>	MIL-STD-202G, Method 302, Test Condition A (After Opening) 10,000 ohms minimum.
<b>Solderability</b>	MIL-STD-202G, Method 208H
<b>Resistance to solder Heat</b>	MIL-STD-202G Method 210F, Test Condition C. Top Side (260 °C, 20 sec) MIL-STD-202G Method 210F, Test Condition D. Bottom Side (260 °C, 10 sec)
<b>Thermal Shock</b>	MIL-STD-202G, Method 107G, Test Condition B (-65 °C to +125 °C).
<b>Operating Temperature</b>	-55 °C to +125 °C

### Mechanical Dimensions

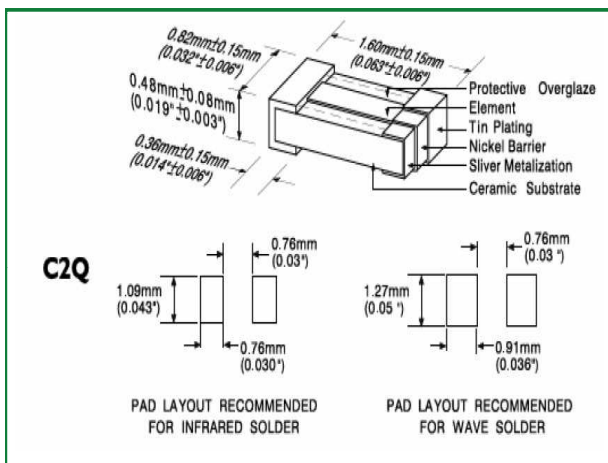

### Ordering Information

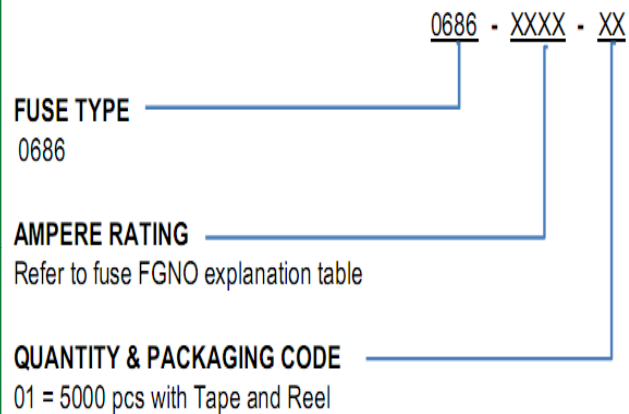

### Packaging

Packaging Tape & Reel	Packaging Specification	Quantity	Quantity & Packaging Code
8 mm wide tape with 7 inches Diameter reel	EIA Standard 481-D	5000	0686-XXXX-01

Specifications Subject to change without notice.

**CORPORATE OFFICE**  
Bel Fuse Inc.  
206 Van Vorst Street  
Jersey City, NJ 07302  
Tel 201-432-0463  
Fax 201-432-9542  
E-Mail: belfuse@belf.com  
Website: www. belfuse.com

**FAR EAST OFFICE**  
Bel Fuse Ltd.  
8/F Luk Hop Industrial Building  
8 Luk Hop Street  
San Po Kong  
Kowloon, Hong Kong  
Tel 852-2328-5515  
Fax 852-2352-3706

**EUROPE OFFICE**  
Bel Fuse Europe Ltd.  
Preston Technology Management Centre  
Marsh Lane, Suite F15  
Preston, Lancashire, PR1 8UQ  
United Kingdom  
Tel 44-1772-556601  
Fax 44-1772-561008

**EUROPE**  
Bel Stewart GmbH  
Industriestrasse 20  
61381 Friedrichsdorf  
Germany  
Tel 49-6172-9552-0  
Fax 49-6172-9552-40