



0.1 - 15 GHz LOW NOISE PROGRAMMABLE DIVIDER (N = 1, 2, 4, 8)

Typical Applications

The HMC862LP3E is ideal for:

- Satellite Communication Systems
- Point-to-Point & Point-to-Multi-Point Radios
- Military Applications
- Test Equipment

Functional Diagram

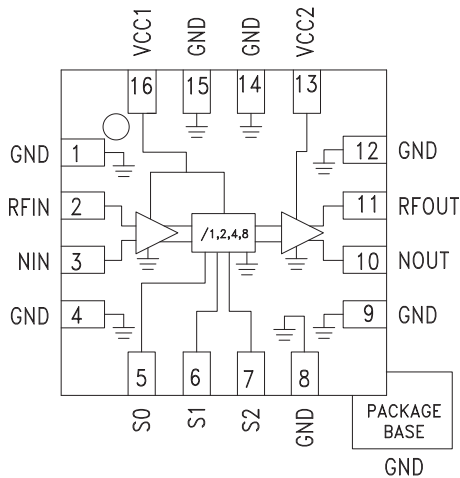

Features

- Low Noise Floor: -153 dBc/Hz at 100 kHz offset
- Programmable Frequency Divider, N = 1, 2, 4, 8
- Wide Bandwidth: 100 MHz to 15 GHz
- 16 Lead 3X3 mm SMT Package: 9mm²

General Description

The HMC862LP3E is a low noise programmable frequency divider in a 3x3 mm leadless surface mount package. The divider can be programmed to divide from N=1, 2, 4, 8 in the 100 MHz to 15 GHz input frequency range. The low phase noise, wide frequency range and flexible division ratio make this device ideal for high performance and wide band communication systems.

Electrical Specifications, $T_A = +25^\circ C$, $V_{cc1} = V_{cc2} = +5V$

| Parameter | Conditions | Min. | Typ. | Max. | Units |
|---------------------------------------|--|------|------------|------|--------|
| RF Input Characteristics | | | | | |
| Max RF Input Frequency | Sine Wave or Square Wave Input | 15 | | | GHz |
| Min RF Input Frequency | Sine Wave or Square Wave Input ^[1] | | | 0.1 | GHz |
| RF Input Power Range (N = 1) | Sine Wave or Square Wave Input ^{[1][2]} Fin < 8 GHz | -10 | | 10 | dBm |
| | Sine Wave or Square Wave Input ^{[1][2]} Fin > 8 GHz | -10 | | 0 | dBm |
| RF Input Power Range (N = 2, 4, 8) | Sine Wave or Square Wave Input ^[1] | -10 | | 10 | dBm |
| Divider Output Characteristics | | | | | |
| Output Power (N = 1) | (see the Pout plot for N = 1) ^[2] | | -2 to +3 | | dBm |
| Output Power (N = 2, 4, 8) | (see the Pout plots for each division ratio) | | 2 | | dBm |
| Divider Ratio N | | | 1, 2, 4, 8 | | |
| SSB Phase Noise @ 100 kHz Offset | Fin = 6 GHz, Pin = 0 dBm, N = 2 | | -153 | | dBc/Hz |
| Logic Inputs | | | | | |
| VIH Input High Voltage | | 3 | | 5 | V |
| VIL Input Low Voltage | | 0 | | 0.4 | V |
| Power Supplies | | | | | |
| Vcc | Analog Supply | 4.75 | 5 | 5.25 | V |
| Current Consumption | | | | | |
| Icc | N = 1, S0 = L, S1 = L, S2 = L | | 106 | | mA |
| | N = 2, S0 = H, S1 = L, S2 = L | | 143 | | mA |
| | N = 4, S0 = H, S1 = H, S2 = L | | 153 | | mA |
| | N = 8, S0 = H, S1 = H, S2 = H | | 162 | | mA |
| Control Bits | | | 3 | | Bit |

[1] Square wave input waveform is recommended below 400 MHz for best phase noise performance. If sine wave input waveform is used below 400 MHz, it is recommended that power input is > +5 dBm for best operation including phase noise performance.

[2] For N = 1, frequencies > 8 GHz, and input power > 0 dBm, output power will saturate and gradually drop with increasing input power, but part will continue to function.



0.1 - 15 GHz LOW NOISE PROGRAMMABLE DIVIDER (N = 1, 2, 4, 8)

Divide-by-1

Input Sensitivity vs. Temperature

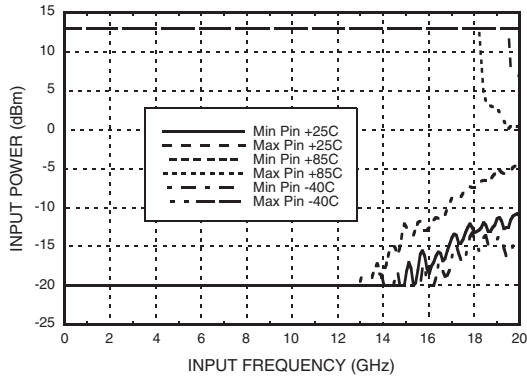

Output Power vs. Temperature, Pin = 0 dBm

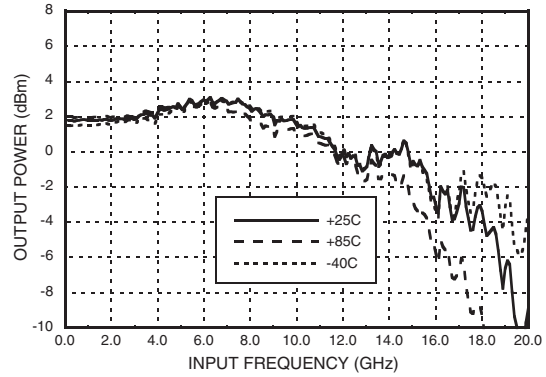

Phase Noise vs. Frequency, Pin = 0 dBm

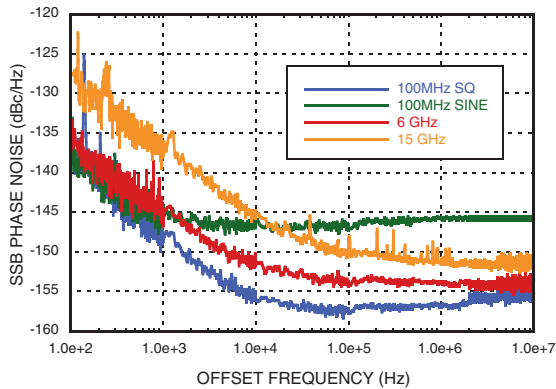

Phase Noise vs. Temperature, Pin = 0 dBm, Fin = 6 GHz

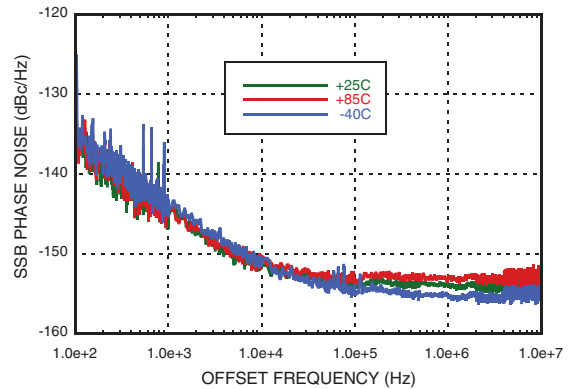

Output Harmonics, Pin = 0 dBm T = 25 °C

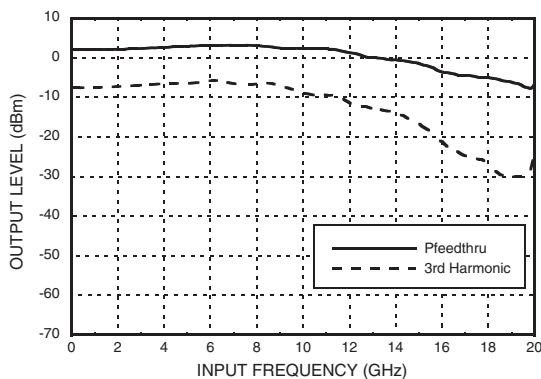

Reverse Leakage, Pin = 0 dBm T = 25 °C

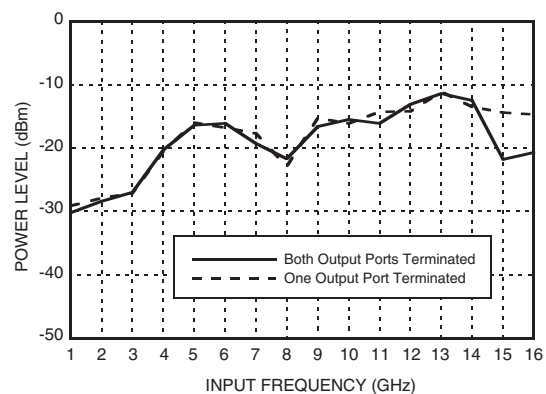



0.1 - 15 GHz LOW NOISE PROGRAMMABLE DIVIDER (N = 1, 2, 4, 8)

Divide-by-2

4

FREQUENCY DIVIDERS & DETECTORS - SMT

Input Sensitivity vs. Temperature

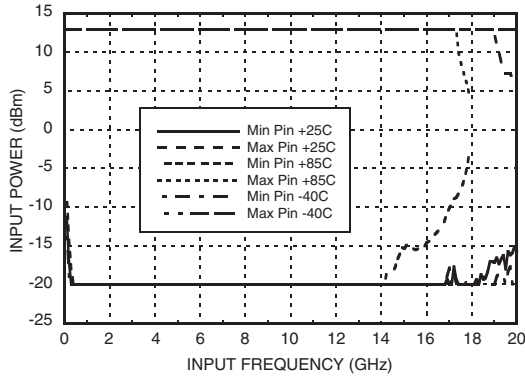

Output Power vs. Temperature, Pin = 0 dBm

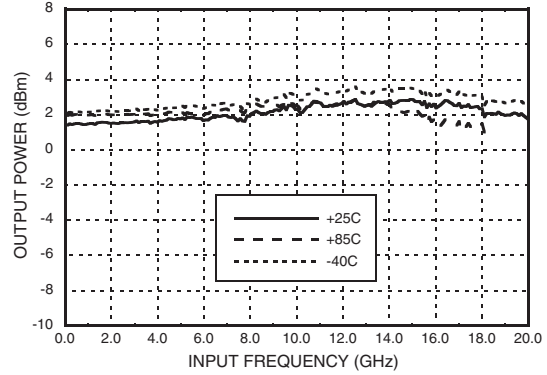

Phase Noise vs. Frequency, Pin = 0 dBm

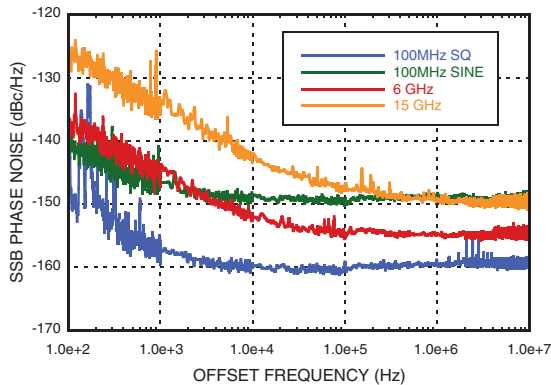

**Phase Noise vs. Temperature
Pin = 0 dBm, Fin = 6 GHz**

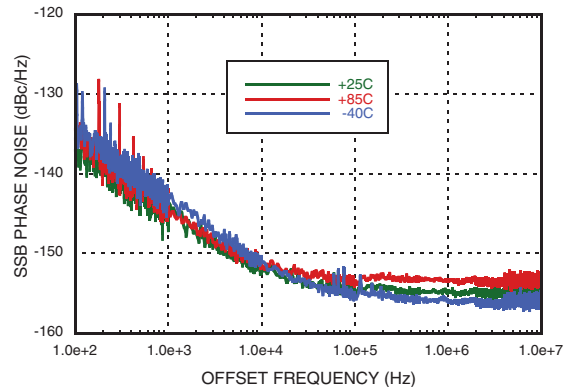

Output Harmonics, Pin = 0 dBm T = 25 °C

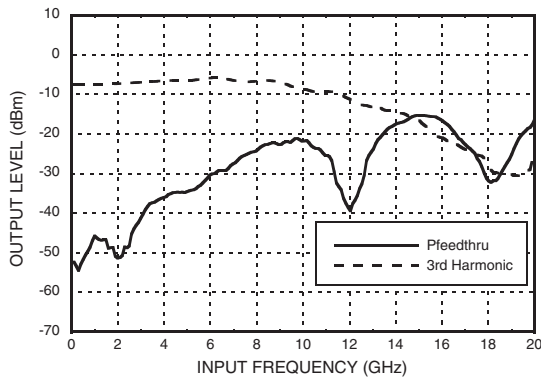

Reverse Leakage, Pin = 0 dBm T = 25 °C

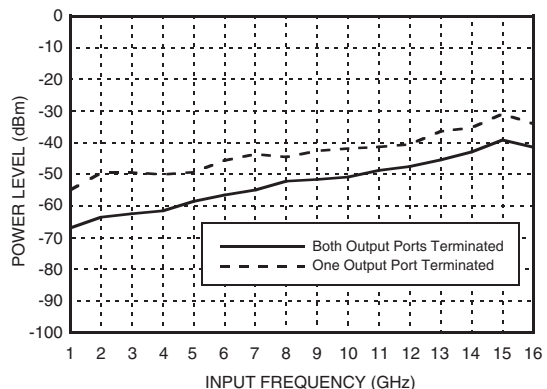



**0.1 - 15 GHz LOW NOISE PROGRAMMABLE
DIVIDER (N = 1, 2, 4, 8)**

Divide-by-4

Input Sensitivity vs. Temperature

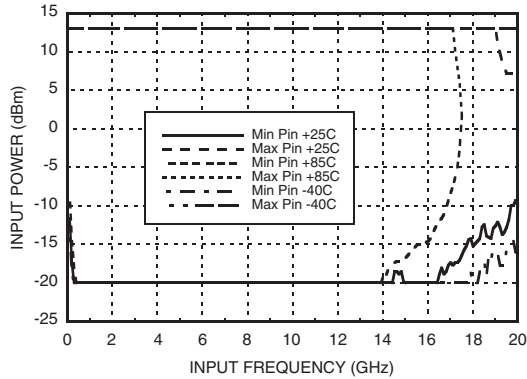

Output Power vs. Temperature, Pin = 0 dBm

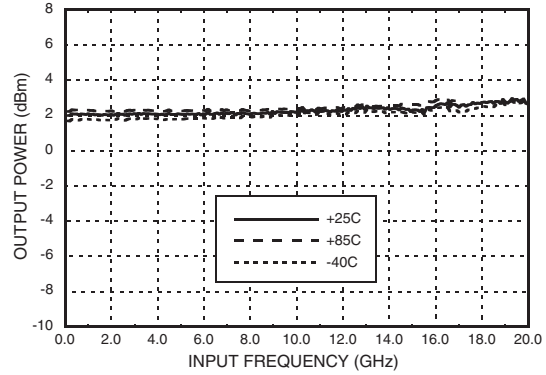

Phase Noise vs. Frequency, Pin = 0 dBm

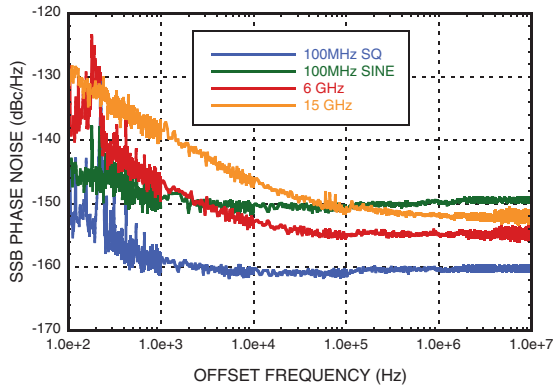

**Phase Noise vs. Temperature
Pin = 0 dBm, Fin = 6 GHz**

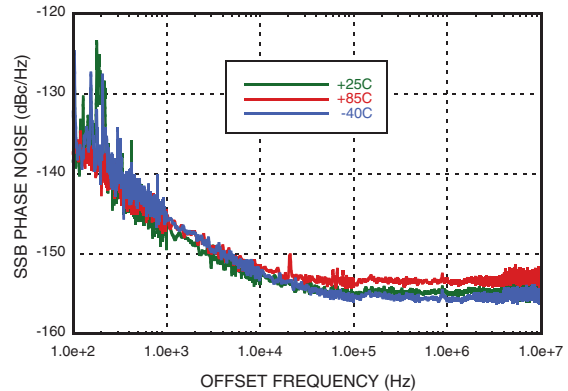

Output Harmonics, Pin = 0 dBm T = 25 °C

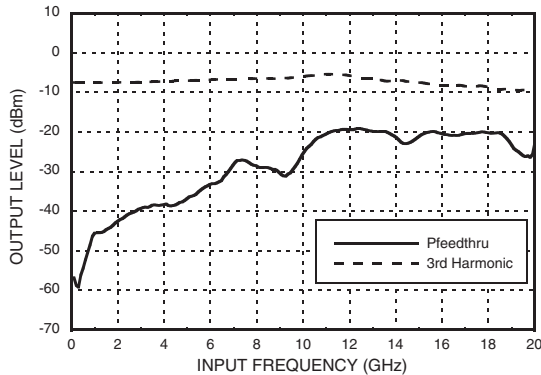

Reverse Leakage, Pin = 0 dBm T = 25 °C

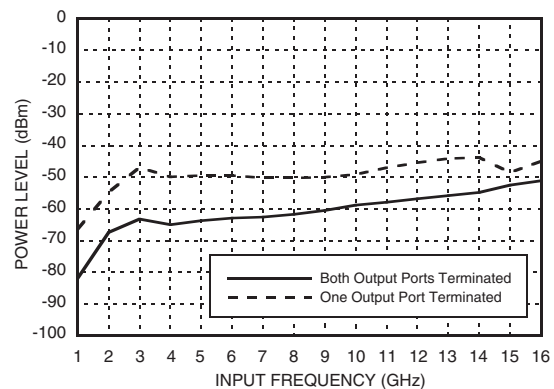



0.1 - 15 GHz LOW NOISE PROGRAMMABLE DIVIDER (N = 1, 2, 4, 8)

Divide-by-8

4

FREQUENCY DIVIDERS & DETECTORS - SMT

Input Sensitivity vs. Temperature

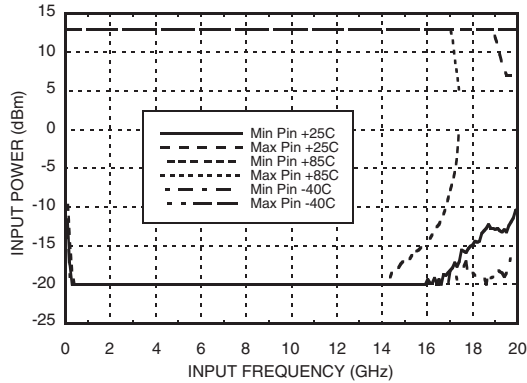

Output Power vs. Temperature, Pin = 0 dBm

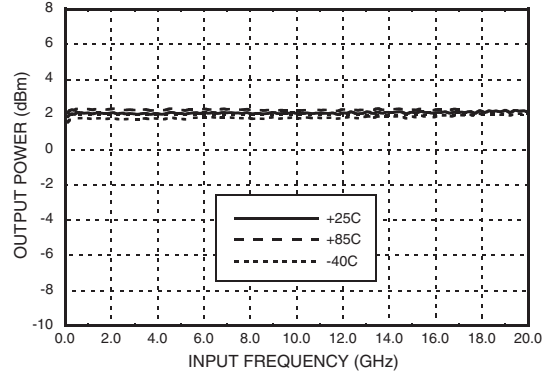

Phase Noise vs. Frequency, Pin = 0 dBm

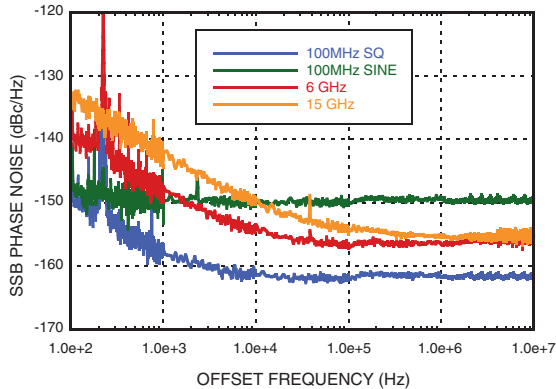

**Phase Noise vs. Temperature
Pin = 0 dBm, Fin = 6 GHz**

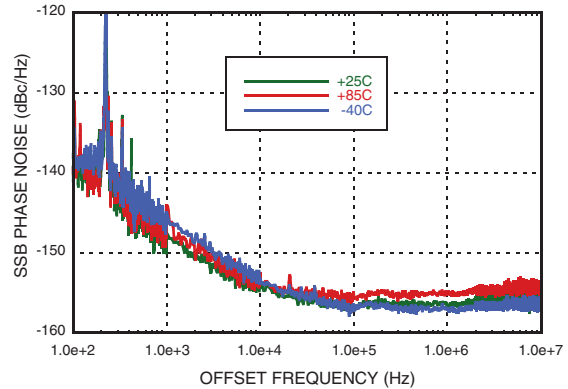

Output Harmonics, Pin = 0 dBm T = 25 °C

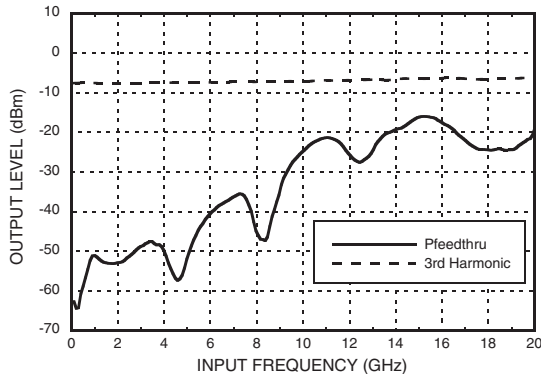

Reverse Leakage, Pin = 0 dBm T = 25 °C

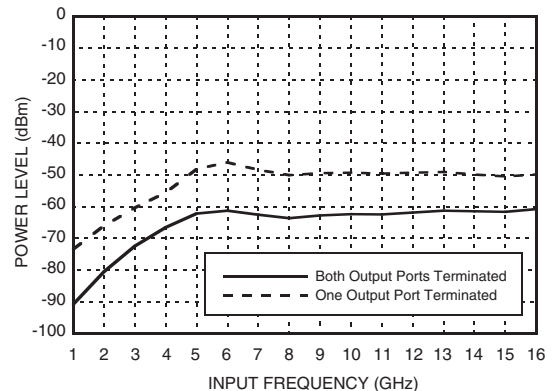



0.1 - 15 GHz LOW NOISE PROGRAMMABLE DIVIDER (N = 1, 2, 4, 8)

I_{cc} vs. V_{cc}

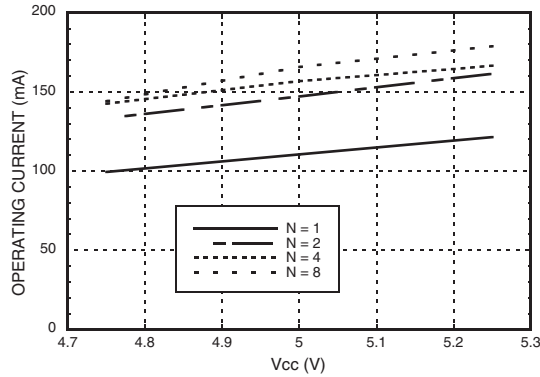

Absolute Maximum Ratings

| | |
|-----------------------------------|------------------------------------|
| RF Input Power | 13 dBm |
| Supply Voltage (V _{cc}) | 5.5V |
| Logic Inputs (S0, S1, S2) | -0.5V to (0.5V + V _{cc}) |
| Storage Temperature | -65 to +125 °C |
| ESD Sensitivity (HBM) | Class 1A |



ELECTROSTATIC SENSITIVE DEVICE
OBSERVE HANDLING PRECAUTIONS

Programming Truth Table for Frequency Division Ratios

| S0 | S1 | S2 | Divider Ratio (N) |
|----|----|----|-------------------|
| 0 | 0 | 0 | 1 |
| 1 | 0 | 0 | 2 |
| 1 | 1 | 0 | 4 |
| 1 | 1 | 1 | 8 |

0 = Logic Low 1 = Logic High
Note: V_{cc1}, V_{cc2} must be applied before logic.

Digital Control Input Voltages

| State | S0, S1, S2 |
|-------|------------|
| Low | 0 to 0.4V |
| High | 3V to 5V |

Reliability Information

| | |
|--|---------------|
| Junction Temperature to Maintain 1 Million Hour MTTF | 150 °C |
| Nominal Junction Temperature (T = 85 °C) | 112 °C |
| Thermal Resistance (Junction to GND Paddle, 5V Supply) | 33 °C/W |
| Operating Temperature | -40 to +85 °C |



**0.1 - 15 GHz LOW NOISE PROGRAMMABLE
DIVIDER (N = 1, 2, 4, 8)**

Outline Drawing

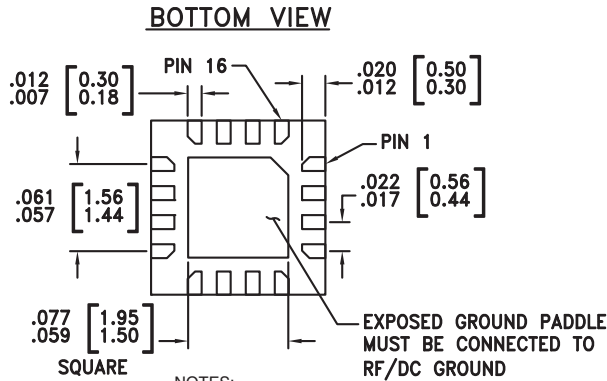
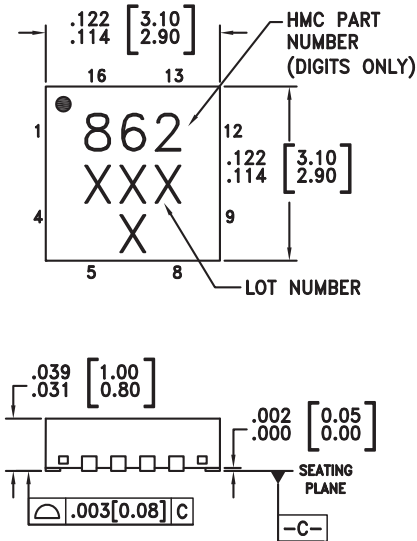

- NOTES:
1. LEADFRAME MATERIAL: COPPER ALLOY
 2. DIMENSIONS ARE IN INCHES [MILLIMETERS].
 3. LEAD SPACING TOLERANCE IS NON-CUMULATIVE
 4. PAD BURR LENGTH SHALL BE 0.15mm MAXIMUM.
PAD BURR HEIGHT SHALL BE 0.05mm MAXIMUM.
 5. PACKAGE WARP SHALL NOT EXCEED 0.05mm.
 6. ALL GROUND LEADS AND GROUND PADDLE MUST BE SOLDERED TO PCB RF GROUND.
 7. REFER TO HITTITE APPLICATION NOTE FOR SUGGESTED PCB LAND PATTERN.

Package Information

| Part Number | Package Body Material | Lead Finish | MSL Rating | Package Marking ^[1] |
|-------------|--|---------------|---------------------|--------------------------------|
| HMC862LP3E | RoHS-compliant Low Stress Injection Molded Plastic | 100% matte Sn | MSL1 ^[2] | 862 XXX |

[1] 4-Digit lot number XXXX

[2] Max peak reflow temperature of 260 °C



0.1 - 15 GHz LOW NOISE PROGRAMMABLE DIVIDER (N = 1, 2, 4, 8)

Pin Description

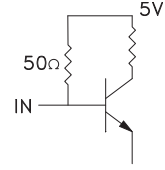
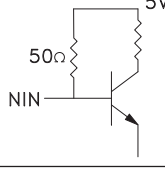
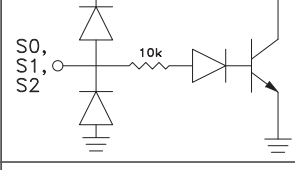
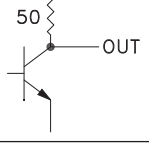
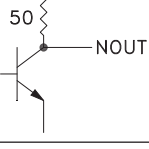
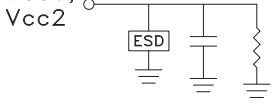
| Pin Number | Function | Description | Interface Schematic |
|------------------------|--------------------------|--|---|
| 1, 4, 8, 9, 12, 14, 15 | GND | Ground: Backside of package has exposed metal ground slug which must be connected to RF/DC ground. |  |
| 2 | IN | RF Input must be DC blocked. |  |
| 3 | $\overline{\text{NIN}}$ | RF Input 180° out of phase with pin 2 for differential operation. AC ground for single ended operation. DC block for differential operation. |  |
| 5, 6, 7 | S0, S1, S2 | CMOS compatible division ratio control bit. See Programming Truth Table |  |
| 10 | $\overline{\text{NOUT}}$ | Divider output 180° out of phase with pin 11. RF output must be DC blocked. |  |
| 11 | OUT | Divided Output. RF output must be DC blocked. |  |
| 13, 16 | Vcc1, Vcc2 | Supply voltage 5V. Connect both pins to +5V supply. |  |



0.1 - 15 GHz LOW NOISE PROGRAMMABLE DIVIDER (N = 1, 2, 4, 8)

Evaluation PCB

4

FREQUENCY DIVIDERS & DETECTORS - SMT

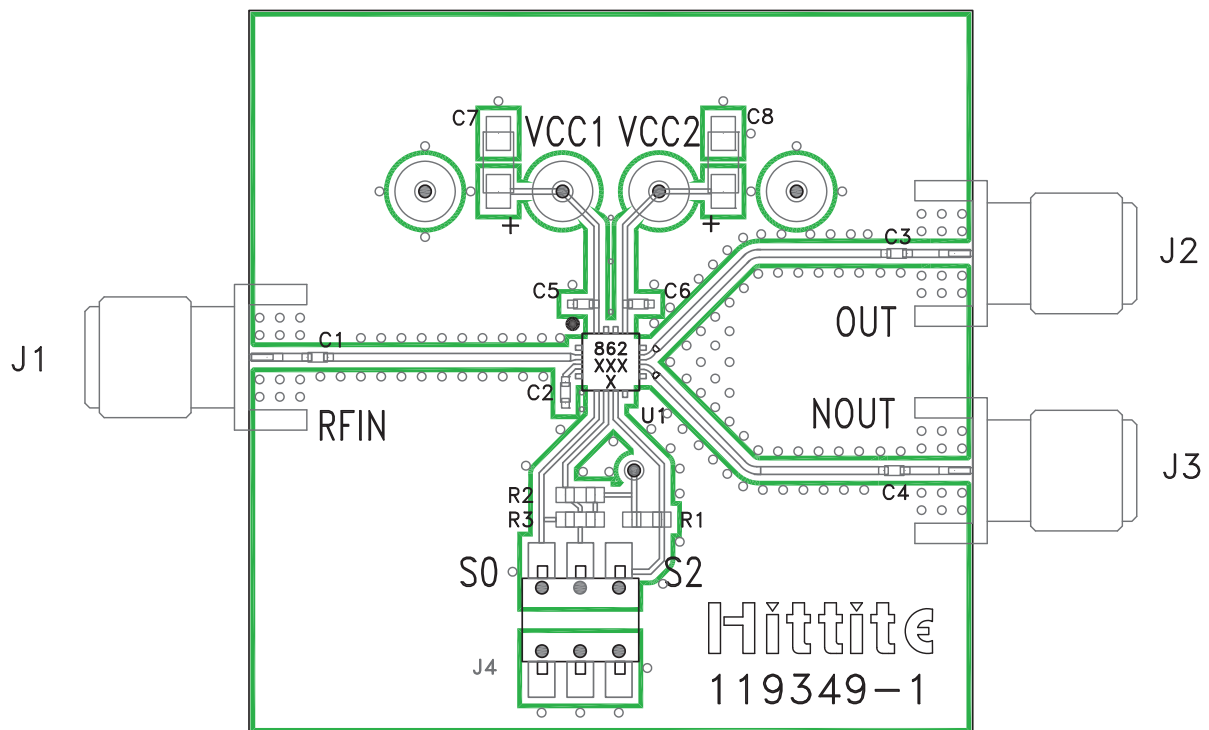

List of Materials for Evaluation PCB 119351 [1]

| Item | Description |
|------------|--|
| J1 - J3 | PCB Mount SMA-F RF Connector |
| J4 | DC Connector Header, Molex 2mm |
| C1 - C4 | ATC530L, 100 nF, 16V, Broadband Capacitor, 0402 Pkg. |
| C5, C6 | 1000 pF Capacitor, 0402 Pkg. |
| C7, C8 | 4.7 μF Capacitor, Tantalum, 1206 Pkg. |
| R1 - R3 | 10 kOhm Resistor, 0402 Pkg. |
| Vcc1, Vcc2 | Mill-Max 0.040" Dia. PC Pin, 3101-2-00-21-00-00-08-0 |
| U1 | HMC862LP3E, Programmable Divider |
| PCB [2] | 119349 Evaluation Board |

[1] Reference this number when ordering complete evaluation PCB

[2] Circuit Board Material: Rogers 4350 or Arlon 25FR

The circuit board used in the application should use RF circuit design techniques. Signal lines should have 50 ohm impedance while the package ground leads and backside ground paddle should be connected directly to the ground plane similar to that shown. A sufficient number of via holes should be used to connect the top and bottom ground planes. The evaluation circuit board shown is available from Hittite upon request.



**0.1 - 15 GHz LOW NOISE PROGRAMMABLE
DIVIDER (N = 1, 2, 4, 8)**

Evaluation PCB Schematic

