

Features

- RF Bandwidth: 3365 to 3705 MHz
- Ultra Low Phase Noise
-98 dBc/Hz in Band Typ
- Figure of Merit (FOM) -227 dBc
- < 180 fs rms Jitter
(Integrated 100 Hz to 100 MHz SSB)
- 24-bit Frequency Step Size,
Resolution 3 Hz typ
- Exact Frequency Mode
- Built-in Digital Self Test
- 40 Lead 6x6 mm SMT Package: 36 mm²

Typical Applications

- Cellular/4G Infrastructure
- Repeaters and Femtocells
- Communications Test Equipment
- CATV Equipment
- Phased Array Applications
- DDS Replacement
- Very High Data Rate Radios

Functional Diagram

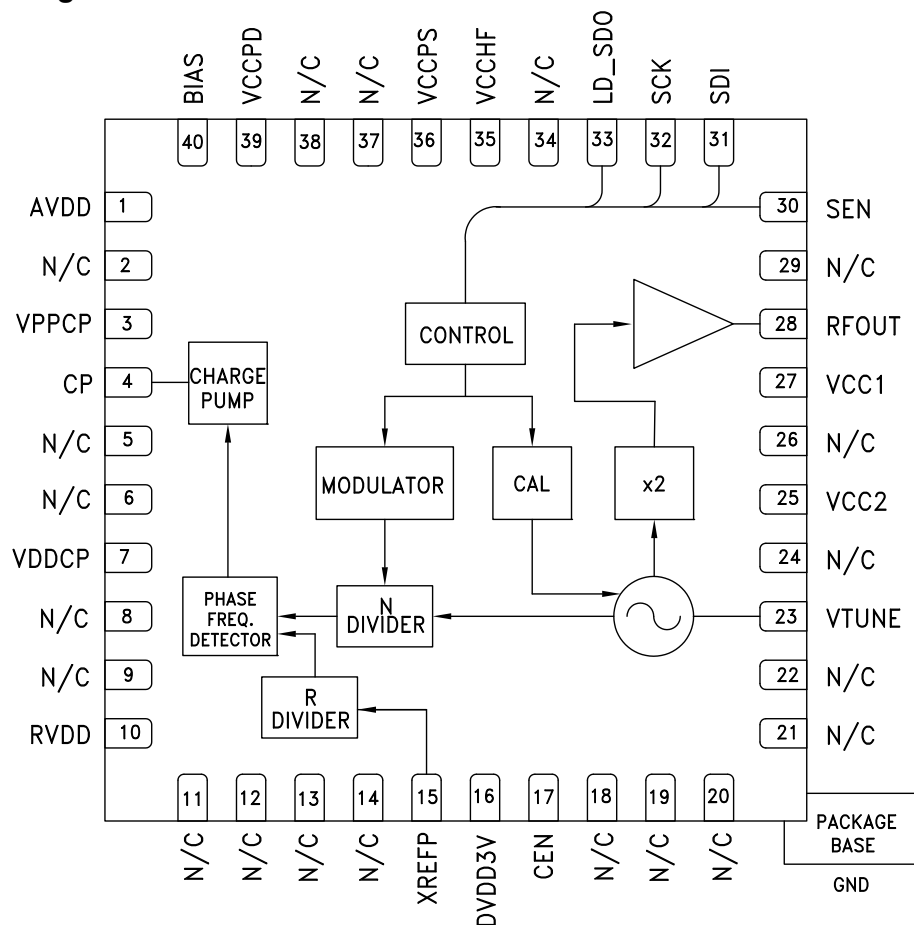



FRACTIONAL-N PLL WITH INTEGRATED VCO, 3365 - 3705 MHz

General Description

The HMC836LP6CE is a fully functioned Fractional-N Phase-Locked-Loop (PLL) with an Integrated Voltage Controlled Oscillator (VCO). The PLL consists of an integrated low noise VCO with x2 output, an autocalibration subsystem for low voltage VCO tuning, a very low noise digital Phase Detector (PD), a precision controlled charge pump, a low noise reference path divider and a fractional divider.

The fractional PLL features an advanced delta-sigma modulator design that allows both fine step sizes and low spurious products. The phase detector (PD) features cycle slip prevention (CSP) technology to allow faster frequency hopping times. Ultra low in-close phase noise and low spurious also allows wider loop bandwidths for faster frequency hopping and low micro-phonics.

For theory of operation and register map refer to the “PLLs with Integrated VCOs - RF VCOs Operating Guide”. To view the Operating Guide, please visit www.hittite.com and choose HMC836LP6CE from the “Search by Part Number” pull down menu.

Electrical Specifications, $T_A = +25^\circ\text{C}$

VPPCP, VDDCP, VCC1, VCC2 = 5V ±4%; RVDD, AVDD, DVDD3V, VCCPD, VCCHF, VCCPS = 3.3V ±6% GNDCP = GNDLS = Ground Paddle = 0V

Parameter	Condition	Min.	Typ.	Max.	Units
RF Output Characteristics					
VCO Frequency		1682.5		1852.5	MHz
RF Output Frequency at $f_{VCO} \times 2$		3365		3705	MHz
RF Output Power at $f_{VCO} \times 2$		-1	6	9	dBm
VCO Tuning Sensitivity	Measured at 2 GHz, 2V		15		MHz/V
VCO Supply Pushing	Measured at 2 GHz, 2V	-2		1.5	MHz/V
RF Output 2nd Harmonic			-25		dBc
RF Output 3rd Harmonic			-23		dBc
RF Output 4th Harmonic			-31		dBc
RF Divider Characteristics					
19-Bit N-Divider Range (Integer)	Max = $2^{19} - 1$	16		524,287	
19-Bit N-Divider Range (Fractional)	Fractional nominal divide ratio varies (-3 / +4) dynamically max	20		524,283	
REF Input Characteristics					
Ref Input Frequency	Synthesizer phase noise can degrade by about 5dB when operating with a reference frequency near the low end of this range.	10	50	200	MHz
Ref Input Range	AC Coupled	1.5	2	3.3	Vpp
Ref Input Capacitance				5	pF
14-Bit R-Divider Range		1		16,383	
Phase Detector (PD)					
PD Frequency Fractional Feedback Mode	[1]	0.1		100	MHz
PD Frequency Fractional Feedforward Mode (and Register 6 [17:16] = 10)	[1]	0.1		80	MHz
PD Frequency Integer Mode	[1]	0.1		125	MHz

Note 1: This maximum phase detector frequency can only be achieved if the minimum N value is respected. eg. In the case of fractional feedback mode, the maximum PFD rate = $f_{vco}/20$ or 100MHz, whichever is less.

**FRACTIONAL-N PLL WITH
INTEGRATED VCO, 3365 - 3705 MHz**
Electrical Specifications (Continued)

Parameter	Condition	Min.	Typ.	Max.	Units
Charge Pump					
Output Current		0.02		2.54	mA
Charge Pump Gain Step Size (5-Bits)			20		μ A
PD/Charge Pump SSB Phase Noise	50 MHz Ref, Input Referred,				
1 kHz			-141		dBc/Hz
10 kHz	add 1 dB for fractional		-149		dBc/Hz
100 kHz	add 3 dB for fractional		-153		dBc/Hz
Logic Inputs					
VIH Input High Voltage		DVDD3V-0.4		DVDD3V	V
VIL Input Low Voltage		0		0.4	V
Logic Outputs					
VOH Output High Voltage		DVDD3V-0.4		DVDD3V	V
VOL Output Low Voltage		0		0.4	V
Power Supply Voltages					
Analog 3.3V Supplies	AVDD, VCCHF, VCCPS, VCCPD, RVDD	3.0	3.3	3.5	V
Digital Supply	DVDD3V	3.0	3.3	3.5	V
Analog 5V Supplies	VPPCP, VDDCP, VCC1, VCC2	4.8	5	5.2	V
Power Supply Currents					
+5V Analog Charge Pump	VPPCP, VDDCP		5.3		mA
+5V VCO Core and PLL Buffer	VCC2		56		mA
+5V VCO RF Buffer	VCC1		36		mA
+3.3V Analog	AVDD, VCCHF, VCCPS, VCCPD, RVDD		45		mA
+3.3V Digital	DVDD3V		6.5		mA
Power Down - Crystal Off	Reg 01h=0, Crystal Not Clocked		10		μ A
Power Down - Crystal On, 100 MHz	Reg 01h=0, Crystal Clocked 100 MHz		10	200	μ A
Power on Reset					
Typical Reset Voltage on DVDD			700		mV
DVDD Voltage for No Reset		1.5			V
Power on Reset Delay			250		μ s
VCO Open Loop SSB Phase Noise at fo = 1.75 GHz					
10 kHz Offset			-91		dBc/Hz
100 kHz Offset			-111		dBc/Hz
1 MHz Offset			-136		dBc/Hz
10 MHz Offset			-157		dBc/Hz
100 MHz Offset			-169		dBc/Hz
Closed Loop Phase Noise PLL + VCO at fo = 3.5 GHz					
Integer, 50 MHz PFD	1 kHz Offset		-102		dBc/Hz
Integer, 50 MHz PFD	10 kHz Offset		-107		dBc/Hz
Integer, 50 MHz PFD	100 kHz Offset		-107		dBc/Hz



FRACTIONAL-N PLL WITH INTEGRATED VCO, 3365 - 3705 MHz

Electrical Specifications (Continued)

Parameter	Condition	Min.	Typ.	Max.	Units
Fractional, 50 MHz PFD	1 kHz Offset		-197		dBc/Hz
Fractional, 50 MHz PFD	10 kHz Offset		-102		dBc/Hz
Fractional, 50 MHz PFD	100 kHz Offset		-102		dBc/Hz
Figure of Merit	Normalized 1 Hz				
Integer Mode	Measured w/ 50 MHz PD at 30 kHz Offset		-229		dBc/Hz
Fractional Mode	Measured w/ 50 MHz PD at 30 kHz Offset		-227		dBc/Hz

Closed Loop Integer Mode, SSB Phase Noise

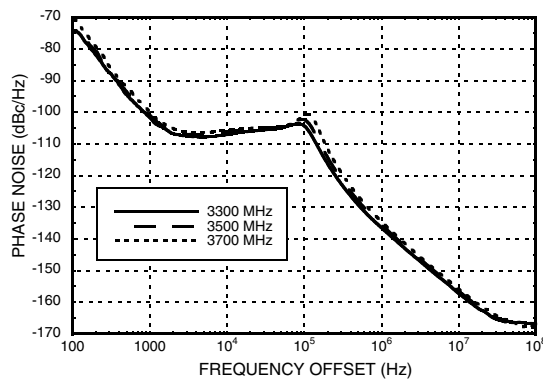

Typical Closed Loop Fractional Mode, SSB Phase Noise [1]

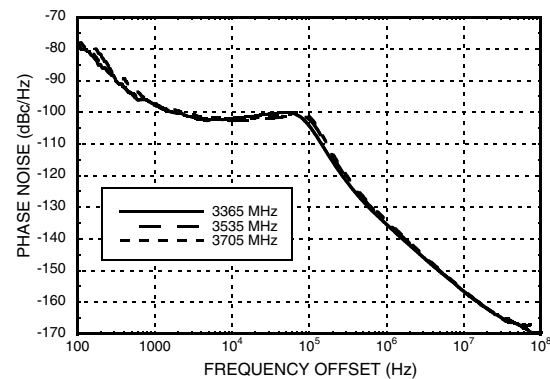

VCO Free Running SSB Phase Noise

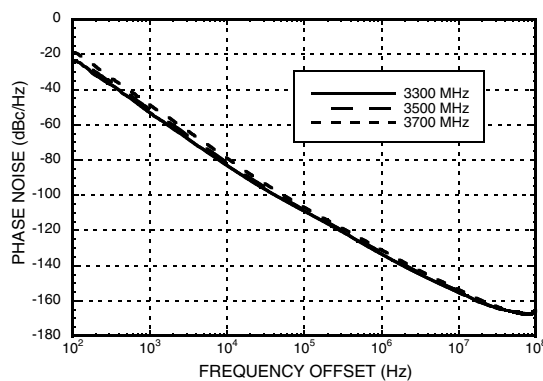

Typical Tuning Curves vs. Switch Position

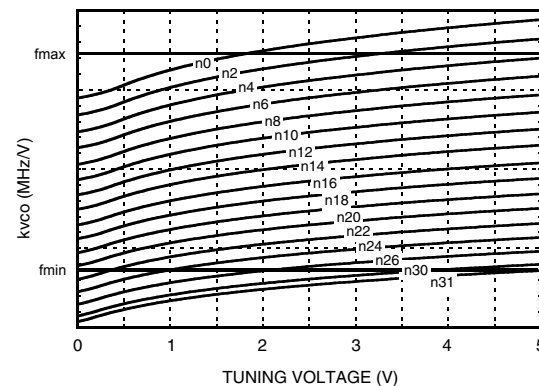

[1] Fractional Mode, 50 MHz Crystal, R=1, ~80 kHz Loop BW, (Loop filter values: Contact factory for component values) 2mA Charge Pump, -385µA Offset.

FRACTIONAL-N PLL WITH INTEGRATED VCO, 3365 - 3705 MHz

Typical VCO Tuning Voltage After Calibration vs. VCO Frequency & CAP Setting [2]

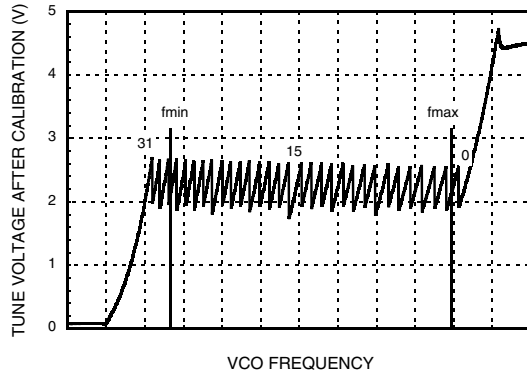

Typical VCO Sensitivity vs. VCO Tune Voltage & CAP Setting @ fo [2]

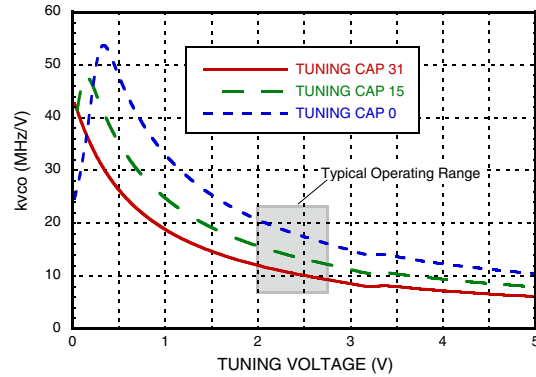

Typical Output Power

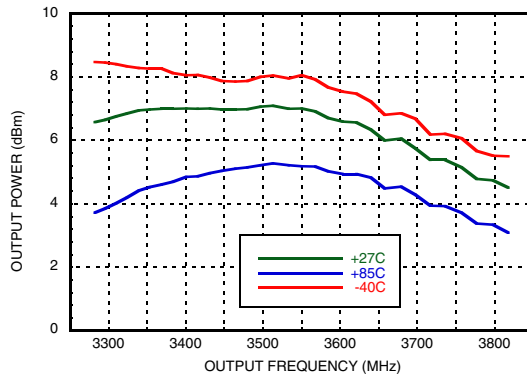
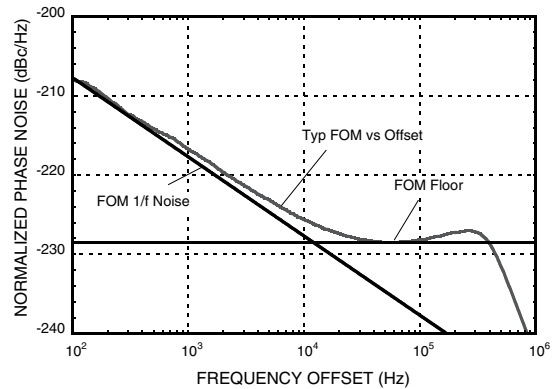

Figure of Merit



7

PLLS w/ INTEGRATED VCO - SMT

[1] Fractional Mode, 50 MHz Crystal, R=1, ~80 kHz Loop BW. (Loop filter values: Contact factory for component values) 2mA Charge Pump, -385µA Offset.

[2] The CAP setting is the digitally selectable VCO tank capacitor setting. This feature allows the nominal center frequency of the VCO to be adjusted by switching in/out VCO tank capacitors.



FRACTIONAL-N PLL WITH INTEGRATED VCO, 3365 - 3705 MHz

Pin Descriptions

Pin Number	Function	Description
1	AVDD	DC Power Supply for analog circuitry.
2, 5, 6, 8, 9, 11 - 14, 18 - 22, 24, 26, 29, 34, 37, 38	N/C	The pins are not connected internally; however, all data shown herein was measured with these pins connected to RF/DC ground externally.
3	VPPCP	Power Supply for charge pump analog section
4	CP	Charge Pump Output
7	VDDCP	Power Supply for the charge pump digital section
10	RVDD	Reference Supply
15	XREFP	Reference Oscillator Input
16	DVDD3V	DC Power Supply for Digital (CMOS) Circuitry
17	CEN	Chip Enable. Connect to logic high for normal operation.
23	VTUNE	VCO Varactor. Tuning Port Input.
25	VCC2	VCO Analog Supply 2
27	VCC1	VCO Analog Supply 1
28	RFOUT	RF Doubler Output
30	SEN	PLL Serial Port Enable (CMOS) Logic Input
31	SDI	PLL Serial Port Data (CMOS) Logic Input
32	SCK	PLL Serial Port Clock (CMOS) Logic Input
33	LD_SDO	Lock Detect, or Serial Data, or General Purpose (CMOS) Logic Output (GPO)
35	VCCHF	DC Power Supply for Analog Circuitry
36	VCCPS	DC Power Supply for Analog Prescaler
39	VCCPD	DC Power Supply for Phase Detector
40	BIAS	External bypass decoupling for precision bias circuits. Note: 1.920V \pm 20mV reference voltage (BIAS) is generated internally and cannot drive an external load. Must be measured with 10G Ω meter such as Agilent 34410A, normal 10M Ω DVM will read erroneously.

FRACTIONAL-N PLL WITH INTEGRATED VCO, 3365 - 3705 MHz

Absolute Maximum Ratings

AVDD, RVDD, DVDD3V, VCCPD, VCCHF, VCCPS	-0.3V to +3.6V
VPPCP, VDDCP, VCC1	-0.3V to +5.8V
VCC2	-0.3V to +5.5V
Operating Temperature	-40°C to +85°C
Storage Temperature	-65°C to 125°C
Maximum Junction Temperature	125 °C
Thermal Resistance (R _{TH}) (junction to ground paddle)	20 °C/W
Reflow Soldering	
Peak Temperature	260°C
Time at Peak Temperature	40 sec
ESD Sensitivity (HBM)	Class 1B

Stresses above those listed under Absolute Maximum Ratings may cause permanent damage to the device. This is a stress rating only; functional operation of the device at these or any other conditions above those indicated in the operational section of this specification is not implied. Exposure to absolute maximum rating conditions for extended periods may affect device reliability.

Outline Drawing

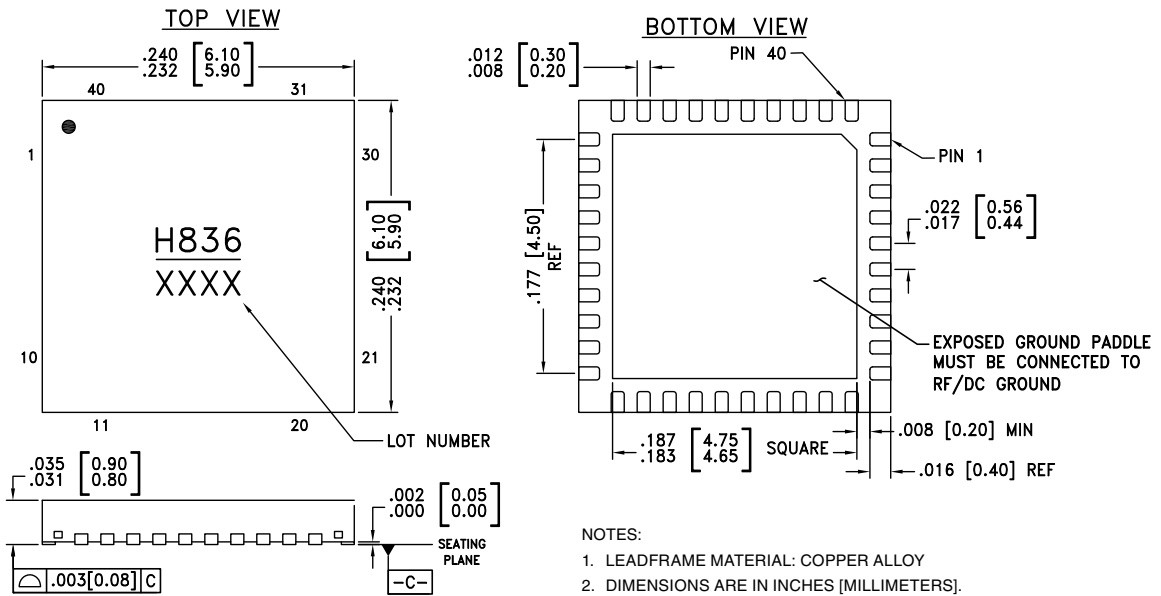

Package Information

Part Number	Package Body Material	Lead Finish	MSL Rating	Package Marking ^[1]
HMC836LP6CE	RoHS-compliant Low Stress Injection Molded Plastic	100% matte Sn	MSL1	H836 XXXX

[1] 4-Digit lot number XXXX



FRACTIONAL-N PLL WITH INTEGRATED VCO, 3365 - 3705 MHz

Evaluation PCB

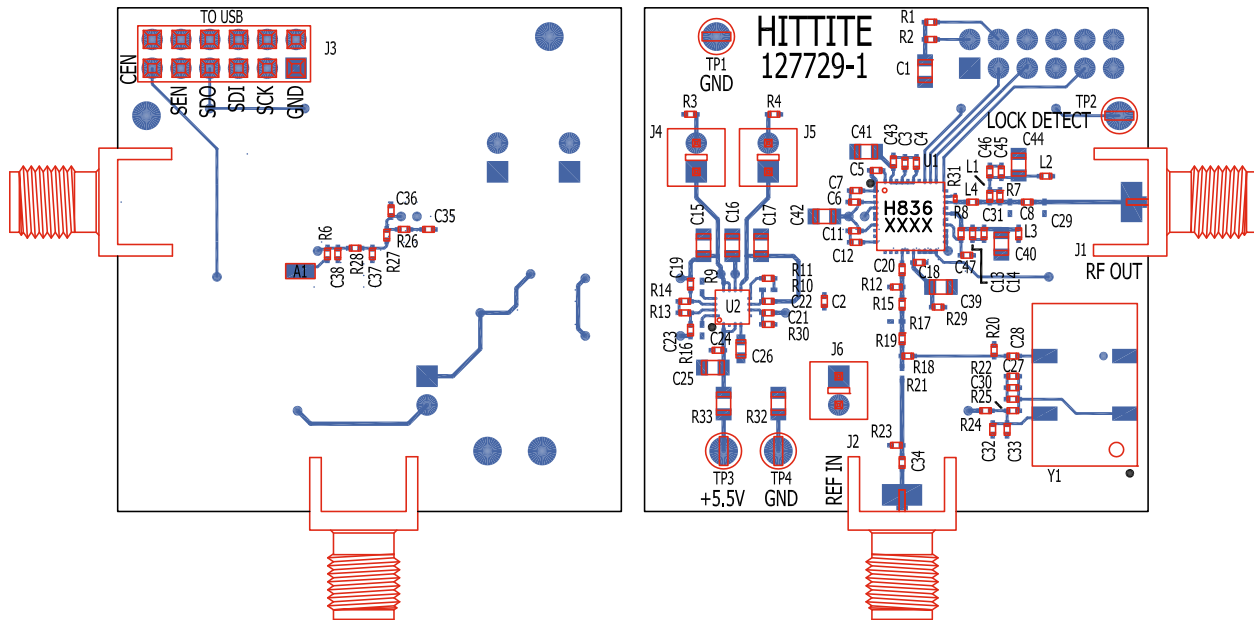

The circuit board used in the final application should use RF circuit design techniques. Signal lines should have 50 Ohm impedance while the package ground leads and exposed paddle should be connected directly to the ground plane similar to that shown. A sufficient number of via holes should be used to connect the top and bottom ground planes. The evaluation circuit board shown is available from Hittite upon request.

Evaluation PCB Schematic

To view this [Evaluation PCB Schematic](#) please visit www.hittite.com and choose HMC836LP6CE from the "Search by Part Number" pull down menu to view the product splash page.

List of Materials for Evaluation PCB 127832 [1]

Item	Description
J1, J2	PCB Mount SMA RF Connector
J3	Dual Row Terminal Strip
J4 - J6	Connector Header
C1, C15 - C17, C25	10 μ F Capacitor, 0805 Pkg.
C2, C3, C6, C7, C11, C12, C14, C18, C27, C43, C45	0.47 μ F Capacitor, 0402 Pkg.
C4, C13	22 pF Capacitor, 0402 Pkg.
C5, C33	1000 pF Capacitor, 0402 Pkg.
C8	8.2 pF Capacitor, 0402 Pkg.
C19 - C24, C28, C30, C32, C34	0.1 μ F Capacitor, 0402 Pkg.
C26	1.0 μ F Capacitor, 0603 Pkg.
C35	3300 pF Capacitor, 0402 Pkg.
C36	270 pF Capacitor, 0402 Pkg.
C37, C38	68 pF Capacitor, 0402 Pkg.
C39 - C42, C44	4.7 μ F Tantalum Capacitor, 0805 Pkg
C46	27 pF Capacitor, 0402 Pkg.
C47	47 pF Capacitor, 0402 Pkg.
R1, R2, R11, R15, R18, R19, R21, R24	Zero Ohm Resistor, 0402 Pkg.
R3, R4	1 Ohm Resistor, 0402 Pkg.
R6	1 MOhm Resistor, 0402 Pkg.
R8	22 Ohm Resistor, 0402 Pkg.
R12, R20, R29	51 Ohm Resistor, 0402 Pkg.
R13, R14, R30	220 kOhm Resistor, 0402 Pkg.
R22, R25	20 kOhm Resistor, 0402 Pkg.
R26 - R28	1k Ohm Resistor, 0402 Pkg.
R32, R33	0 Ohm Resistor, 0805 Pkg.
L1	10 nH Inductor, 0402 Pkg.
L2	68 Ohm Resistor, 0402 Pkg.
L3	4.7 nH Inductor, 0402 Pkg.
L4	1.5 nH Inductor, 0402 Pkg.
TP3, TP4	Test Point PC Compact SMT
U1	HMC836LP6CE PLL with Integrated VCO
U2	HMC860LP3E Low Noise Quad Linear Regulator
Y1	3.3V, 50 MHz VCXO Crystal Oscillator
PCB [2]	127729 Evaluation Board

[1] Reference this number when ordering complete evaluation PCB

[2] Circuit Board Material: Rogers 4350 or Arlon 25FR and FR4



**FRACTIONAL-N PLL WITH
INTEGRATED VCO, 3365 - 3705 MHz**

Notes: