

ISOLATED DC/DC CONVERTERS

48 Vdc Input 12 Vdc /18 A Output

bel
POWER PRODUCTS

0RQB-D0T12x

RoHS Compliant

Rev.B

- Fixed Frequency (300 kHz)
- Isolated
- High Efficiency
- High Power Density
- Input Under Voltage Lockout
- Basic Insulation
- Output Over Voltage Latch Off
- Over Temperature Protection
- SCP/OCP
- Low Cost
- Remote On/Off
- TUV Certified to EN 60950-1



Description

The 0RQB-D0T12x are isolated dc/dc converters that operate from a nominal 48 Vdc source. These units will provide up to 216 W of output power from a nominal 48 Vdc input. These units are designed to be highly efficient and low cost. Features include remote on/off, over current protection, input under-voltage and output over voltage protection. These converters are provided in an industry standard quarter brick package.

Part Selection

Output Voltage	Input Voltage	Max. Output Current	Max. Output Power	Typical Efficiency	Model Number Active High	Model Number Active Low
12 Vdc	36 Vdc - 75 Vdc	18 A	216 W	92.5%	0RQB-D0T120	0RQB-D0T12L

- Notes:** 1. Add "G" suffix at the end of the model number to indicate Tray Packaging.
2. All part numbers above indicate RoHS 6. Change the second letter "R" to "7" for RoHS 5 part numbers.

Absolute Maximum Ratings

Parameter	Min	Typ	Max	Notes
Input Voltage (continuous)	-0.3 V	-	80 V	
Remote On/Off	-0.3 V	-	18 V	
I/O Isolation Voltage	-	-	2250 V	
Ambient Temperature	-40 °C	-	85 °C	
Storage Temperature	-55 °C	-	125 °C	

Note: All specifications are typical at 25 °C unless otherwise stated.

Input Specifications

Parameter	Min	Typ	Max	Notes
Input Voltage	36 V	48 V	75 V	
Input Current (no load)	-	110 mA	200 mA	
Input Current (full load)	-	-	7 A	
Remote Off Input Current	-	4 mA	7 mA	
Input Reflected Ripple Current (pk-pk)	-	20 mA	-	With simulated source impedance of 12 uH, 5 Hz to 20 MHz; use a 220uF/100 V electrolytic capacitor with ESR = 1 ohm max. at 200 kHz
Input Reflected Ripple Current (rms)	-	5 mA	-	
I ² t Inrush Current Transient	-	TBD	-	
Turn-on Voltage Threshold	-	34 V	35 V	
Turn-off Voltage Threshold	31 V	33 V	-	

Note: All specifications are typical at nominal input, full load at 25 °C unless otherwise stated

ISOLATED DC/DC CONVERTERS

48 Vdc Input 12 Vdc /18 A Output



Output Specifications

Parameter	Min	Typ	Max	Notes	
Output Voltage Set Point	11.76 V	12 V	12.24 V	V _{in} =48 V, I _o =100%Load	
Line Regulation	-	20 mV	-		
Load Regulation	-	30 mV	-		
Regulation Over Temperature (-40 °C to 85 °C)	-	0.02%Vo/°C	-		
Output Current	0 A	-	18 A		
Current Limit Threshold	19 A	21 A	27 A		
Ripple and Noise (rms)	-	30 mV	50 mV	0 - 20 MHz BW, with 1 uF ceramic load capacitor and a 10uF Tantalum capacitor at the output	
Ripple and Noise (pk-pk)	-	85 mV	150 mV		
Turn on Time	-	10 mS	-		
Overshoot at Turn on	-	0%	5%		
Output Capacitance	-	-	6000 uF		
Transient Response					
50% ~ 75% Max Load	Overshoot	V _o =12 V	-	300 mV	di/dt=0.1A/us, V _{in} =48Vdc, T _a =25 °C, with 1 uF ceramic capacitor and a 10uF Tantalum capacitor at the output.
	Settling Time		-	100 uS	
75% ~ 50% Max Load	Overshoot		-	300 mV	
	Settling Time		-	100 uS	

Note: All specifications are typical at nominal input, full load at 25 °C unless otherwise stated.

General Specifications

Parameter	Min	Typ	Max	Notes
Efficiency	89%	92.5%	-	V _{in} =48 V, full load
Switching Frequency	270 kHz	300 kHz	330 kHz	
Isolation Capacitance	-	3000 pF	-	
Input to Output Isolation Voltage	-	-	2250 V	
Remote Sense Compensation	-	-	10%	The voltage increased by trim and sense should not exceed 110%V _{out} .
Output Voltage Trim Range	90%	-	110%	
Over Temperature Protection	-	130 °C	-	
Over Voltage Protection	13.5 V	-	15 V	V _{in} =48 V, I _o =full load, Latch mode
MTBF	1,632,203 hours			Calculated Per Bell Core SR-332 (V _{in} =48 V, V _o =12 V, I _o =14.4 A, 300LFM forced air flow, T _a = 25 °C)
Dimensions				
Inches (L x W x H)	2.30 x 1.45 x 0.394			
Millimeters (L x W x H)	58.42 x 36.83 x 10.00			
Weight	-	48 g	-	

Note: All specifications are typical at 25 °C unless otherwise stated.

ISOLATED DC/DC CONVERTERS

48 Vdc Input 12 Vdc /18 A Output



Control Specifications

Parameter	Min	Typ	Max	Notes	
Remote On/Off					
Signal Low (Unit On)	Active Low	-0.3 V	-	0.8 V	The Remote On/Off pin is open, Unit off.
Signal High (Unit Off)		2.4 V	-		
Signal Low (Unit Off)	Active High	-0.3 V	-	0.8 V	The Remote On/Off pin is open, Unit on
Signal High (Unit On)		2.4 V	-		

Output Trim Equations

Equations for calculating the trim resistor are shown below. The Trim Down resistor should be connected between the Trim pin and GND pin. The Trim Up resistor should be connected between the Trim pin and the Vout pin. Only one of the resistors should be used for any given application.

$$R_{trimdown} = \frac{511}{|\delta|} - 10.22 [k\Omega]$$

$$R_{trimup} = \frac{(100 + \delta) \cdot V_o \cdot 5.11 - 625}{1.225 \cdot \delta} - 10.22 [k\Omega]$$

Note:

$$\delta = \frac{(V_o - req - V_o)}{V_o} \times 100 [\%]$$

Output voltage $V_o = 12.004$ V

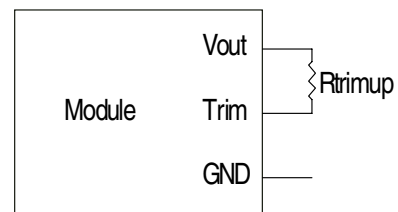
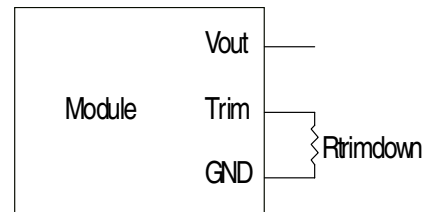

Efficiency Data

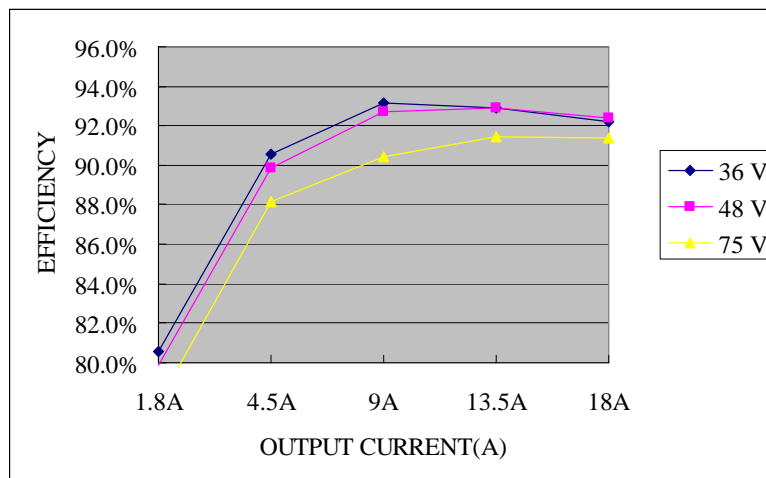

ISOLATED DC/DC CONVERTERS

48 Vdc Input 12 Vdc /18 A Output



Thermal Derating Curves

With maximum junction temperature of semiconductors derated to 120°C.

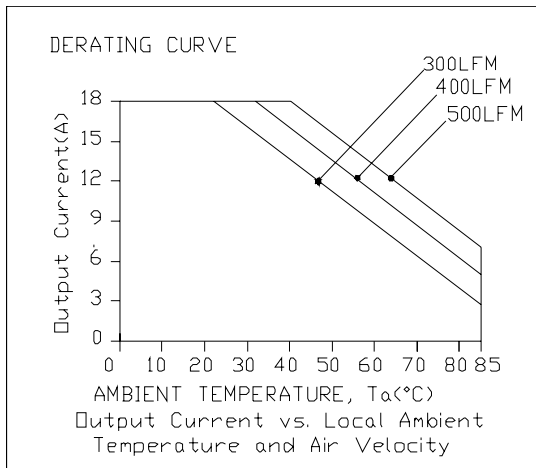

Vin=75 V

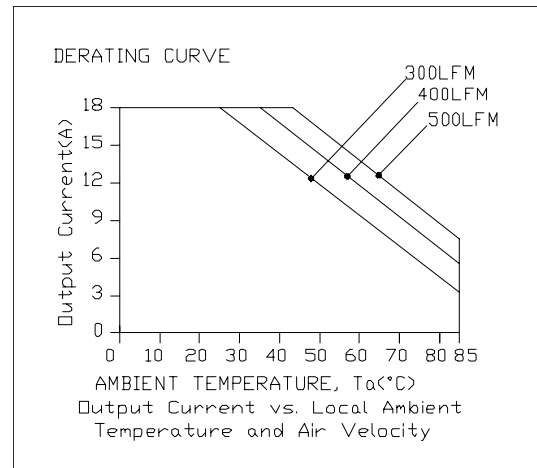

Vin=48 V

Ripple and Noise Waveform

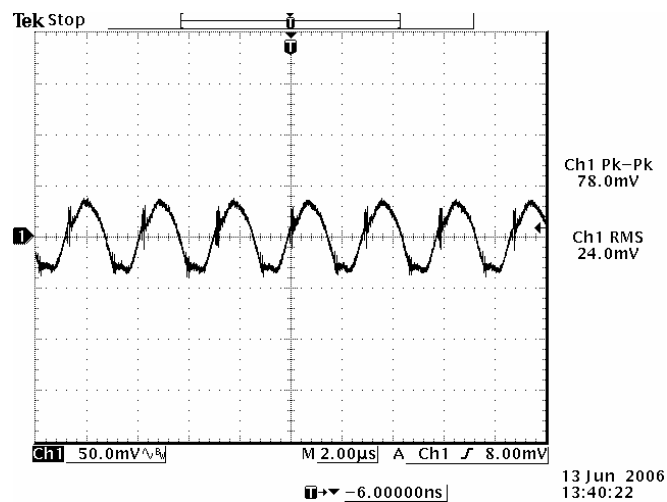

Note: Ripple and noise at full load, 48 Vdc input, 12 Vdc/18 A output, and with a 1 μ F ceramic cap and a 10 μ F tantalum cap at the output, $T_a=25$ deg C.

ISOLATED DC/DC CONVERTERS

48 Vdc Input 12 Vdc /18 A Output



Transient Response Waveforms

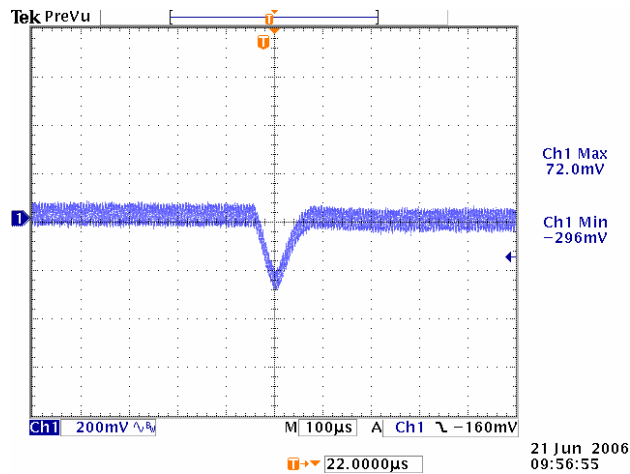

Vout= 12 V 50%-75% Load Transients at Vin=48 V@Ta=25°C

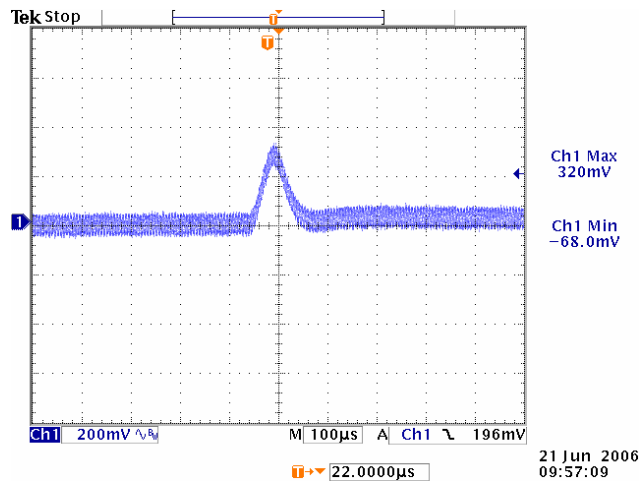

Vout= 12 V 75%-50% Load Transients at Vin=48 V@Ta=25°C

Note: Transients response at $di/dt=0.1$ A/ μ s, Vin=48 Vdc, Ta=25 °C, with 1 μ F ceramic capacitor and a 10 μ F Tantalum capacitor at the output.

ISOLATED DC/DC CONVERTERS

48 Vdc Input 12 Vdc /18 A Output



Mechanical Outline

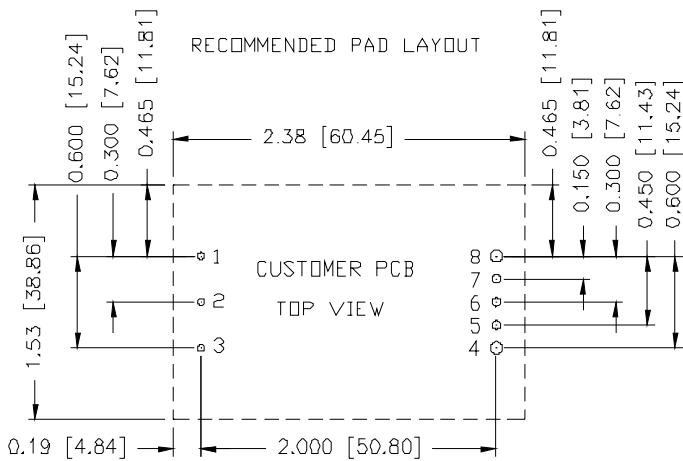
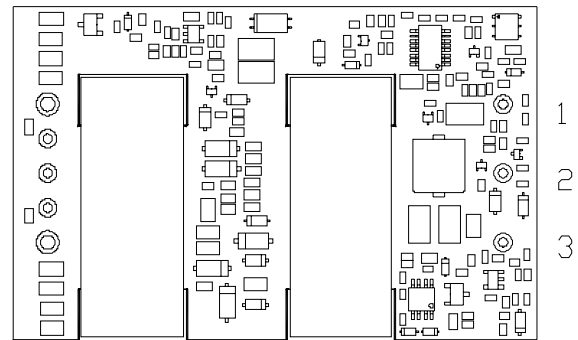
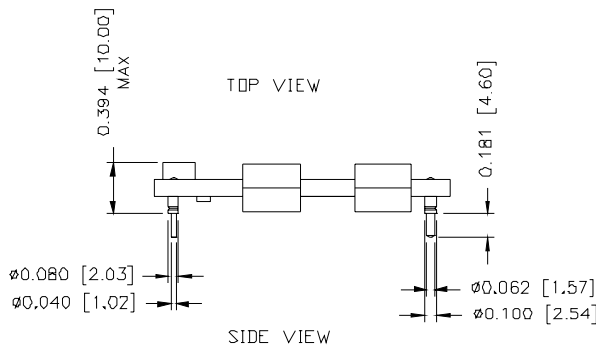
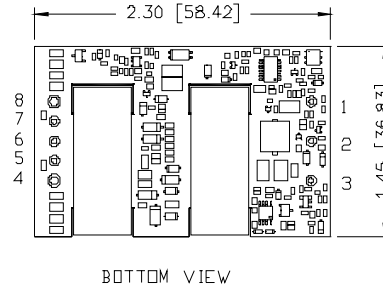
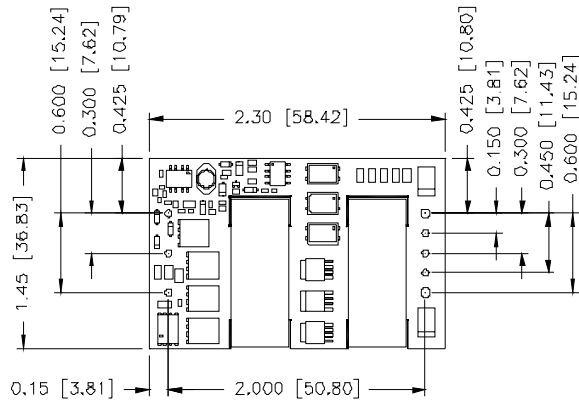

1,2,3,5,6,7 $\varnothing 0.047$ HOLE SIZE, $\varnothing 0.08$ min PAD SIZE
 4,8 $\varnothing 0.07$ HOLE SIZE, $\varnothing 0.10$ min PAD SIZE

BOTTOM VIEW

Pin Connections

Pin	Function	Pin Size
1	Vin(+)	0.040"
2	On/Off	0.040"
3	Vin(-)	0.040"
4	Vo(-)	0.062"
5	RS(-)	0.040"
6	Trim	0.040"
7	RS(+)	0.040"
8	Vo(+)	0.062"

ISOLATED DC/DC CONVERTERS

48 Vdc Input 12 Vdc /18 A Output



INSTALLATION INSTRUCTION

- 1) The DC-DC Converter can be operated at an ambient temperature up to 80°C maximum.
- 2) The DC-DC Converter is a built-in component. During installation into certain equipment the relevant requirements of EN 60950-1:2001 + A11 and IEC 60950-1:2001 shall be maintained.
- 3) The creepage distances, clearances and thickness of insulation between unearthed hazardous voltage input and SELV output circuits have complied with basic insulation requirements according to EN 60950-1:2001 + A11 and IEC 60950-1:2001.
- 4) The output ratings as shown on the label must not be exceeded.
- 5) The equipment is to be supplied from a DC source which is separated from AC mains by double or reinforced insulation, or by basic insulation and suitable earthing providing equivalent protection.
- 6) The equipment is intended to be installed into a class I or class II system, when installed into class I system, protective earth has to be reliably identified and suitable external protection devices have to be provided in the final system.
- 7) The equipment shall be installed with an external forced air-cooling according to installation instruction. The airflow direction is towards the side of the equipment.

RoHS Compliance

Complies with the European Directive 2002/95/EC, calling for the elimination of lead and other hazardous substances from electronic products.



©2008 Bel Fuse Inc. Specifications subject to change without notice. 010208

CORPORATE

Bel Fuse Inc.
206 Van Vorst Street
Jersey City, NJ 07302
Tel 201-432-0463
Fax 201-432-9542
www.belfuse.com

FAR EAST

Bel Fuse Ltd.
8F/ 8 Luk Hop Street
San Po Kong
Kowloon, Hong Kong
Tel 852-2328-5515
Fax 852-2352-3706
www.belfuse.com

EUROPE

Bel Fuse Europe Ltd.
Preston Technology Management Centre
Marsh Lane, Suite G7, Preston
Lancashire, PR1 8UD, U.K.
Tel 44-1772-556601
Fax 44-1772-888366
www.belfuse.com