

## ISOLATED DC/DC CONVERTERS

48 Vdc Input, 12 Vdc/8.35 A, 5 Vdc/20 A, 3.3 Vdc/25 A, 1.2-2.5 Vdc/30 A Outputs

**bel**  
POWER PRODUCTS

### 0RQB-C0U Series RoHS Compliant PRELIMINARY Rev.A

- Isolated
- High Efficiency
- High Power Density
- Low Cost
- Input Under Voltage Lockout
- Fixed Frequency (285 kHz)
- Input Over Voltage Lockout
- Active Low/High (Option)
- Output Over Voltage Shutdown
- OCP/SCP
- Over Temperature Protection
- Remote On/Off
- Output Voltage Trim
- Positive/Negative Remote Sense
- Basic Isolation
- Safety Approval to UL60950-1 (UL/cUL)

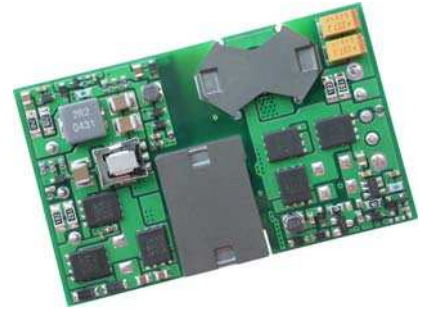

### Description

The 0RQB-C0U Series are isolated dc/dc converters that operate from a nominal 48 Vdc source. These units will provide up to 100 W of output power from a nominal 48 Vdc input. These units are designed to be highly efficient and low cost. Typical efficiency of 12 Vdc output at 48 Vdc input at full load is 91%. Features include remote on/off, over current protection and under-voltage lockout. These converters are provided in an industry standard quarter brick package.

### Part Selection

Output Voltage	Input Voltage	Max. Output Current	Max. Output Power	Typical Efficiency	Model Number Active High	Model Number Active Low
12 Vdc	18 Vdc - 75 Vdc	8.35 A	100 W	91%	0RQB-C0U120	0RQB-C0U12L
5.0 Vdc	18 Vdc - 75 Vdc	20 A	100 W	90%	0RQB-C0U050	0RQB-C0U05L
3.3 Vdc	18 Vdc - 75 Vdc	25 A	82.5 W	90%	0RQB-C0U033	0RQB-C0U03L
2.5 Vdc	18 Vdc - 75 Vdc	30 A	75 W	89.5%	0RQB-C0U025	0RQB-C0U02L
1.8 Vdc	18 Vdc - 75 Vdc	30 A	54 W	85%	0RQB-C0UV80	0RQB-C0UV8L
1.5 Vdc	18 Vdc - 75 Vdc	30 A	45 W	83%	0RQB-C0UV50	0RQB-C0UV5L
1.2 Vdc	18 Vdc - 75 Vdc	30 A	36 W	80%	0RQB-C0UV20	0RQB-C0UV2L

- Notes:** 1. Add "G" suffix at the end of the model number to indicate Tray Packaging.  
2. All part numbers above indicate RoHS 6. Change the second letter "R" to "7" for RoHS 5 part numbers.

### Absolute Maximum Ratings

Parameter	Min	Typ	Max	Notes
Input Voltage (continuous)	-0.3 V	-	80 V	No Operating
	-	-	75 V	Operating
Remote On/Off	-0.3 V	-	18 V	
I/O Isolation Voltage	-	-	2000 V	
Ambient Temperature	-40 °C	-	85 °C	
Storage Temperature	-55 °C	-	125 °C	

**Note:** All specifications are typical at nominal input, full load at 25 °C unless noted.

## ISOLATED DC/DC CONVERTERS

48 Vdc Input, 12 Vdc/8.35 A, 5 Vdc/20 A, 3.3 Vdc/25 A, 1.2-2.5 Vdc/30 A Outputs



### Input Specifications

Parameter	Min	Typ	Max	Notes
Input Voltage	18 V	48 V	75 V	
Input Current (full load)				
Vo=12 V	-	-	7.0 A	
Vo=5.0 V	-	-	7.0 A	
Vo=3.3 V	-	-	6.0 A	
Vo=2.5 V	-	-	5.5 A	
Vo=1.8 V	-	-	4.0 A	
Vo=1.5 V	-	-	3.5 A	
Vo=1.2 V	-	-	3.0 A	
Input Current (no load)	-	100 mA	180 mA	
Remote Off Input Current		10 mA	15 mA	
Input Reflected Ripple Current (pk-pk)	-	20 mA	40 mA	Tested with simulated source impedance of 10 uH, 5 Hz to 20 MHz BW; use a 0.47 uF/100 V ceramic cap and a 100 uF /100 V electrolytic cap with ESR = 1 ohm max. at 200 kHz at 25 °C.
Input Reflected Ripple Current (rms)	-	5 mA	10 mA	
I <sup>2</sup> t Inrush Current Transient	-	0.05 A <sup>2</sup> s	0.1 A <sup>2</sup> s	
Turn-on Voltage Threshold	16.5 V	17.0 V	17.5 V	
Turn-off Voltage Threshold	15.5 V	16.0 V	16.5 V	
Input over voltage Lockout	76 V	78 V	80 V	

**Note:** All specifications are typical at nominal input, full load at 25 °C unless noted.

### Output Specifications

Parameter	Min	Typ	Max	Notes
Output Voltage Set Point				Vin=48 V, Io=50% full load
Vo=12 V	11.820 V	12.00 V	12.180 V	
Vo=5.0 V	4.925 V	5.00 V	5.075 V	
Vo=3.3 V	3.251 V	3.30 V	3.360 V	
Vo=2.5 V	2.455 V	2.50 V	2.545 V	
Vo=1.8 V	1.773 V	1.80 V	1.827 V	
Vo=1.5 V	1.448 V	1.50 V	1.523 V	
Vo=1.2 V	1.182 V	1.20 V	1.218 V	
Line Regulation				
Vo=12 V	-	±24 mV	±120 mV	
Vo=5.0 V	-	±10 mV	±25 mV	
Vo=3.3 V	-	±4 mV	±15 mV	
Vo=2.5 V	-	±4 mV	±10 mV	
Vo=1.2 V-1.8 V	-	±3 mV	±6 mV	
Load Regulation				
Vo=12 V	-	±30 mV	±80 mV	
Vo=5.0 V	-	±10 mV	±25 mV	
Vo=3.3 V -2.5 V	-	±8 mV	±15 mV	
Vo=1.2 V -1.8 V	-	±5 mV	±10 mV	
Regulation Over Temperature (-40 °C to +85 °C)				
Vo=12 V	-	±60 mV	±100 mV	
Vo=5.0 V	-	±40 mV	±65 mV	
Vo=3.3 V	-	±30 mV	±50 mV	
Vo=2.5 V	-	±20 mV	±50 mV	
Vo=1.8 V-1.2 V	-	±15 mV	±30 mV	

# ISOLATED DC/DC CONVERTERS

48 Vdc Input, 12 Vdc/8.35 A, 5 Vdc/20 A, 3.3 Vdc/25 A, 1.2-2.5 Vdc/30 A Outputs



## Output Specifications (continued)

Parameter	Min	Typ	Max	Notes			
Output Current Range							
Vo=12 V	0 A	-	8.35 A				
Vo=5.0 V	0 A	-	20 A				
Vo=3.3 V	0 A	-	25 A				
Vo=1.2 V -2.5 V	0 A	-	30 A				
Current Limit Threshold							
Vo=12 V	9.2 A	10.5 A	13 A				
Vo=5.0 V	24 A	26 A	30 A				
Vo=3.3 V	27 A	32 A	35 A				
Vo=2.5 V	35 A	40 A	45 A				
Vo=1.2 V -1.8 V	-	36 A	-				
Short Circuit Surge Transient	-	3 A <sup>2</sup> s	5 A <sup>2</sup> s				
Vin=48 V ; Ripple and Noise (rms)				Test conditions: 0-20 MHz BW, with a 1 uF ceramic capacitor and a 10 uF Tantalum capacitor at the output.			
Vo=12 V	-	30 mV	50 mV				
Vo=5.0 V	-	25 mV	40 mV				
Vo=3.3 V -2.5 V	-	20 mV	40 mV				
Vo=1.2 V -1.8 V	-	15 mV	30 mV				
Vin=24 V ; Ripple and Noise (rms)							
Vo=12 V	-	25 mV	40 mV				
Vo=5.0 V	-	20 mV	30 mV				
Vo=3.3 V	-	15 mV	25 mV				
Vo=1.2 V -2.5 V	-	10 mV	20 mV				
Vin=48 V ; Ripple and Noise (pk-pk)							
Vo=12 V	-	100 mV	150 mV				
Vo=5.0 V	-	75 mV	120 mV				
Vo=3.3 V -2.5 V	-	50 mV	100 mV				
Vo=1.2 V -1.8 V	-	40 mV	80 mV				
Vin=24 V ; Ripple and Noise (pk-pk)							
Vo=12 V	-	75 mV	120 mV				
Vo=5.0 V	-	50 mV	100 mV				
Vo=3.3 V	-	35 mV	70 mV				
Vo=2.5 V	-	30mV	60 mV				
Vo=1.2 V -1.8 V	-	25 mV	50 mV				
Turn on Time	10 mS	-	100 mS				
Overshoot at Turn on	-	0%	5%				
Output Capacitance							
Vo=12.0 V	0 uF	-	1200 uF				
Vo=5.0 V	0 uF	-	6800 uF				
Vo=3.3 V	0 uF	-	15000 uF				
Vo=1.2 V-2.5 V	0 uF	-	20000 uF				
<b>Transient Response</b>							
50% ~ 75% Max Load	Overshoot	Vo=12.0 V	-	360 mV	480 mV	Test conditions: di/dt = 0.1 A/uS, Vin=48 V, with a 1 uF ceramic capacitor and a 10 uF Tantalum capacitor at the output.	
	Settling Time		-	100 uS	250 uS		
75% ~ 50% Max Load	Overshoot		-	360 mV	480mV		
	Settling Time		-	150 uS	250 uS		
50% ~ 75% Max Load	Overshoot		Vo=5.0 V	-	200 mV		300 mV
	Settling Time			-	100 uS		150 uS
75% ~ 50% Max Load	Overshoot	-		200 mV	300 mV		
	Settling Time	-		100 uS	150 uS		
50% ~ 75% Max Load	Overshoot	Vo=3.3 V		-	150 mV		200 mV
	Settling Time			-	100 uS		100 uS
75% ~ 50% Max Load	Overshoot		-	150 mV	200 mV		
	Settling Time		-	100 uS	100 uS		

## ISOLATED DC/DC CONVERTERS

48 Vdc Input, 12 Vdc/8.35 A, 5 Vdc/20 A, 3.3 Vdc/25 A, 1.2-2.5 Vdc/30 A Outputs



### Output Specifications (continued)

Parameter		Min	Typ	Max	Notes	
<b>Transient Response</b>						
50% ~ 75% Max Load	Overshoot	Vo=2.5 V,	-	150 mV	200 mV	Test conditions: di/dt = 0.1 A/uS, Vin=48 V, with a 1 uF ceramic capacitor and a 10 uF Tantalum capacitor at the output.
	Settling Time		-	85 uS	100 uS	
75% ~ 50% Max Load	Overshoot		-	150 mV	200 mV	
	Settling Time		-	85 uS	100 uS	
50% ~ 75% Max Load	Overshoot	Vo=1.2 V-1.8 V	-	50 mV	80 mV	
	Settling Time		-	100 uS	150 uS	
75% ~ 50% Max Load	Overshoot		-	50 mV	80 mV	
	Settling Time		-	100 uS	150 uS	

**Note:** All specifications are typical at nominal input, full load at 25 °C unless noted.

### General Specifications

Parameter		Min	Typ	Max	Notes
Efficiency	Vo=12 V	88%	91%	-	Vin=48 V, full load , Ta=25 °C
	Vo=5.0 V	88%	90%	-	
	Vo=3.3 V	88%	90%	-	
	Vo=2.5 V	88%	89.5%	-	
	Vo=1.8 V	-	85%	-	
	Vo=1.5 V	-	83%	-	
	Vo=1.2 V	-	80%	-	
Efficiency	Vo=12 V	-	92%	-	Vin=24 V, full load , Ta=25 °C
	Vo=5.0 V	-	91%	-	
	Vo=3.3 V	89%	91%	-	
	Vo=2.5 V	-	87%	-	
	Vo=1.8 V	-	85%	-	
	Vo=1.5 V	-	83%	-	
	Vo=1.2 V	-	80%	-	
Switching Frequency	240 kHz	285 kHz	320 kHz		
Isolation capacitance	-	1500 pF	-		
Input to Output Isolation Voltage	-	-	2000 V		
Remote Sense Compensation	-	-	10% Vo	The total voltage increased by trim and remote sense should not exceed 10%Vo.	
Output Voltage Trim Range	80% Vo	-	110% Vo		
Over Temperature Protection	-	125 °C	-		
Over Voltage Protection	-	130% Vo	-	Vin=48V, full load, Hiccup mode	
MTBF	TBD			Calculated Per Bell Core SR-332 (Io = Nominal; Ta = 25 °C)	
Dimensions	Inches millimeters	2.30 x 1.45 x 0.395 58.42 x 36.83 x 10.03			
Weight		-	40 g	-	

**Note:** All specifications are typical at nominal input, full load at 25 °C unless noted.

## ISOLATED DC/DC CONVERTERS

48 Vdc Input, 12 Vdc/8.35 A, 5 Vdc/20 A, 3.3 Vdc/25 A, 1.2-2.5 Vdc/30 A Outputs



### Control Specifications

Parameter		Min	Typ	Max	Notes
<b>Remote On/Off</b>					
Signal Low (Unit On)	Active Low	-0.3 V	-	0.8 V	0RQB-C0UxxL. The remote on/off pin open, Unit off.
Signal High (Unit Off)		2.4 V	-	18 V	
Signal Low (Unit Off)	Active High	-0.3 V	-	0.8 V	0RQB-C0Uxx0. The remote on/off pin open, Unit on.
Signal High (Unit On)		2.4 V	-	18 V	
Current Sink		0 mA	-	0.75 mA	

### Output Trim Equations

Equations for calculating the trim resistor are shown below (Unit: kΩ). The Trim Down resistor should be connected between the Trim pin and Ground pin. The Trim Up resistor should be connected between the Trim pin and the Vout. Only one of the resistors should be used for any given application.

#### 1) For $V_o=1.5\text{ V} - 12\text{ V}$ :

$$R_{trimdown} = \frac{511}{|\delta|} - 10.22$$

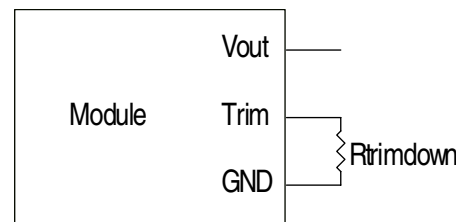

$$R_{trimup} = \frac{(100 + \delta) \cdot V_o \cdot 5.11 - 626}{1.225 \cdot \delta} - 10.22$$

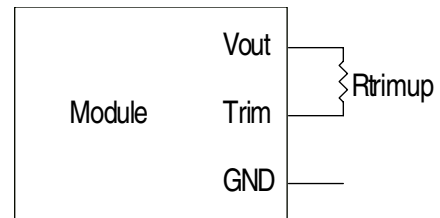

#### 2) For $V_o=1.2\text{ V}$ :

$$R_{trimdown} = \frac{511}{|\delta|} - 10.22$$

$$R_{trimup} = \frac{(100 + \delta) \cdot V_o \cdot 5.11 - 313}{0.6125 \cdot \delta} - 10.22$$

#### Notes:

$$\delta = \frac{(V_o_{req} - V_o)}{V_o} \times 100[\%]$$

$V_o_{req}$ =Desired (trimmed) output voltage [V];  $V_o$ =output voltage

# ISOLATED DC/DC CONVERTERS

48 Vdc Input, 12 Vdc/8.35 A, 5 Vdc/20 A, 3.3 Vdc/25 A, 1.2-2.5 Vdc/30 A Outputs



## Efficiency Data

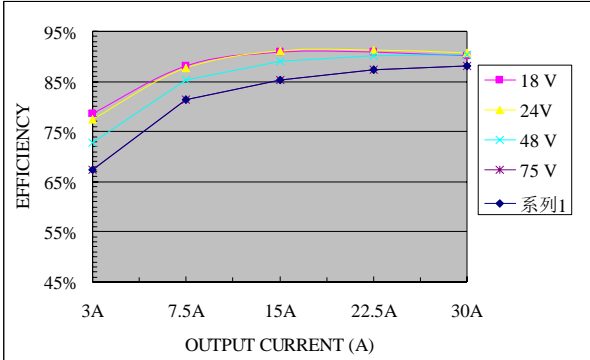

Vo=2.5 V

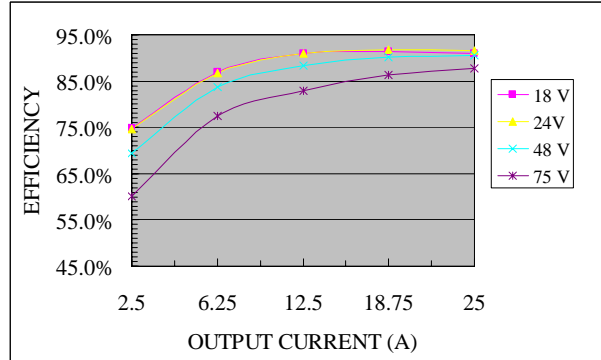

Vo=3.3 V

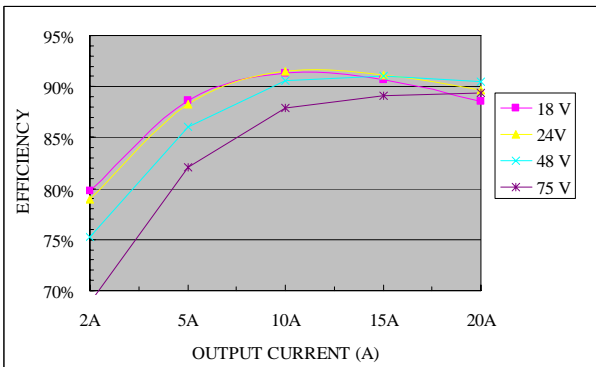

Vo=5.0 V

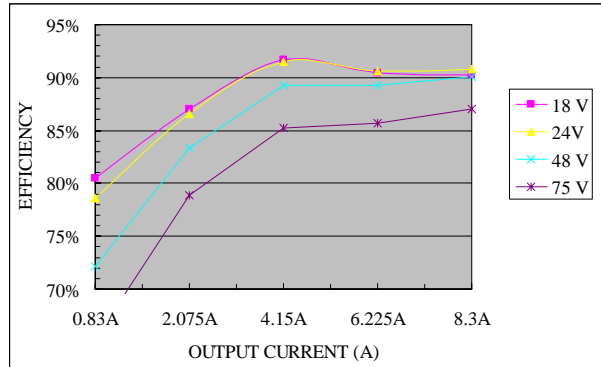

Vo=12 V

## Thermal Derating Curves

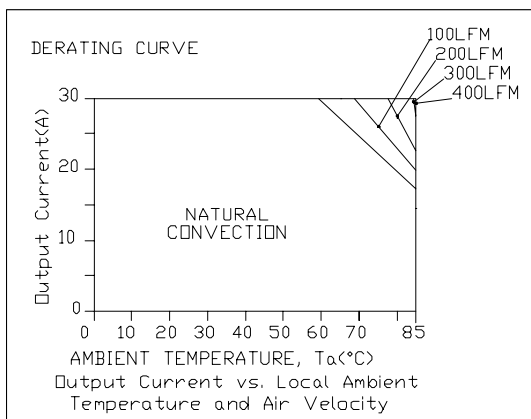

Vo=2.5 V, Vin=48 V

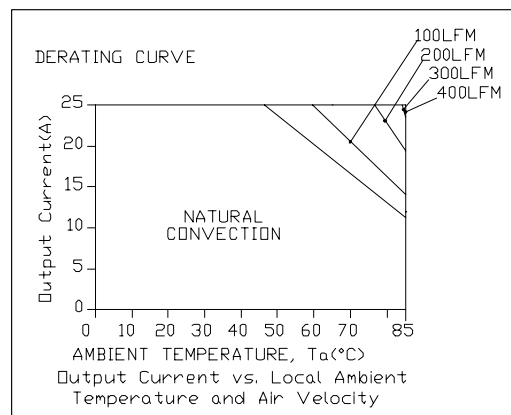

Vo=3.3 V, Vin=48 V

# ISOLATED DC/DC CONVERTERS

48 Vdc Input, 12 Vdc/8.35 A, 5 Vdc/20 A, 3.3 Vdc/25 A, 1.2-2.5 Vdc/30 A Outputs



## Thermal Derating Curves (continued)

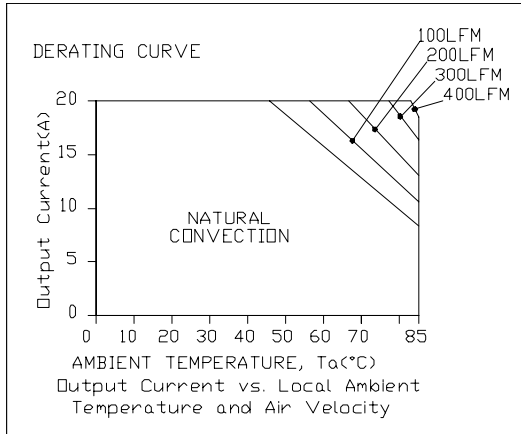

Vo=5.0 V, Vin=48 V

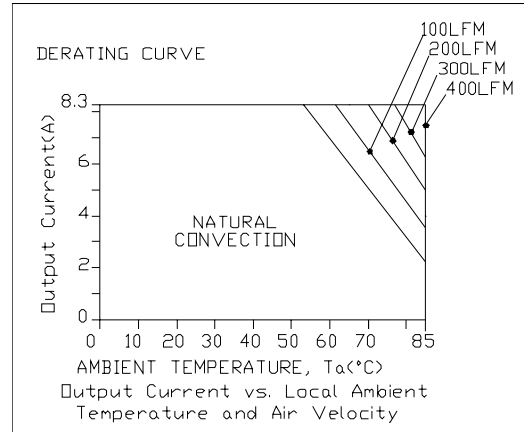

Vo=12 V, Vin=48 V

## Ripple and Noise Waveforms

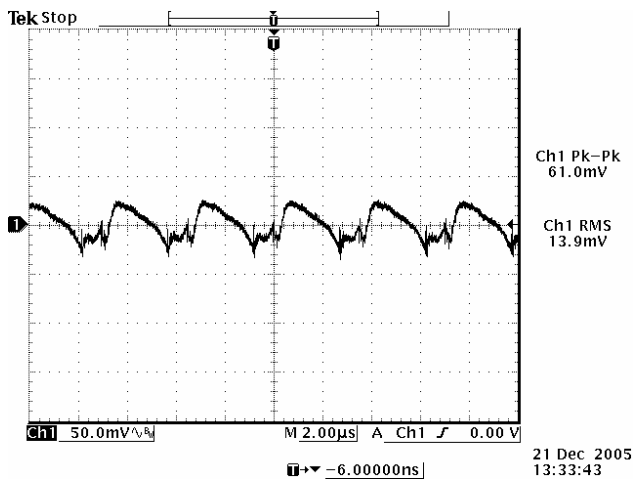

2.5 V/30 A output

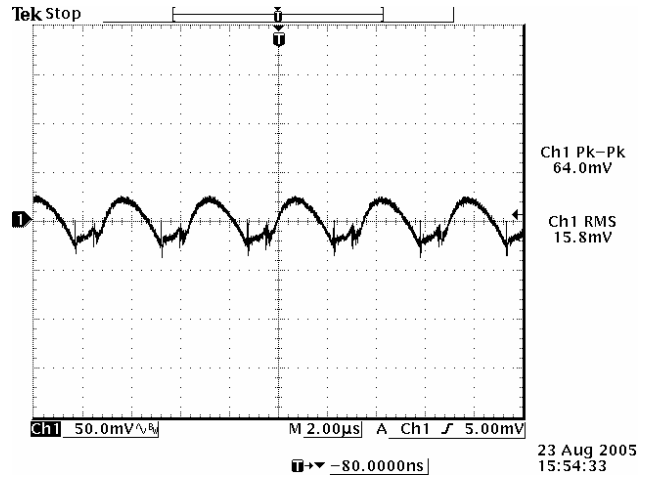

3.3 V/25 A output

# ISOLATED DC/DC CONVERTERS

48 Vdc Input, 12 Vdc/8.35 A, 5 Vdc/20 A, 3.3 Vdc/25 A, 1.2-2.5 Vdc/30 A Outputs



## Ripple and Noise Waveforms (continued)

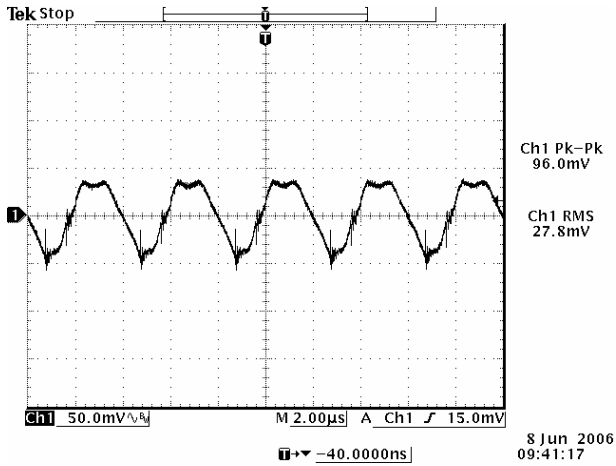

5.0 V/20 A output

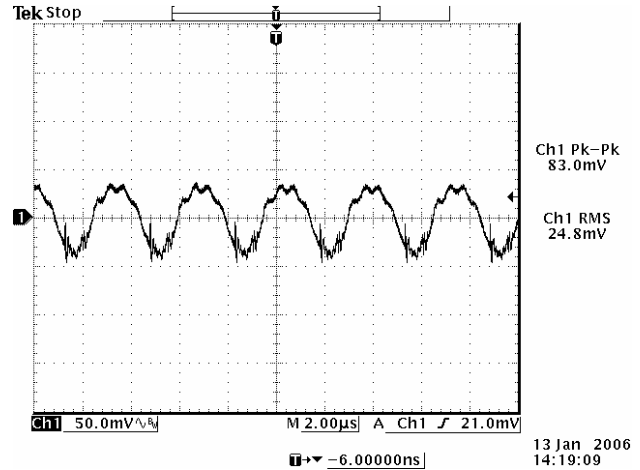

12 V/8.35 A output

**Note:** Ripple and noise at full load, 48 V input, with a 1 uF ceramic capacitor and a 10 uF tantalum capacitor at the output, and Ta=25 deg C.

## Transient Response Waveforms

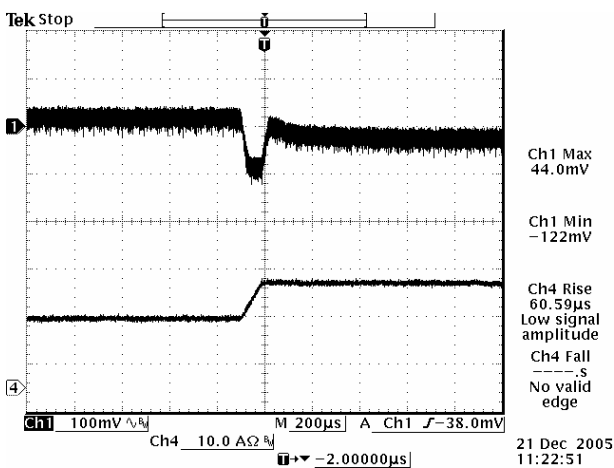

Vout= 2.5 V 50%-75% Load Transients at Vin=48 V

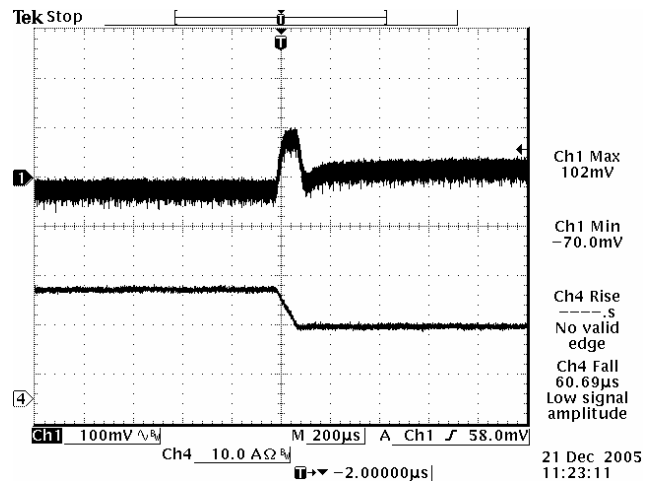

Vout= 2.5 V 75%-50% Load Transients at Vin=48 V

# ISOLATED DC/DC CONVERTERS

48 Vdc Input, 12 Vdc/8.35 A, 5 Vdc/20 A, 3.3 Vdc/25 A, 1.2-2.5 Vdc/30 A Outputs



## Transient Response Waveforms (continued)

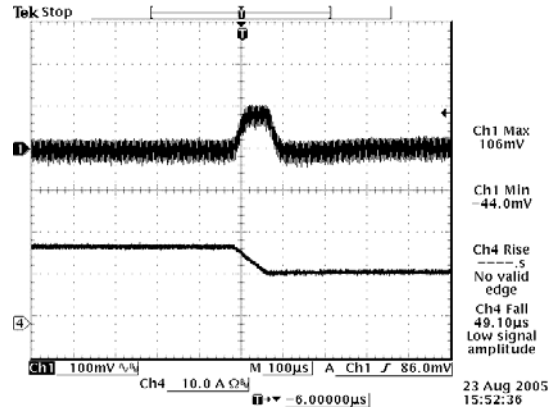
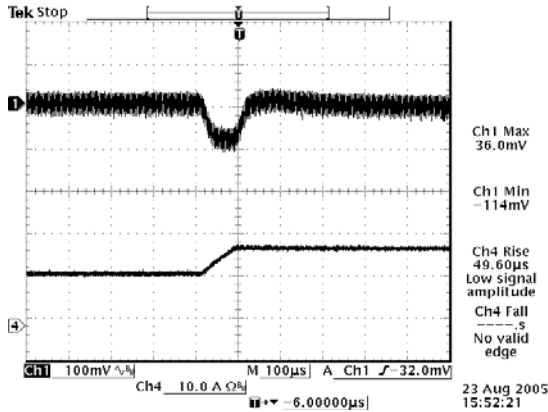

Vout= 3.3 V 50%-75% Load Transients at Vin=48 V

Vout= 3.3 V 75%-50% Load Transients at Vin=48 V

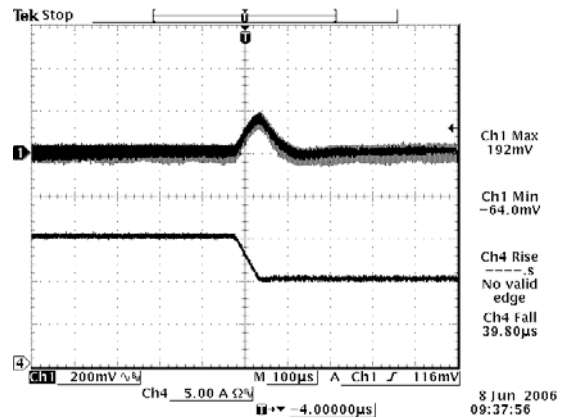
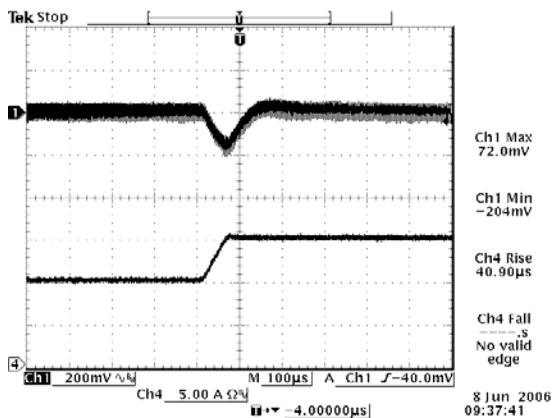

Vout= 5.0 V 50%-75% Load Transients at Vin=48 V

Vout= 5.0 V 75%-50% Load Transients at Vin=48 V

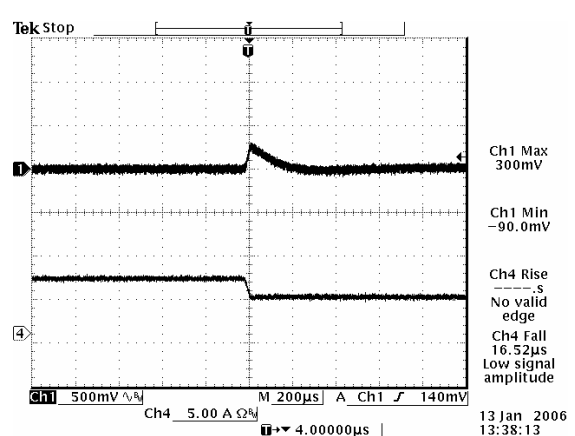
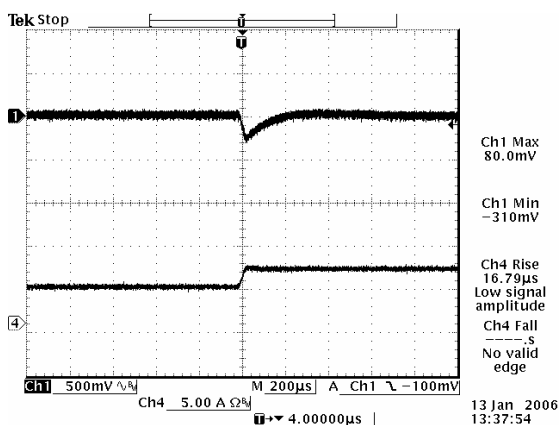

Vout= 12 V 50%-75% Load Transients at Vin=48 V

Vout= 12 V 75%-50% Load Transients at Vin=48 V

**Note:** Transients at  $di/dt = 0.1 \text{ A}/\mu\text{S}$ ,  $V_{in}=48 \text{ V}$ , with a  $1 \mu\text{F}$  ceramic capacitor and a  $10 \mu\text{F}$  Tantalum capacitor at the output,  $T_a=25 \text{ deg C}$ .

# ISOLATED DC/DC CONVERTERS

48 Vdc Input, 12 Vdc/8.35 A, 5 Vdc/20 A, 3.3 Vdc/25 A, 1.2-2.5 Vdc/30 A Outputs



## Mechanical Outline

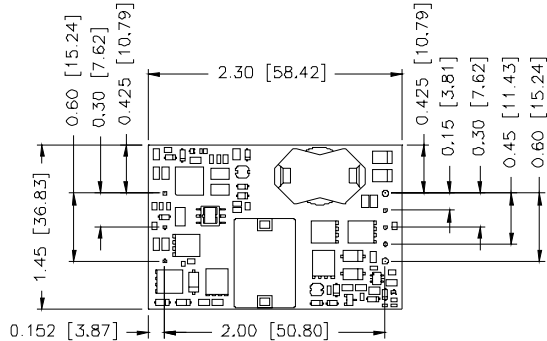

TOP VIEW

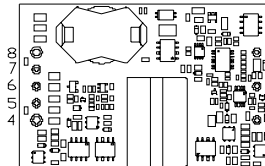

BOTTOM VIEW

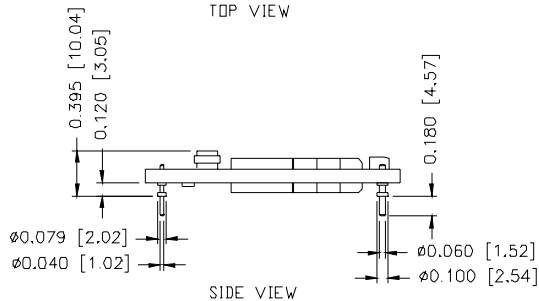

SIDE VIEW

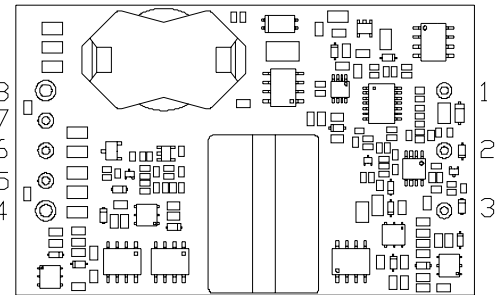

BOTTOM VIEW

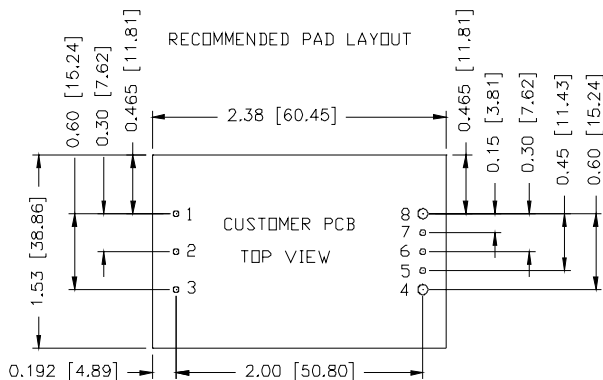

1,2,3,5,6,7 Ø0.047 HOLE SIZE, Ø0.08 min PAD SIZE  
4,8 Ø0.07 HOLE SIZE, Ø0.10 min PAD SIZE

## Pin Connections

Pin	Function	Pin Size
1	Vin (+)	0.04"
2	Remote On/Off	0.04"
3	Vin (-)	0.04"
4	Vout (-)	0.062"
5	Remote Sense (-)	0.04"
6	Trim	0.04"
7	Remote Sense (+)	0.04"
8	Vout (+)	0.062"

## RoHS Compliance

Complies with the European Directive 2002/95/EC, calling for the elimination of lead and other hazardous substances from electronic products.



©2007 Bel Fuse Inc. Specifications subject to change without notice. 030307

### CORPORATE

**Bel Fuse Inc.**  
206 Van Vorst Street  
Jersey City, NJ 07302  
Tel 201-432-0463  
Fax 201-432-9542  
[www.belfuse.com](http://www.belfuse.com)

### FAR EAST

**Bel Fuse Ltd.**  
8F/ 8 Luk Hop Street  
San Po Kong  
Kowloon, Hong Kong  
Tel 852-2328-5515  
Fax 852-2352-3706  
[www.belfuse.com](http://www.belfuse.com)

### EUROPE

**Bel Fuse Europe Ltd.**  
Preston Technology Management Centre  
Marsh Lane, Suite G7, Preston  
Lancashire, PR1 8UD, U.K.  
Tel 44-1772-556601  
Fax 44-1772-888366  
[www.belfuse.com](http://www.belfuse.com)