

## ISOLATED DC/DC CONVERTERS

48 Vdc Input 1.2 Vdc - 12 Vdc / 8.33 A - 30 A Output, 1/8 Brick

**bel**  
POWER PRODUCTS

### 0RCY-85T Series RoHS Compliant Rev.B

- Isolated
- High Efficiency
- High Power Density
- Fixed Frequency (300 kHz)
- Low Cost
- Input Under Voltage Lockout
- Safety Approval to UL60950-1 (UL/cUL)
- Pre-Bias Start Up
- Output Over Voltage Shutdown
- OCP/SCP
- Over Temperature Protection
- Remote On/Off
- Output Voltage Trim
- Positive/Negative Remote Sense
- Basic Insulation
- Pin Length (option)

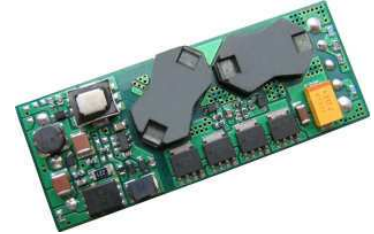

### Description

The 0RCY-85T Series are isolated dc/dc converters that operate from a nominal 48 Vdc source. These units provide up to 100 W of output power. These units are designed to be highly efficient and cost-effective. Features include remote on/off, short circuit protection, over current protection, over temperature protection, input under voltage lockout, and output over voltage protection. These converters are provided in a compact, 1/8 brick industry standard package.

### Part Selection

Output Voltage	Input Voltage	Max. Output Current	Max. Output Power	Typical Efficiency	Model Number Active High	Model Number Active Low
12.0 V	36 V - 75 V	8.33 A	100 W	91%	0RCY-85T120	0RCY-85T12L
5.0 V	36 V - 75 V	20 A	100 W	91%	0RCY-85T050	0RCY-85T05L
3.3 V	36 V - 75 V	25 A	85 W	90%	0RCY-85T033	0RCY-85T03L
2.5 V	36 V - 75 V	25 A	62.5 W	89%	0RCY-85T025	0RCY-85T02L
1.8 V	36 V - 75 V	25 A	45 W	88%	0RCY-85TV80	0RCY-85TV8L
1.5 V	36 V - 75 V	30 A	45 W	86%	0RCY-85TV50	0RCY-85TV5L
1.2 V	36 V - 75 V	30 A	36 W	84%	0RCY-85TV20	0RCY-85TV2L

**Notes:** 1. Change the last character to "M" to indicate 0.18" pin length and active low.

2. Add "G" suffix at the end of the model number to indicate Tray Packaging.

3. All part numbers above indicate RoHS 6. Change the second letter "R" to "7" for RoHS 5 part numbers.

### Absolute Maximum Ratings

Parameter	Min	Typ	Max	Notes
Input Voltage (continuous)	-0.3 V	-	80 V	
Input Voltage Transient Protection	-	-	100 V	Operating for 100mS
Remote On/Off	-0.3 V	-	18 V	
I/O Isolation Voltage	-	-	2000 V	
Ambient Temperature	-40 °C	-	100 °C	
Storage Temperature	-55 °C	-	125 °C	

## ISOLATED DC/DC CONVERTERS

48 Vdc Input 1.2 Vdc - 12 Vdc / 8.33 A - 30 A Output, 1/8 Brick



### Input Specifications

Parameter	Min	Typ	Max	Notes
Input Voltage	36 V	48 V	75 V	
Input Current (full load)				
Vo=12.0 V	-	-	3.2 A	
Vo=5.0 V	-	-	3.2 A	
Vo=3.3 V	-	-	2.8 A	
Vo=2.5 V	-	-	2.2 A	
Vo=1.8 V	-	-	1.7 A	
Vo=1.5 V	-	-	1.7 A	
Vo=1.2 V	-	-	1.5 A	
Input Current (no load)				
Vo=12.0 V	-	65 mA	90 mA	
Vo=5.0 V	-	65 mA	90 mA	
Vo=3.3 V	-	60 mA	80 mA	
Vo=2.5 V	-	55 mA	75 mA	
Vo=1.8 V	-	50 mA	70 mA	
Vo=1.5 V	-	40 mA	60 mA	
Vo=1.2 V	-	35 mA	50 mA	
Remote Off Input Current		6 mA	12 mA	
Input Reflected Ripple Current (pk-pk)	-	12 mA	24 mA	Tested with simulated source impedance of 10 uH, 5 Hz to 20 MHz; use a 100 uF/100 V electrolytic capacitor with ESR = 1 ohm max. at 200 kHz at 25 °C.
Input Reflected Ripple Current (rms)	-	2 mA	4 mA	
I <sup>2</sup> t Inrush Current Transient	-	0.01 A <sup>2</sup> s	0.02 A <sup>2</sup> s	
Turn-on Voltage Threshold	32 V	34 V	35 V	
Turn-off Voltage Threshold	30 V	32 V	33 V	

### Output Specifications

Parameter	Min	Typ	Max	Notes
Output Voltage Set Point				Vin=48 V, Io=50% full load, Ta=25 °C.
Vo=12.0 V	11.760 V	12.0 V	12.24 V	
Vo=5.0 V	4.925 V	5.0 V	5.075 V	
Vo=3.3 V	3.250 V	3.3 V	3.350 V	
Vo=2.5 V	2.463 V	2.5 V	2.538 V	
Vo=1.8 V	1.773 V	1.8 V	1.827 V	
Vo=1.5 V	1.477 V	1.5 V	1.523 V	
Vo=1.2 V	1.182 V	1.2 V	1.218 V	
Line Regulation				
Vo=12.0 V-3.3 V	-	±2 mV	±5 mV	
Vo=1.2 V-2.5 V	-	±1 mV	±3 mV	
Load Regulation				
Vo=12.0 V	-	±8 mV	±16 mV	
Vo=5.0 V	-	±8 mV	±16 mV	
Vo=3.3 V	-	±6 mV	±12 mV	
Vo=2.5 V	-	±4 mV	±8 mV	
Vo=1.8 V	-	±3 mV	±6 mV	
Vo=1.5 V	-	±3 mV	±6 mV	
Vo=1.2 V	-	±2 mV	±4 mV	

# ISOLATED DC/DC CONVERTERS

48 Vdc Input 1.2 Vdc - 12 Vdc / 8.33 A - 30 A Output, 1/8 Brick



## Output Specifications (continued)

Parameter	Min	Typ	Max	Notes		
Regulation Over Temperature (-40 °C to +85 °C)						
Vo=12.0 V	-	±50 mV	±75 mV			
Vo=5.0 V	-	±50 mV	±75 mV			
Vo=3.3 V	-	±20 mV	±40 mV			
Vo=2.5 V	-	±15 mV	±30 mV			
Vo=1.8 V	-	±15 mV	±30 mV			
Vo=1.5 V	-	±10 mV	±20 mV			
Vo=1.2 V	-	±10 mV	±20 mV			
Output Current						
Vo=12.0 V	0 A	-	8.33 A			
Vo=5.0 V	0 A	-	20 A			
Vo=3.3 V	0 A	-	25 A			
Vo=2.5 V	0 A	-	25 A			
Vo=1.8 V	0 A	-	25 A			
Vo=1.5 V	0 A	-	30 A			
Vo=1.2 V	0 A	-	30 A			
Current Limit Threshold						
Vo=12.0 V	10 A	13 A	16 A			
Vo=5.0 V	23 A	29 A	35 A			
Vo=3.3 V	30 A	36 A	42 A			
Vo=2.5 V	27 A	33 A	40 A			
Vo=1.8 V	27 A	33 A	40 A			
Vo=1.5 V	32 A	36 A	45 A			
Vo=1.2 V	32 A	36 A	45 A			
Short Circuit Surge Transient	-	3 A <sup>2</sup> s	5 A <sup>2</sup> s			
Ripple and Noise (rms)				Test conditions: 0-20 MHz BW, with a 1 uF ceramic capacitor and a 10 uF Tantalum capacitor at the output.		
Vo=12.0 V	-	30 mV	50 mV			
Vo=5.0 V	-	25 mV	50 mV			
Vo=1.2 V-3.3 V	-	15 mV	30 mV			
Ripple and Noise (pk-pk)				Test conditions: 0-20 MHz BW, with a 1 uF ceramic capacitor and a 10 uF Tantalum capacitor at the output.		
Vo=12.0 V	-	100 mV	150 mV			
Vo=5.0 V	-	80 mV	120 mV			
Vo=3.3 V	-	45 mV	90 mV			
Vo=1.2 V-2.5 V	-	40 mV	80 mV			
Turn on Time	-	-	30 mS			
Overshoot at Turn on	-	0%	5%			
Output Capacitance						
Vo=12.0 V	0 uF	-	1000 uF			
Vo=5.0 V	0 uF	-	10000 uF			
Vo=1.2 V-3.3 V	0 uF	-	20000 uF			
<b>Transient Response</b>						
25% ~ 50% Max Load	Overshoot	Vo=12.0 V	-	300 mV	400 mV	Test conditions: di/dt = 0.1 A/uS, Vin=48 V, with a 1 uF ceramic capacitor and a 10 uF Tantalum capacitor at the output.
	Settling Time		-	200 uS	300 uS	
50% ~ 25% Max Load	Overshoot		-	300 mV	400 mV	
	Settling Time		-	200 uS	300 uS	
25% ~ 50% Max Load	Overshoot	Vo=5.0 V	-	200 mV	300 mV	
	Settling Time		-	200 uS	300 uS	
50% ~ 25% Max Load	Overshoot		-	200 mV	300 mV	
	Settling Time		-	200 uS	300 uS	
25% ~ 50% Max Load	Overshoot	Vo=3.3 V	-	150 mV	200 mV	
	Settling Time		-	200 uS	300 uS	
50% ~ 25% Max Load	Overshoot		-	150 mV	200 mV	
	Settling Time		-	200 uS	300 uS	

## ISOLATED DC/DC CONVERTERS

48 Vdc Input 1.2 Vdc - 12 Vdc / 8.33 A - 30 A Output, 1/8 Brick



### Output Specifications (continued)

Parameter		Min	Typ	Max	Notes
<b>Transient Response</b>					
25% ~ 50% Max Load	Overshoot	Vo=2.5 V	-	150 mV	200 mV
	Settling Time		-	150 $\mu$ S	200 $\mu$ S
50% ~ 25% Max Load	Overshoot	Vo=2.5 V	-	150 mV	200 mV
	Settling Time		-	150 $\mu$ S	200 $\mu$ S
25% ~ 50% Max Load	Overshoot	Vo=1.8 V	-	140 mV	170 mV
	Settling Time		-	150 $\mu$ S	200 $\mu$ S
50% ~ 25% Max Load	Overshoot	Vo=1.8 V	-	140 mV	170 mV
	Settling Time		-	150 $\mu$ S	200 $\mu$ S
25% ~ 50% Max Load	Overshoot	Vo=1.5 V	-	130 mV	150 mV
	Settling Time		-	150 $\mu$ S	200 $\mu$ S
50% ~ 25% Max Load	Overshoot	Vo=1.5 V	-	130 mV	150 mV
	Settling Time		-	150 $\mu$ S	200 $\mu$ S
25% ~ 50% Max Load	Overshoot	Vo=1.2 V	-	120 mV	140 mV
	Settling Time		-	150 $\mu$ S	200 $\mu$ S
50% ~ 25% Max Load	Overshoot	Vo=1.2 V	-	120 mV	140 mV
	Settling Time		-	150 $\mu$ S	200 $\mu$ S

Test conditions: di/dt = 0.1 A/ $\mu$ S, Vin=48 V, with a 1  $\mu$ F ceramic capacitor and a 10  $\mu$ F Tantalum capacitor at the output.

**Note:** All specifications are typical at 25 °C unless otherwise stated.

### General Specifications

Parameter	Min	Typ	Max	Notes
Efficiency				
Vo=12.0 V	88%	91%	-	Vin=48V, Io=Io, max
Vo=5.0 V	88%	91%	-	
Vo=3.3 V	87%	90%	-	
Vo=2.5 V	86%	89%	-	
Vo=1.8 V	85%	88%	-	
Vo=1.5 V	83%	86%	-	
Vo=1.2 V	81%	84%	-	
Switching Frequency	270 kHz	300 kHz	330 kHz	
Isolation capacitance	-	1500 pF	-	
Output Voltage Trim Range				The total voltage increased by trim and remote sense should not exceed 10%Vo.
Vo=1.5 V-12 V	80% Vo	-	110% Vo	
Vo=1.2 V	90% Vo	-	110% Vo	
Remote Sense	-	-	10%	
Over Temperature Protection	-	125 °C	-	
Over Voltage Protection	-	130% Vo	-	Vin=48V, full load, in hiccup mode.
Pre-bias Voltage				
Vo=5.0 V	-	-	4.0 V	
Vo=3.3 V	-	-	1.4 V	
Vo=2.5 V	-	-	2.0 V	
Vo=1.8 V	-	-	1.4 V	
Vo=1.5 V	-	-	1.2 V	
Vo=1.2 V	-	-	0.9 V	
MTBF	1,583,176 hours			Calculated Per Bell Core SR-332 (Vin=48 V, Vo=3.3 V, Io=20 A, Ta = 25 °C)
Dimensions				
Inches (L x W x H)	2.30 x 0.896 x 0.395			
Millimeters (L x W x H)	58.42 x 22.76 x 10.03			
Weight	-	27 g	-	

**Note:** All specifications are typical at 25 °C unless otherwise stated.

## ISOLATED DC/DC CONVERTERS

48 Vdc Input 1.2 Vdc - 12 Vdc / 8.33 A - 30 A Output, 1/8 Brick

**bel**  
POWER PRODUCTS

### Control Specifications

Parameter	Min	Typ	Max	Notes	
<b>Remote On/Off</b>					
Signal Low (Unit On)	Active Low	-0.3 V	-	0.8 V	0RCY-85TxxL. The remote on/off pin open, Unit off.
Signal High (Unit Off)		2.4 V	-		
Signal Low (Unit Off)	Active High	-0.3 V	-	0.8 V	0RCY-85Txx0. The remote on/off pin open, Unit on.
Signal High (Unit On)		2.4 V	-		
Current Sink	0 mA	-	0.75 mA		

### Output Trim Equations

Equations for calculating the trim resistor are shown below. The Trim Down resistor should be connected between the Trim pin and Ground pin. The Trim Up resistor should be connected between the Trim pin and the Vout. Only one of the resistors should be used for any given application.

$$R_{\text{trim-down}} = \frac{511}{|\text{delta}|} - 10.22 [\text{k}\Omega]$$

**Vo=1.5 V-12 V:**

$$R_{\text{trim-up}} = \frac{(100 + \text{delta}) \cdot V_o \cdot 5.11 - 626}{1.225 \cdot \text{delta}} - 10.22 [\text{k}\Omega]$$

**Vo=1.2 V:**

$$R_{\text{trim-up}} = \frac{(100 + \text{delta}) \cdot V_o \cdot 5.11 - 313}{0.6125 \cdot \text{delta}} - 10.22 [\text{k}\Omega]$$

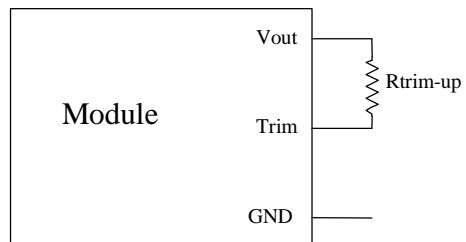
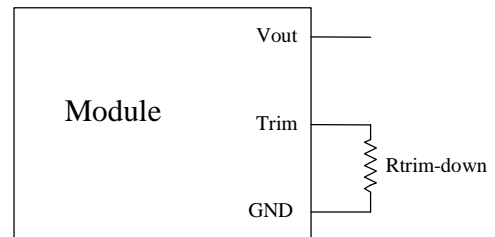

**Notes:**

$$\text{delta} = \frac{(V_o_{\text{req}} - V_o)}{V_o} \times 100 [\%]$$

$V_o_{\text{req}}$ =Desired (trimmed) output voltage [V]

Output voltage  $V_o$ =1.202 V for 1.2 V output;  $V_o$ =1.503 V for 1.5 V output;  $V_o$ =1.804 V for 1.8 V;  $V_o$ =2.505 V for 2.5 V output;  $V_o$ =3.308 V for 3.3 V output;  $V_o$ =5.000 V for 5.0 V;  $V_o$ =12.000 V for 12 V output

# ISOLATED DC/DC CONVERTERS

48 Vdc Input 1.2 Vdc - 12 Vdc / 8.33 A - 30 A Output, 1/8 Brick



## Efficiency Data

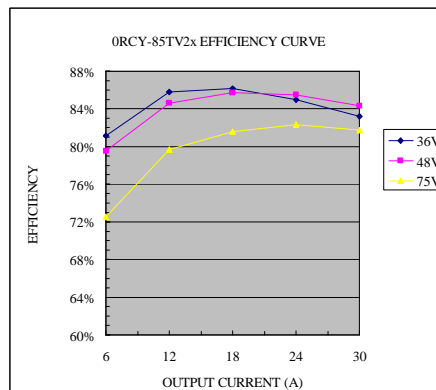
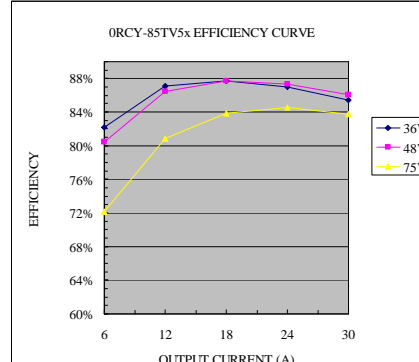
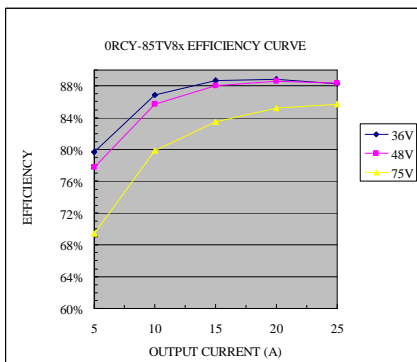
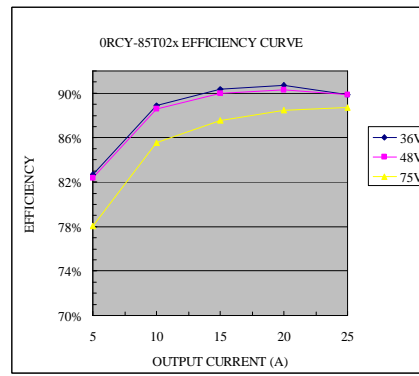
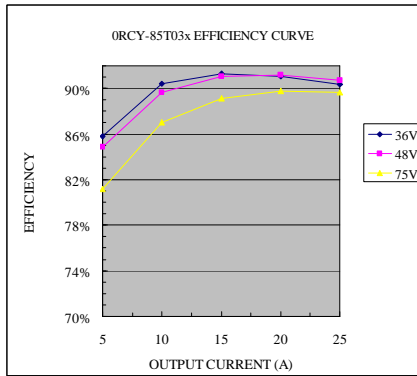
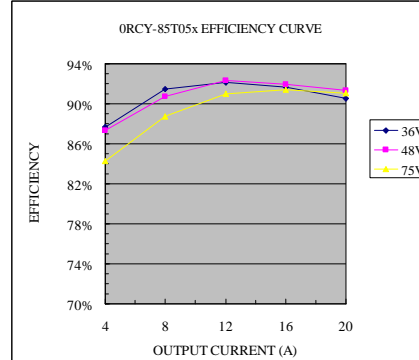
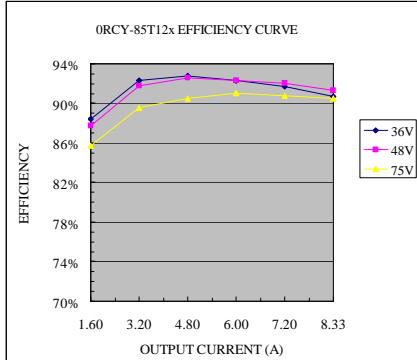

# ISOLATED DC/DC CONVERTERS

48 Vdc Input 1.2 Vdc - 12 Vdc / 8.33 A - 30 A Output, 1/8 Brick



## Thermal Derating Curves

Vin=48V, with maximum junction temperature of semiconductors derated to 120 degree C.

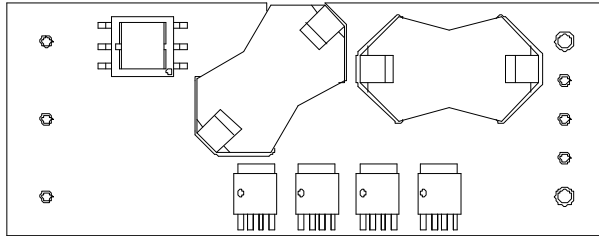

Forced Airflow Direction

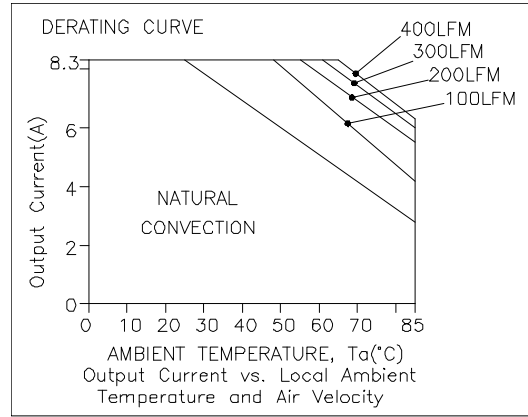

ORCY-85T12x

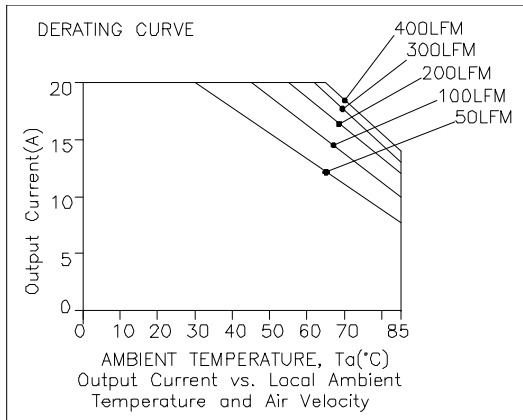

ORCY-85T05x

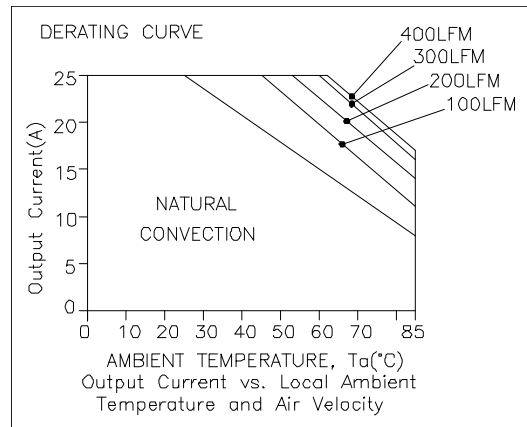

ORCY-85T03x

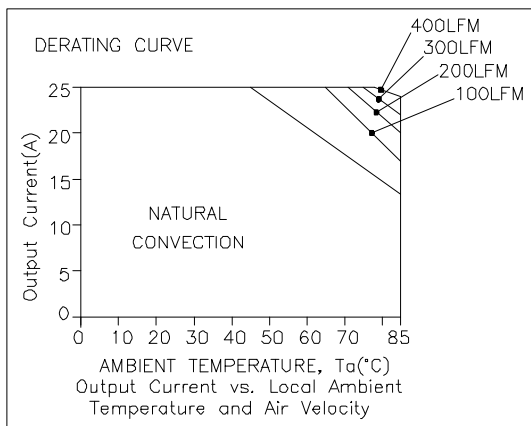

ORCY-85T02x

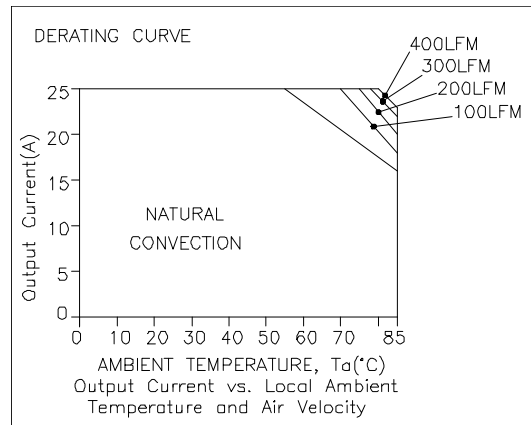

ORCY-85TV8x

# ISOLATED DC/DC CONVERTERS

48 Vdc Input 1.2 Vdc - 12 Vdc / 8.33 A - 30 A Output, 1/8 Brick



## Thermal Derating Curves (continued)

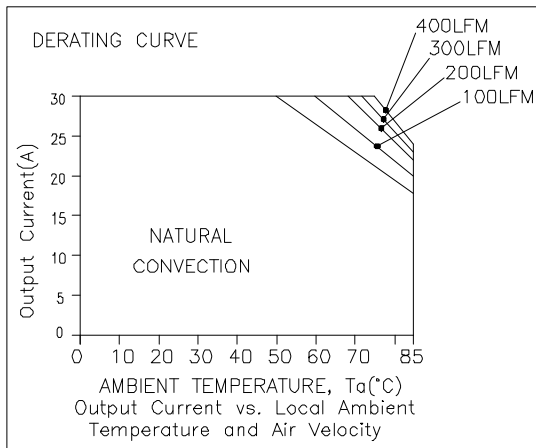

0RCY-85TV5x

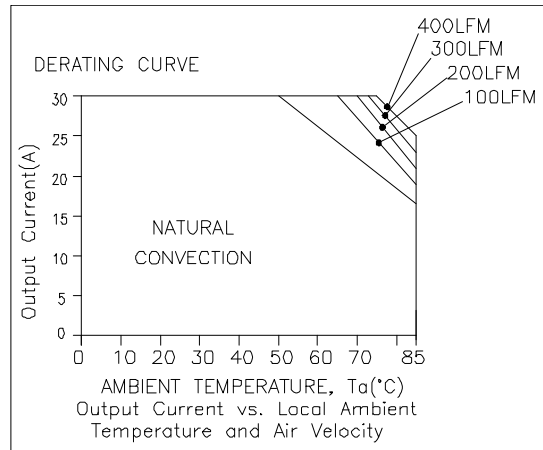

0RCY-85TV2x

## Thermal Reference

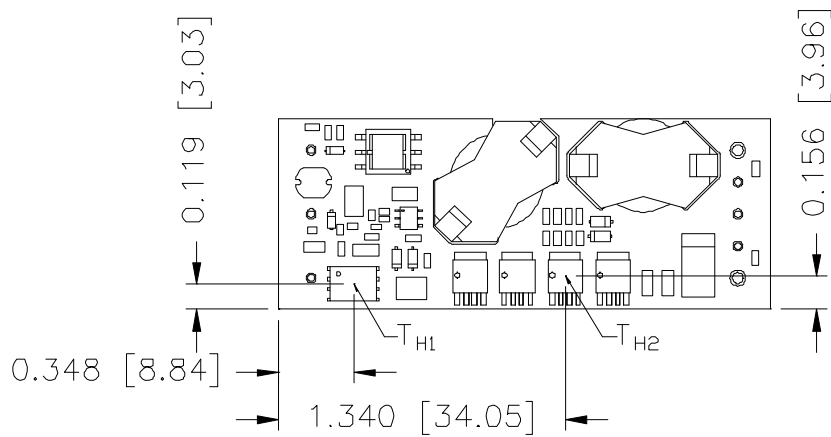

**Note:**  $T_{H1}$  and  $T_{H2}$  are hot spots which should not exceed 118 degree C.

# ISOLATED DC/DC CONVERTERS

48 Vdc Input 1.2 Vdc - 12 Vdc / 8.33 A - 30 A Output, 1/8 Brick



## Ripple and Noise Waveforms

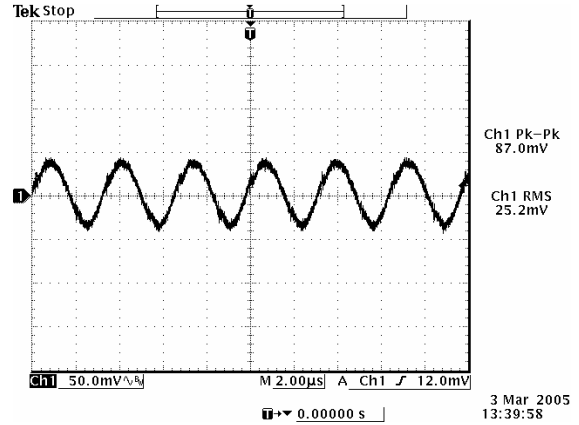
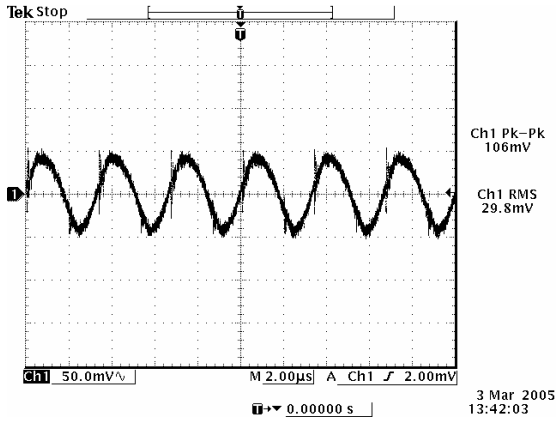

Ripple and noise at max load 12 Vdc/8.33 A output

Ripple and noise at max load 5.0 Vdc/20 A output

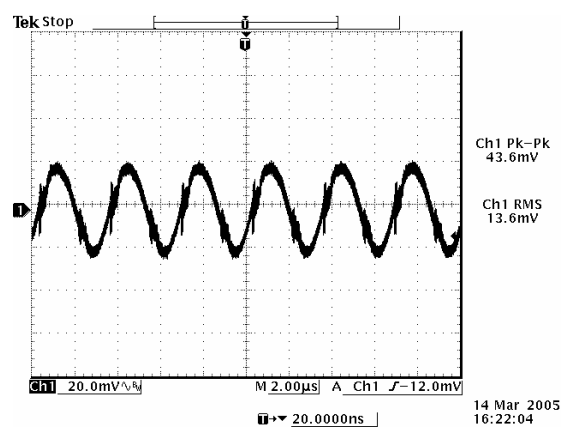
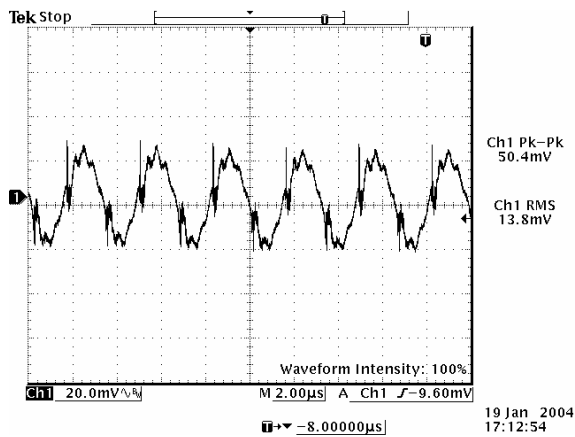

Ripple and noise at max load 3.3 Vdc/25 A output

Ripple and noise at max load 2.5 Vdc/25 A output

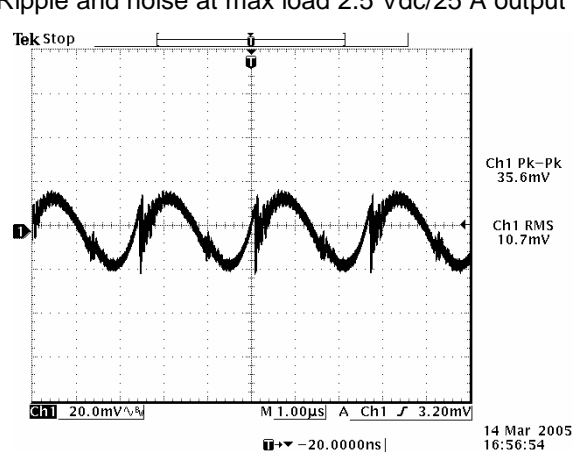
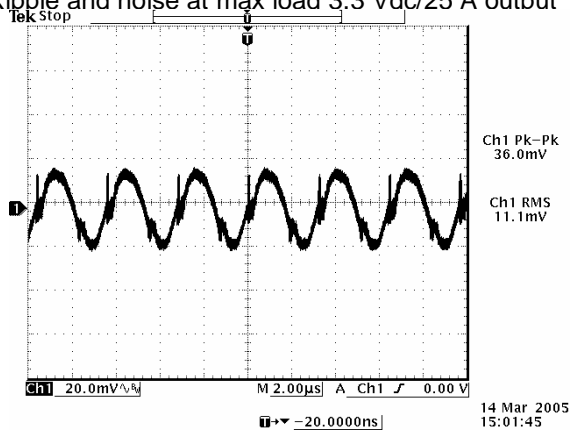

Ripple and noise at max load 1.8 Vdc/25 A output

Ripple and noise at max load 1.5 Vdc/30 A output

# ISOLATED DC/DC CONVERTERS

48 Vdc Input 1.2 Vdc - 12 Vdc / 8.33 A - 30 A Output, 1/8 Brick



## Ripple and Noise Waveforms (continued)

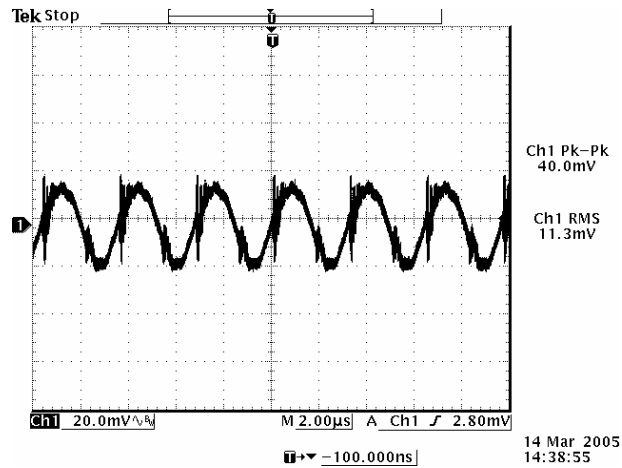

Ripple and noise at max load 1.2 Vdc/30 A output

**Note:** Ripple and Noise at 48 V input, with a 1 uF ceramic capacitor and a 10 uF tantalum capacitor at the output, and Ta=25 deg C

## Transient Response Waveforms

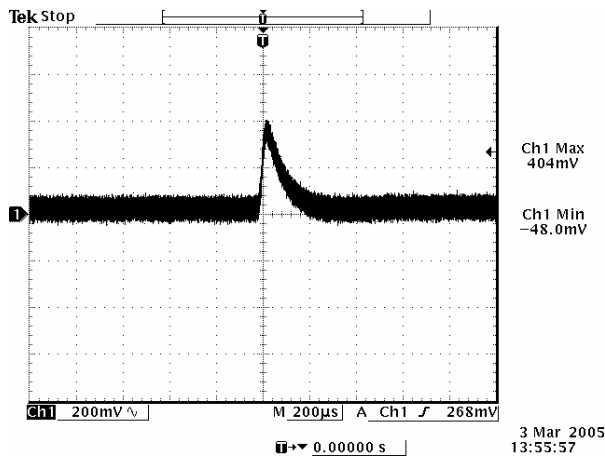

Transients 50% to 25% load 12 Vdc output

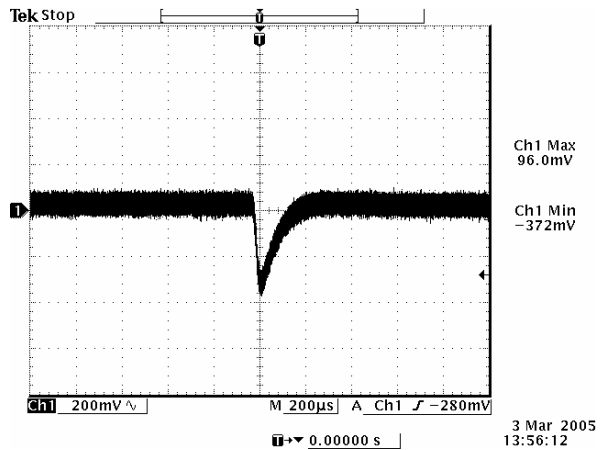

Transients 25% to 50% load 12 Vdc output

# ISOLATED DC/DC CONVERTERS

48 Vdc Input 1.2 Vdc - 12 Vdc / 8.33 A - 30 A Output, 1/8 Brick



## Transient Response Waveforms (continued)

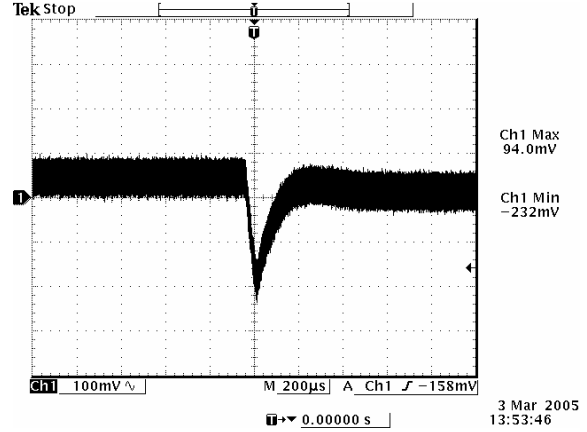
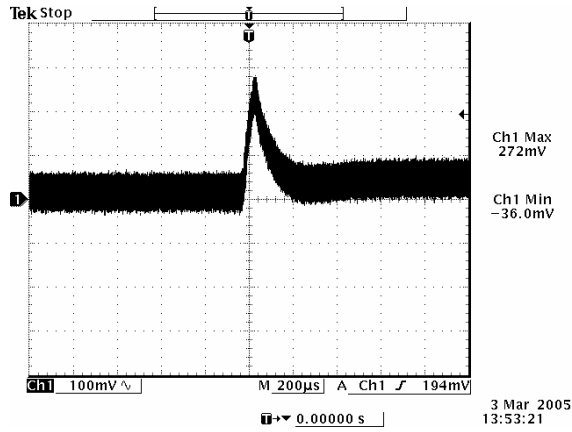

Transients 50% to 25% load 5.0 Vdc output

Transients 25% to 50% load 5.0 Vdc output

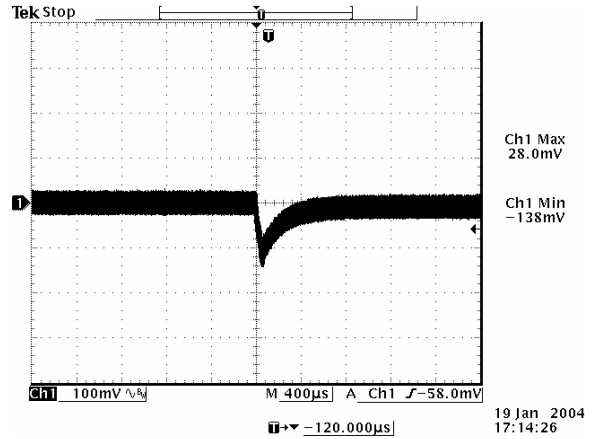
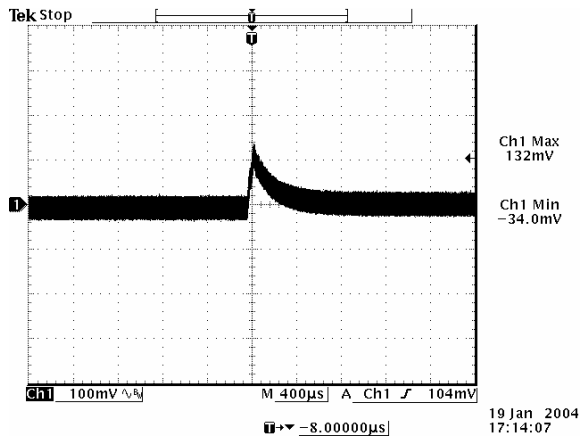

Transients 50% to 25% load 3.3 Vdc output

Transients 25% to 50% load 3.3 Vdc output

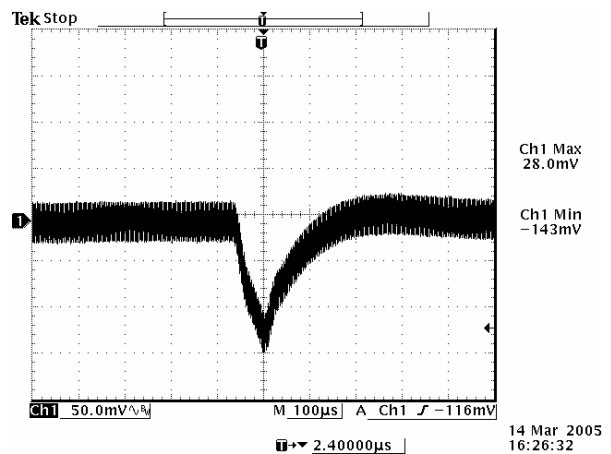
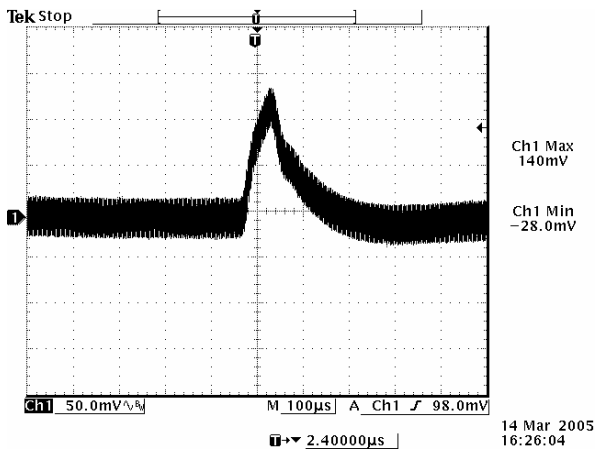

Transients 50% to 25% load 2.5 Vdc output

Transients 25% to 50% load 2.5 Vdc output

# ISOLATED DC/DC CONVERTERS

48 Vdc Input 1.2 Vdc - 12 Vdc / 8.33 A - 30 A Output, 1/8 Brick



## Transient Response Waveforms (continued)

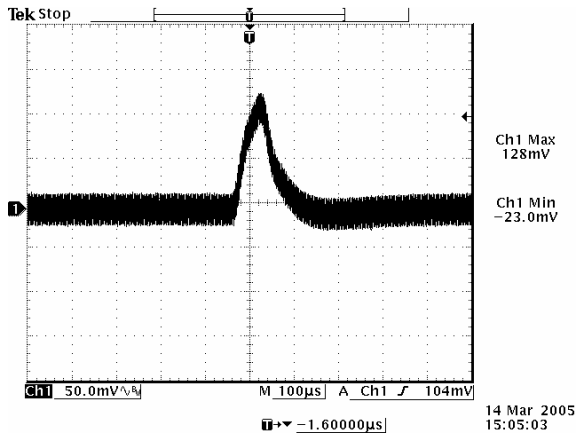

Transients 50% to 25% load 1.8 Vdc output

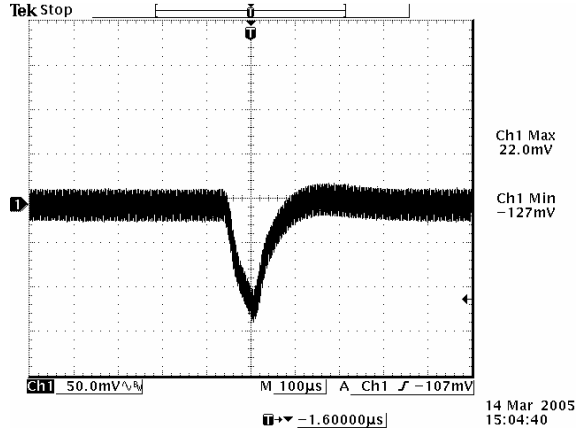

Transients 25% to 50% load 1.8 Vdc output

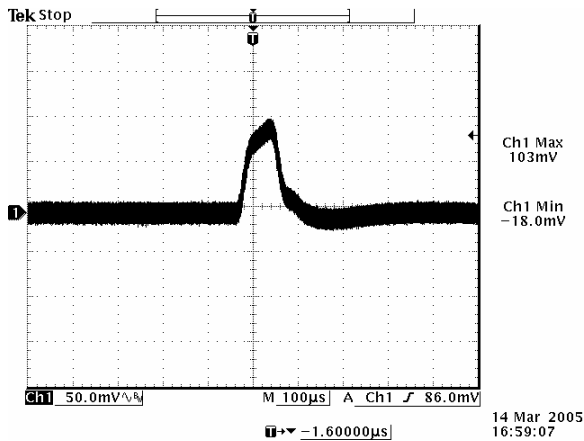

Transients 50% to 25% load 1.5 Vdc output

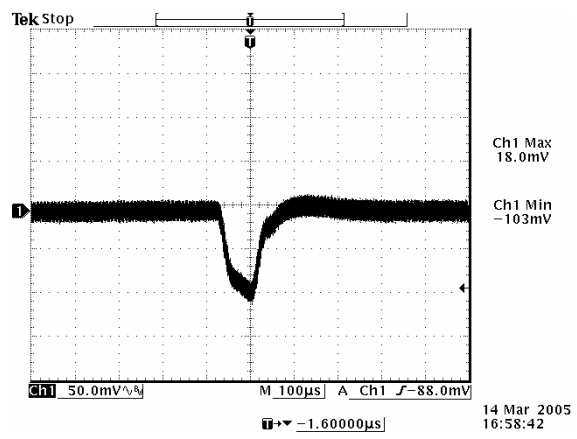

Transients 25% to 50% load 1.5 Vdc output

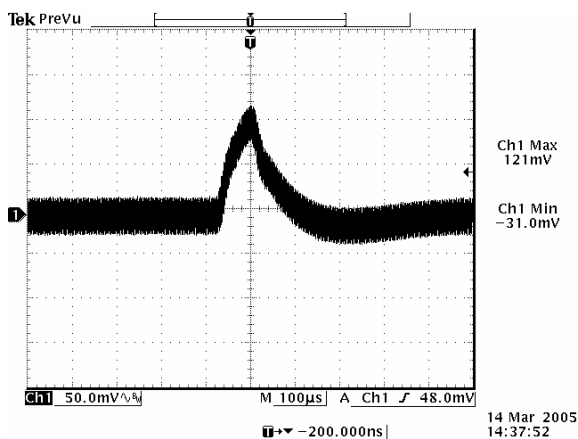

Transients 50% to 25% load 1.2 Vdc output

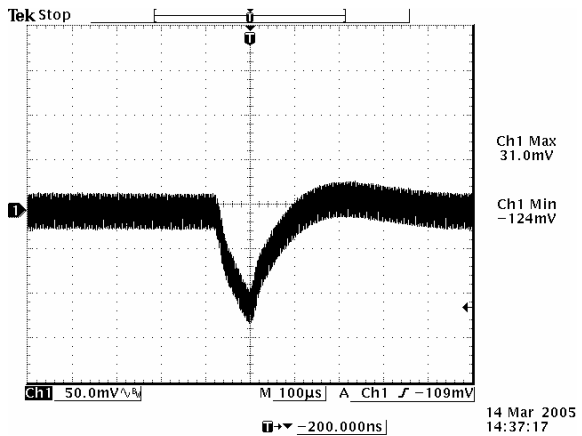

Transients 25% to 50% load 1.2 Vdc output

**Note:** Transient response at 48 V input,  $di/dt=0.1$  A/uS, with external 10 uF tantalum cap and 1 uF ceramic cap at the output,  $T_a=25$  deg C.

# ISOLATED DC/DC CONVERTERS

48 Vdc Input 1.2 Vdc - 12 Vdc / 8.33 A - 30 A Output, 1/8 Brick



## Mechanical Outline

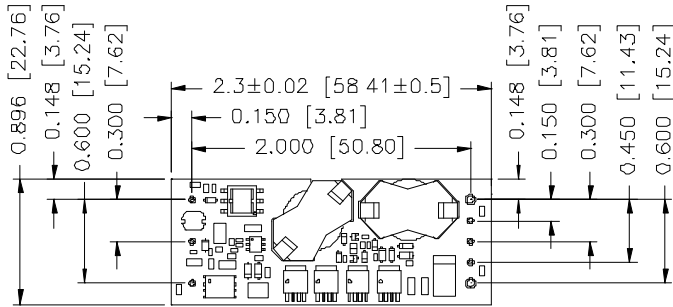

TOP VIEW

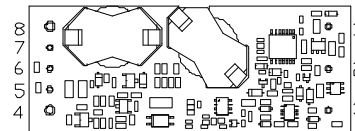

BOTTOM VIEW

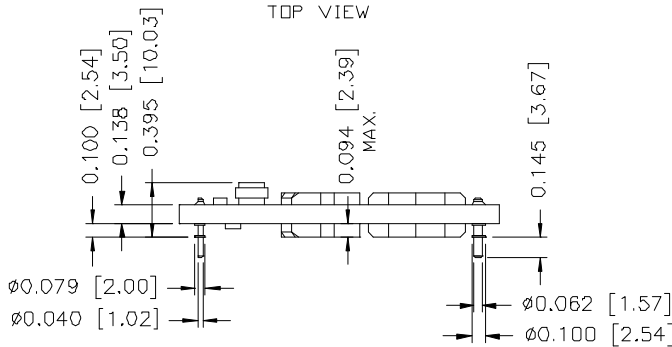

RECOMMENDED PAD LAYOUT

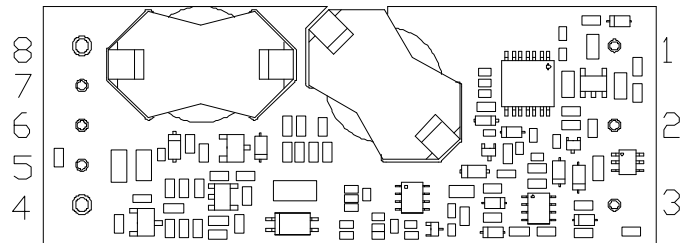

BOTTOM VIEW

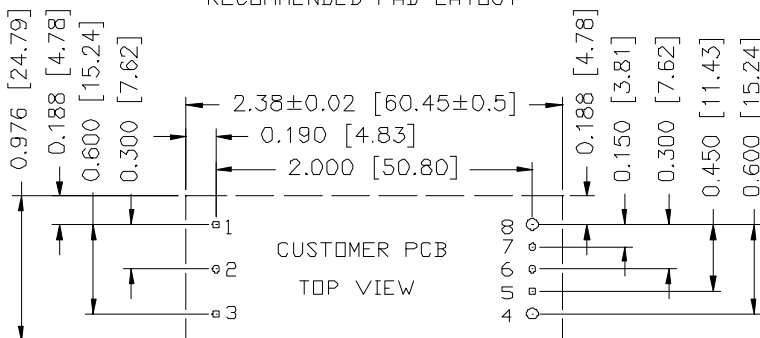

CUSTOMER PCB  
TOP VIEW

## Pin Connections

Pin	Function	Pin Dia
1	Vin+	0.040"
2	Remote On/Off	0.040"
3	Vin-	0.040"
4	Vout-	0.062"
5	Sense-	0.040"
6	Trim	0.040"
7	Sense+	0.040"
8	Vout+	0.062"

1,2,3,5,6,7 Ø0.047 HOLE SIZE, Ø0.08 min PAD SIZE  
4,8 Ø0.07 HOLE SIZE, Ø0.10 min PAD SIZE

## RoHS Compliance

Complies with the European Directive 2002/95/EC, calling for the elimination of lead and other hazardous substances from electronic products.



©2009 Bel Fuse Inc. Specifications subject to change without notice. 052609

### CORPORATE

**Bel Fuse Inc.**  
206 Van Vorst Street  
Jersey City, NJ 07302  
Tel 201-432-0463  
Fax 201-432-9542  
[www.belfuse.com](http://www.belfuse.com)

### FAR EAST

**Bel Fuse Ltd.**  
8F/ 8 Luk Hop Street  
San Po Kong  
Kowloon, Hong Kong  
Tel 852-2328-5515  
Fax 852-2352-3706  
[www.belfuse.com](http://www.belfuse.com)

### EUROPE

**Bel Fuse Europe Ltd.**  
Preston Technology Management Centre  
Marsh Lane, Suite G7, Preston  
Lancashire, PR1 8UD, U.K.  
Tel 44-1772-556601  
Fax 44-1772-888366  
[www.belfuse.com](http://www.belfuse.com)