

ISOLATED DC/DC CONVERTERS

48 Vdc Input 1.8 Vdc /25 A Output, 1/8 Brick Converter

bel
POWER PRODUCTS

0RCB-60TV8x Rev.B RoHS Compliant File Rev.A

- Isolated
- High Efficiency
- High Power Density
- Fixed Frequency (300 kHz)
- Low Cost
- Input Under-Voltage Lockout
- EN60950-1 Recognized
- Pre-Bias Start Up
- Output Over-Voltage Shutdown
- OCP/SCP
- Over Temperature Protection
- Remote On/Off
- Output Voltage Trim
- Positive/Negative Remote Sense
- Basic Insulation

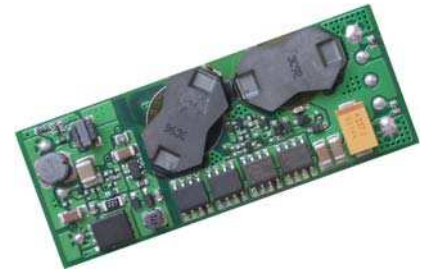

Description

The 0RCB-60TV8x is isolated dc/dc converter that operates from a nominal 48 Vdc source. This unit will provide up to 45 W of output power from a nominal 48 Vdc input. This unit is designed to be highly efficient and low cost. Features include remote on/off, over current protection and under-voltage lockout. This converter is provided in an industry standard eighth brick package.

Part Selection

Output Voltage	Input Voltage	Max. Output Current	Max. Output Power	Typical Efficiency	Model Number Active High	Model Number Active Low
1.8 Vdc	36 Vdc - 75 Vdc	25 A	45 W	89%	0RCB-60TV80	0RCB-60TV8L

- Notes:**
1. Change the last character to "A" to indicate 100 Ω sense resistors internally and active low.
 2. Add "G" suffix at the end of the model number to indicate Tray Packaging.
 3. All part numbers above indicate RoHS 6. Change the second letter "R" to "7" for RoHS 5 part numbers.

Absolute Maximum Ratings

Parameter	Min	Typ	Max	Notes
Input Voltage (continuous)	-0.3 V	-	80 V	
Remote On/Off	-0.3 V	-	18 V	
I/O Isolation Voltage	-	-	1500 V	
Input to Each Output Resistance	10M ohm	-	-	
Ambient Temperature	-40 °C	-	85 °C	
Storage Temperature	-55 °C	-	125 °C	

Input Specifications

Parameter	Min	Typ	Max	Notes
Input Voltage	36 V	48 V	75 V	
Input Current (full load)	-	-	1.8 A	
Input Current (no load)	-	-	55 mA	
Input Reflected Ripple Current (pk-pk)	-	-	15 mA	Tested with simulated source impedance of 10 μ H, 5 Hz to 20 MHz; use a 47 μ F/100 V electrolytic capacitor with ESR = 1 ohm max. at 200 kHz at 25 °C.
Input Fuse (not internally)	-	-	5.0 A	
I ² t Inrush Current Transient	-	-	0.1 A ² s	
Turn-on Voltage Threshold	33 V	-	35 V	
Turn-off Voltage Threshold	31 V	-	33 V	

ISOLATED DC/DC CONVERTERS

48 Vdc Input 1.8 Vdc /25 A Output, 1/8 Brick Converter



Output Specifications

Parameter	Min	Typ	Max	Notes	
Output Voltage Range	1.746 V	1.8 V	1.854 V	Over all line, load & temperature conditions.	
Output Voltage Trim Range	1.44 V	-	1.98 V		
Output Over-Voltage Clamp Non-Latching	2.1 V	-	2.34 V		
Output Current	-	-	25 A		
Current Limit Threshold	27.5 A	-	34 A		
External Admissible Capacitive Load	0 uF	-	20000 uF		
Ripple and Noise (pk-pk)	-	-	130 mV	Vin=72 V, max load on output, 20 MHz BW, 10uF tantalum and 1uF ceramic capacitor.	
Turn on Time	-	-	240 mS		
Rise Time	-	-	18 mS		
Transient Response					
50% ~ 75% ~ 50% Max Load	Vpk-pk	-	-	220 mV	di/dt=0.1A/us, Vin=48Vdc, Ta=25°C, with a 1uF ceramic capacitor and a 10uF Tantalum cap at the output.
	Settling Time	-	-	300 uS	

Note: All specifications are typical at 25 °C unless otherwise stated.

General Specifications

Parameter	Min	Typ	Max	Notes
Efficiency	84%	89%	-	Measured with full load at all conditions.
Switching Frequency	270 kHz	300 kHz	330 kHz	
Isolation capacitance	-	3900 pF	-	
Remote Sense Compensation	-	-	10%	The total voltage increased by trim and remote sense should not exceed 10%Vo.
Over Temperature Protection	-	125 °C	-	
MTBF	2,370,000 hours			Calculated Per Bell Core SR-332 (Vin=48 V, Vo=1.8 V, Io=20 A, Ta = 25 °C)
Dimensions Inches (L x W x H) Millimeters (L x W x H)	2.30 x 0.896 x 0.374 58.42 x 22.76 x 9.50			
Weight	-	26 g	-	

Note: All specifications are typical at 25 °C unless otherwise stated.

Control Specifications

Parameter	Min	Typ	Max	Notes
Remote On/Off				
Signal Low (Unit On)	Active Low	-0.3 V	-	0RCB-60TV8L. The remote on/off pin open, Unit off.
Signal High (Unit Off)		2.4 V	-	
Signal Low (Unit Off)	Active High	-0.3 V	-	0RCB-60TV80. The remote on/off pin open, Unit on.
Signal High (Unit On)		2.4 V	-	
Current Sink	0 mA	-	1 mA	

ISOLATED DC/DC CONVERTERS

48 Vdc Input 1.8 Vdc /25 A Output, 1/8 Brick Converter

bel
POWER PRODUCTS

Output Trim Equations

Equations for calculating the trim resistor are shown below. The Trim Down resistor should be connected between the Trim pin and Sense (-) pin. The Trim Up resistor should be connected between the Trim pin and the Sense (+). Only one of the resistors should be used for any given application.

$$R_{trimdown} = \frac{511}{|\delta|} - 10.22 [k\Omega]$$

$$R_{trimup} = \left(\frac{(100 + \delta) \cdot V_o \cdot 5.11}{1.225 \cdot \delta} - \frac{511}{\delta} - 10.22 \right) [k\Omega]$$

Note:

$$\delta = \frac{(V_o_{req} - V_o)}{V_o} \times 100 [\%]$$

V_o_{req} = Desired (trimmed) output voltage [V]
Output voltage V_o = 1.804 V

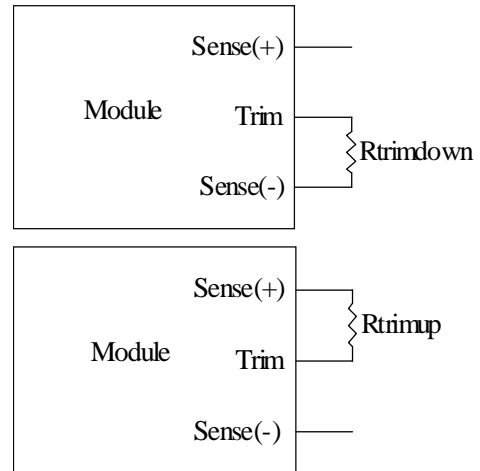

Efficiency Data

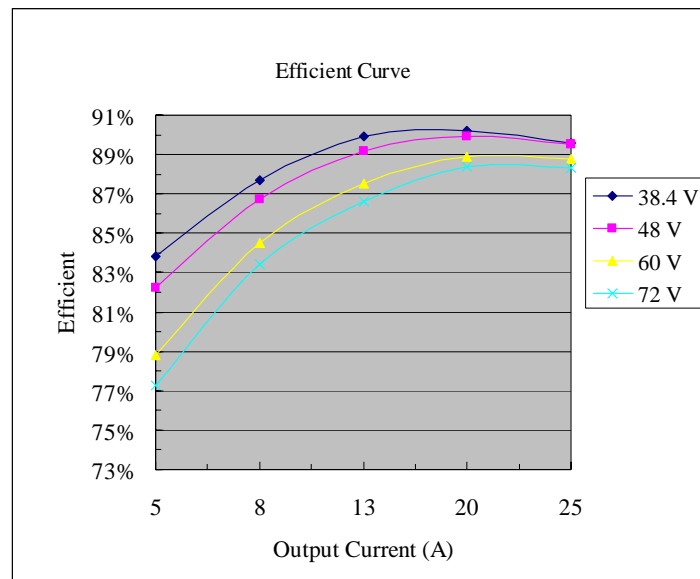

ORCB-60TV8x

ISOLATED DC/DC CONVERTERS

48 Vdc Input 1.8 Vdc /25 A Output, 1/8 Brick Converter

bel
POWER PRODUCTS

Thermal Derating Curves

Vin=48V, with maximum junction temperature of semiconductors derated to 120 degree C.

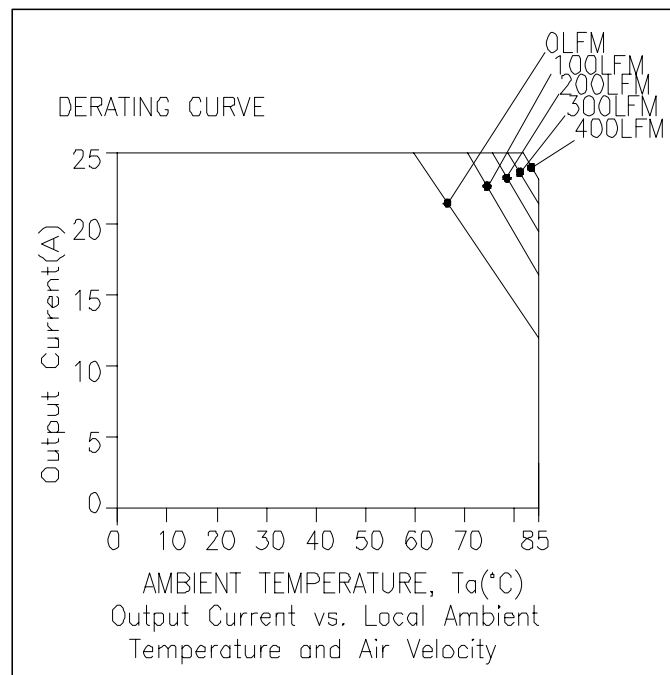
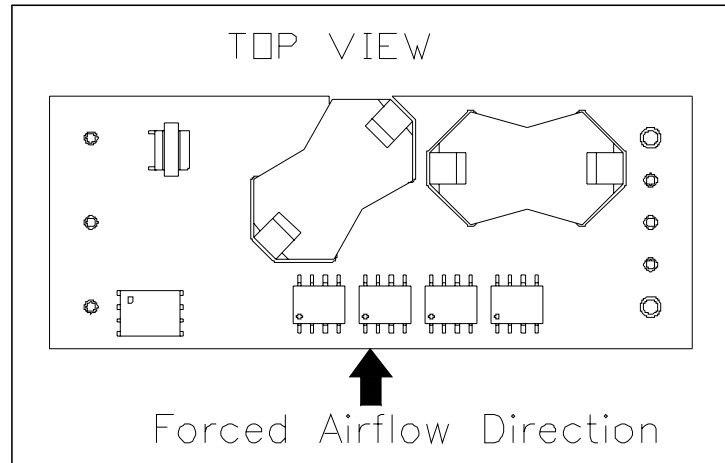

0RCB-60TV8x

ISOLATED DC/DC CONVERTERS

48 Vdc Input 1.8 Vdc /25 A Output, 1/8 Brick Converter



Thermal Derating Curves (continued)

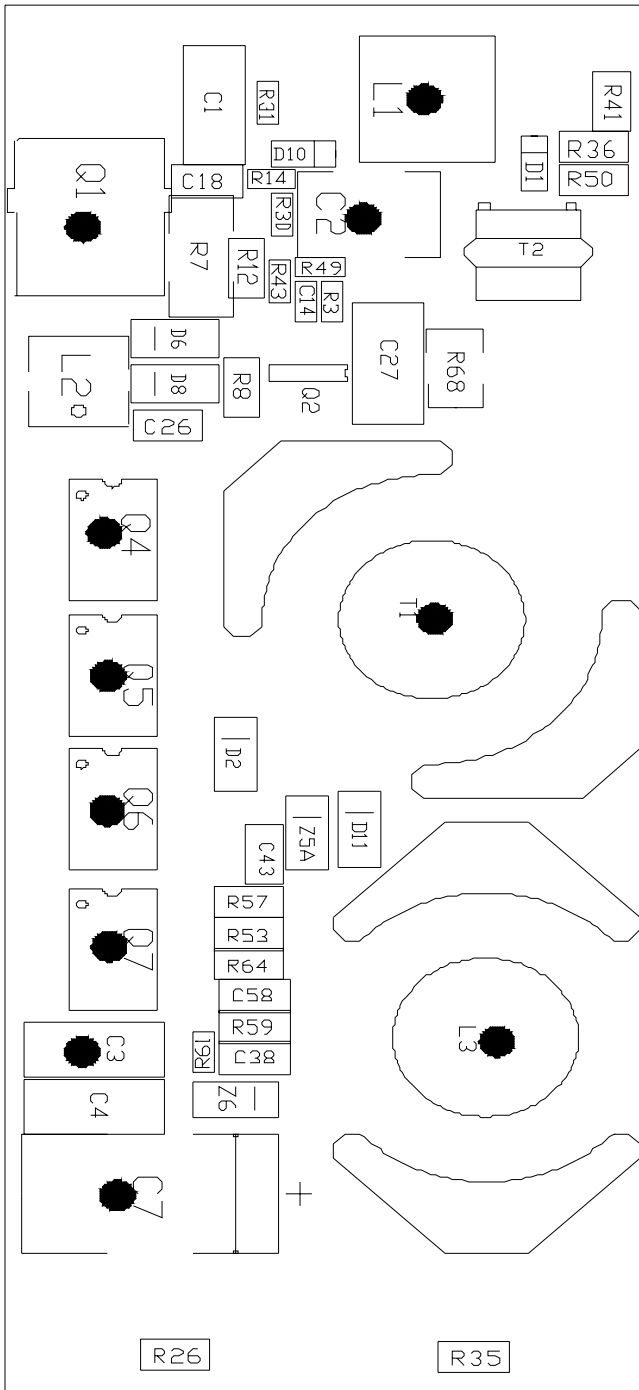

Temperature reference points on top side

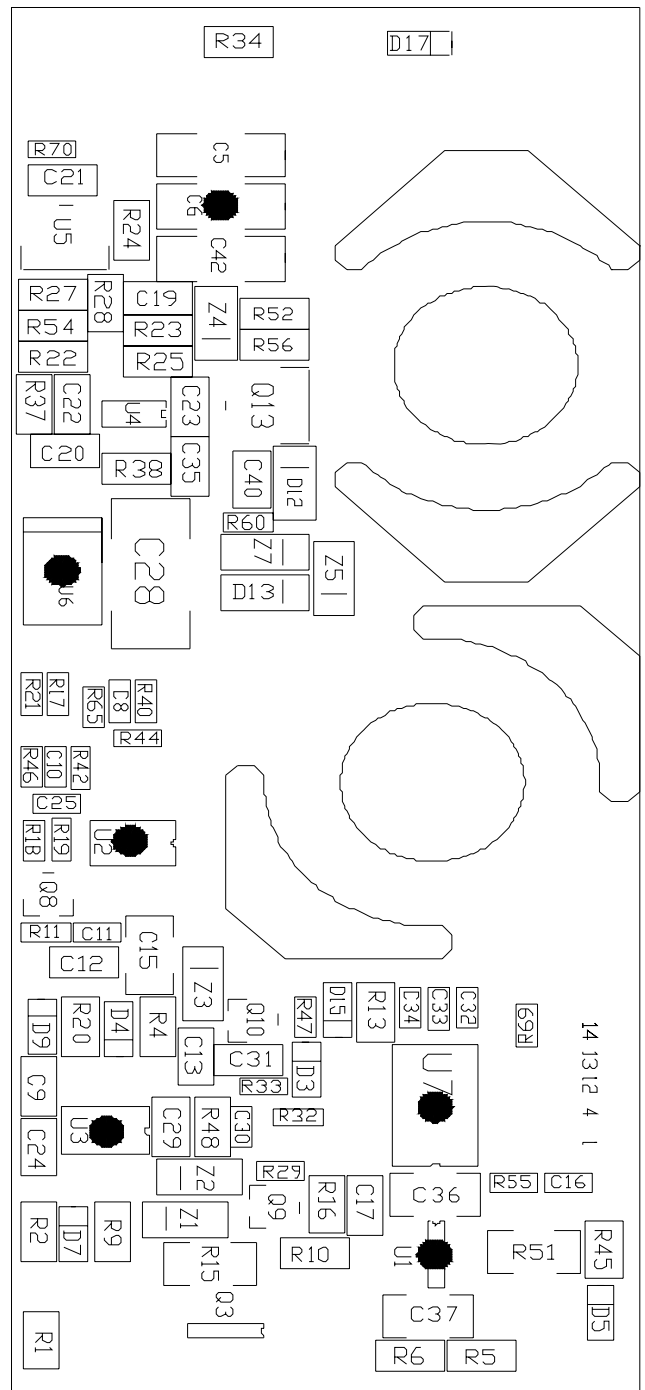

Temperature reference points on bottom side

ISOLATED DC/DC CONVERTERS

48 Vdc Input 1.8 Vdc /25 A Output, 1/8 Brick Converter



Safety

Material flammability: UL94V-0

Electromagnetic Compatibility EMC

1. Electric field IEC801-3(1984), IEC1000-4-3
2. Fast transient/burst IEC801-4(1988), IEC1000-4-4

Input RFI level conducted and radiated (subject to test by customer)

Compliance to EN55022 class A (both q.peak and average) with the following inductive and capacitive filter

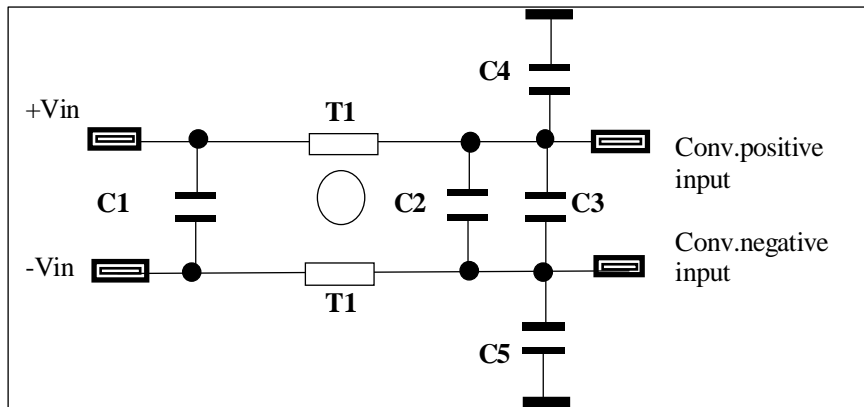

C1=3.3 uF /100 V;
C2=C3= 47 uF/100 V;
C4=C5=1000 pF/250 Volt;
T1=3 mH.

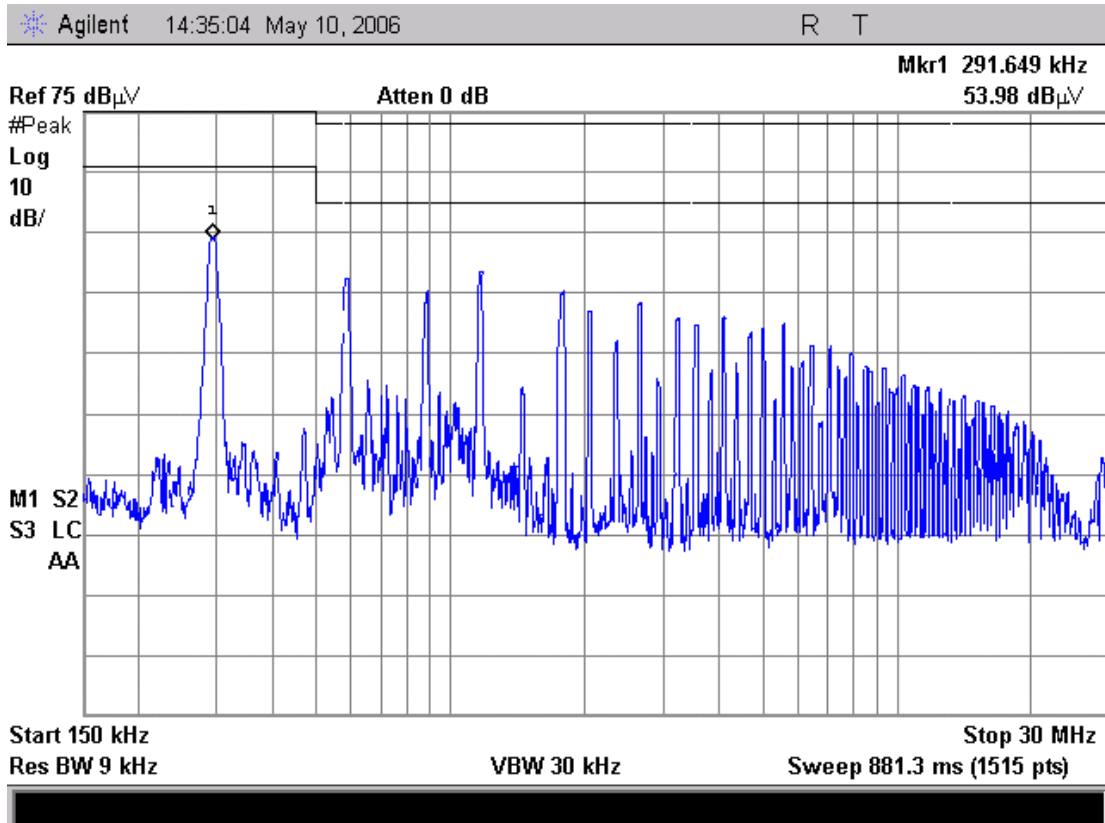

ISOLATED DC/DC CONVERTERS

48 Vdc Input 1.8 Vdc /25 A Output, 1/8 Brick Converter



Transient Response Waveform

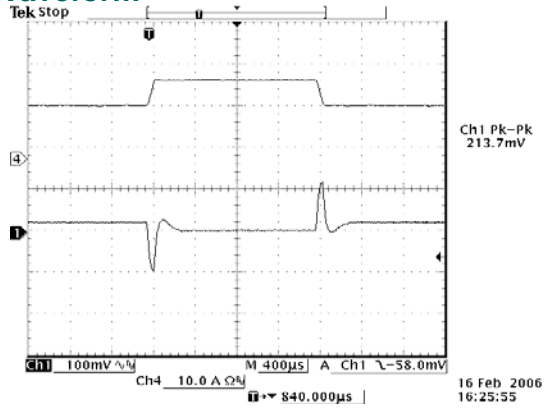

Note: Dynamic load transient at $V_{in} = 48\text{ V}$, $T_a = 25\text{ }^\circ\text{C}$, $I_o = (50\% \sim 75\% \sim 50\%) I_{onom}$, $di/dt = 0.1\text{ A/uS}$.

Ripple and Noise Waveforms

$C_1 = 10\text{ }\mu\text{F}$ tantalum, $C_2 = 1\text{ }\mu\text{F}$ ceramic;
 $R = 50\text{ ohm}$;
 $C = 220\text{ nF}$.

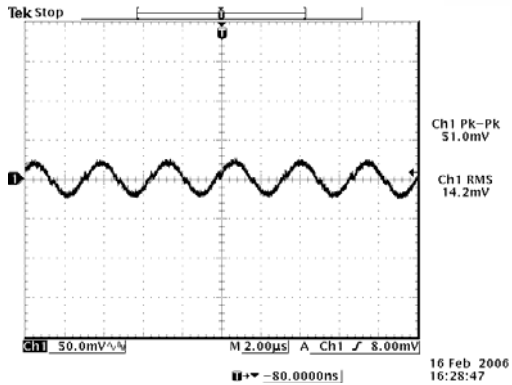
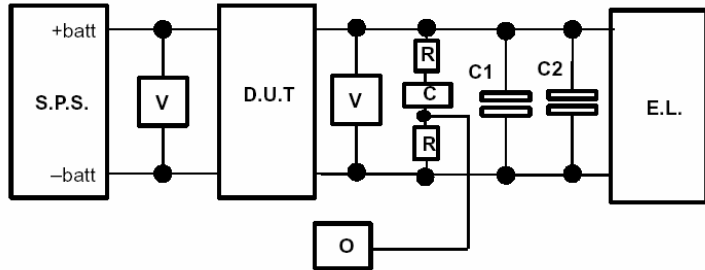

$V_{in} = 38.4\text{ V}$ and $I_{out} = 25\text{ A}$

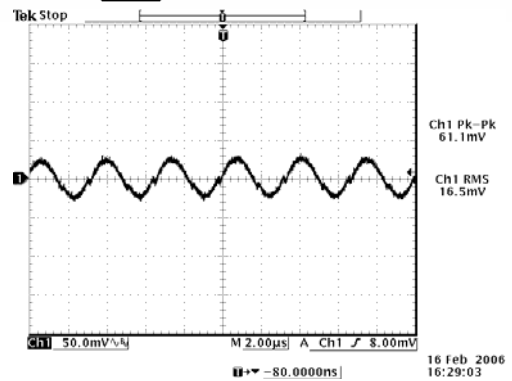

$V_{in} = 48\text{ V}$ and $I_{out} = 25\text{ A}$

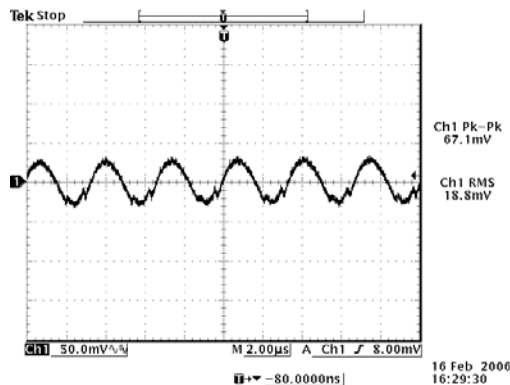

$V_{in} = 72\text{ V}$ and $I_{out} = 25\text{ A}$

ISOLATED DC/DC CONVERTERS

48 Vdc Input 1.8 Vdc /25 A Output, 1/8 Brick Converter



Mechanical Outline

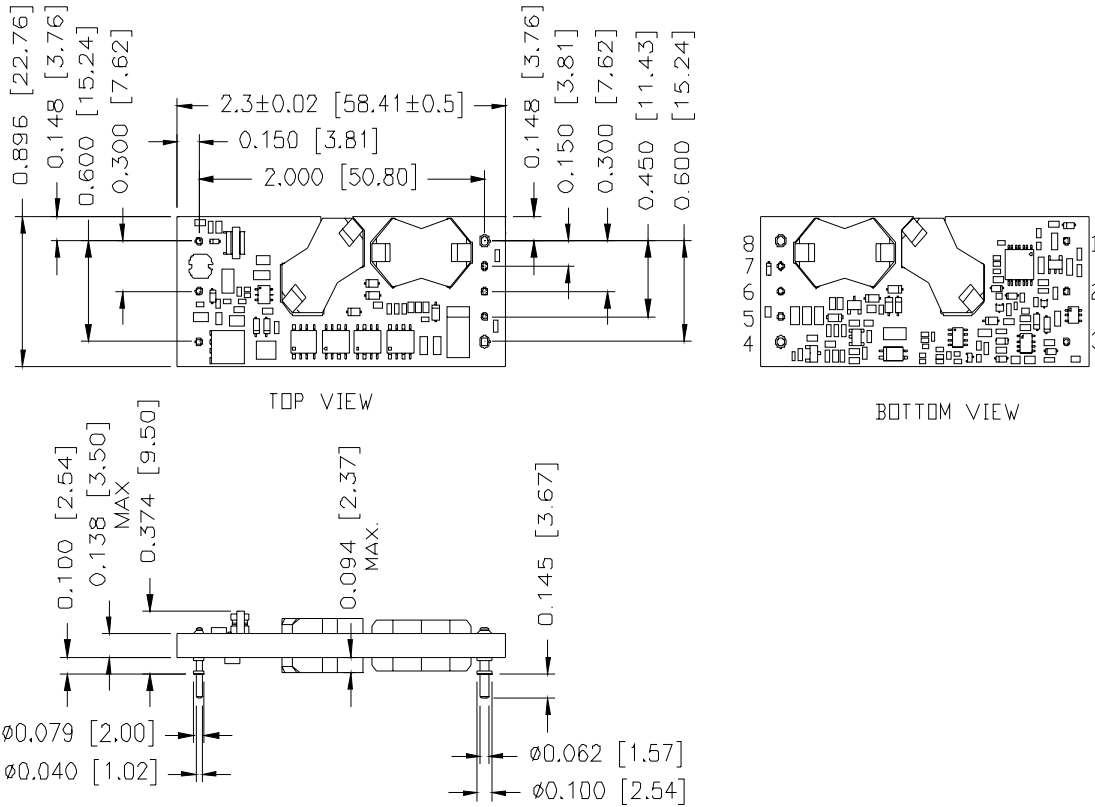

Note: The module doesn't guarantee at least 0.7mm as clearance distance on bottom side. This issue should be considered if any copper traces are on the top side of the user's board.

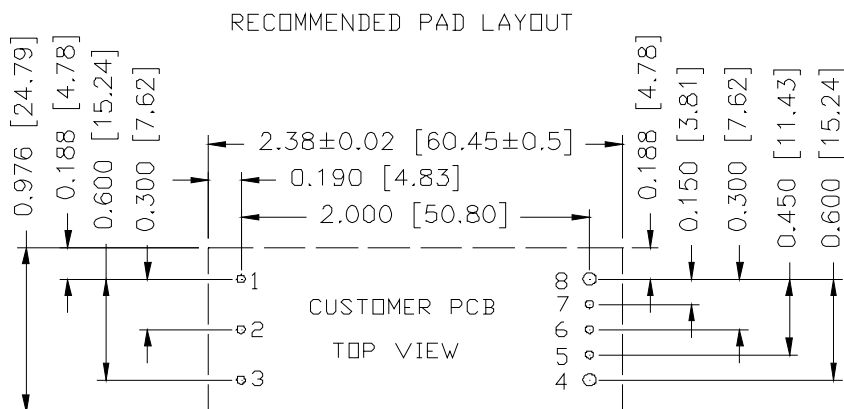

1,2,3,5,6,7 \varnothing 0.047 HOLE SIZE, \varnothing 0.08 min PAD SIZE
 4,8 \varnothing 0.07 HOLE SIZE, \varnothing 0.10 min PAD SIZE

ISOLATED DC/DC CONVERTERS

48 Vdc Input 1.8 Vdc /25 A Output, 1/8 Brick Converter



Pin Connections

Pin	Name	Function	Pin Dia
1	Vin+	Positive input voltage	0.040"
2	On/Off	Input to turn converter on and off, referenced to Vin-	0.040"
3	Vin-	Negative input voltage	0.040"
4	Vout-	Negative output voltage	0.062"
5	Sense-	Negative remote sense	0.040"
6	Trim	Output voltage trim	0.040"
7	Sense+	Positive output voltage	0.040"
8	Vout+	Positive output voltage	0.062"

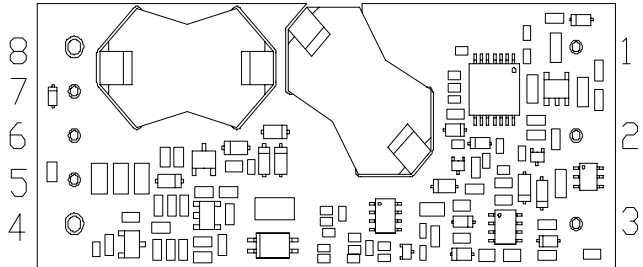

BOTTOM VIEW

- Notes:**
1. Pin 5 must be connected to Vout-.
 2. Leave Pin 6 open for nominal voltage.
 3. Pin 7 must be connected to Vout+.

Fundamental Circuit Diagram

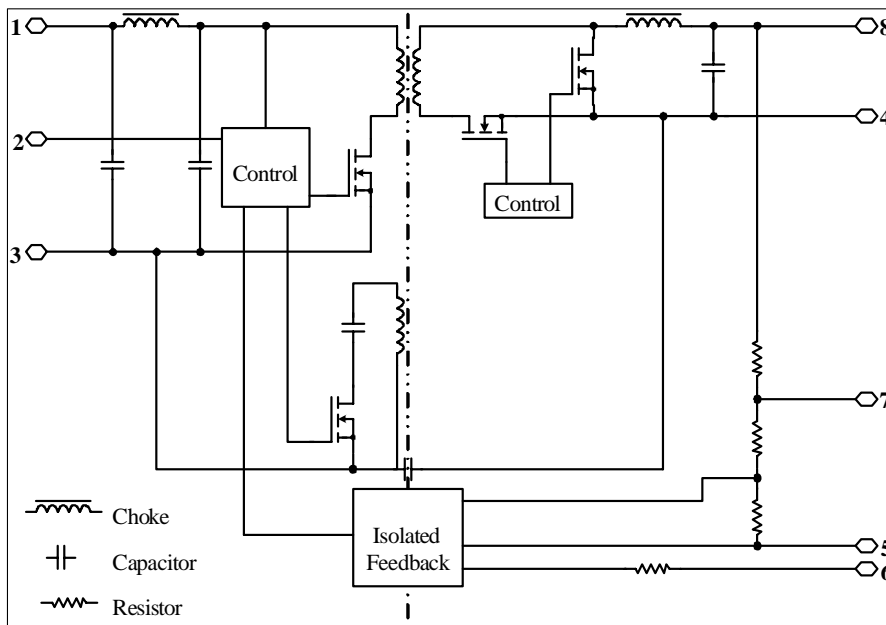

RoHS Compliance

Complies with the European Directive 2002/95/EC, calling for the elimination of lead and other hazardous substances from electronic products.



©2010 Bel Fuse Inc. Specifications subject to change without notice. 041910

CORPORATE

Bel Fuse Inc.
206 Van Vorst Street
Jersey City, NJ 07302
Tel 201-432-0463
Fax 201-432-9542
www.belfuse.com

FAR EAST

Bel Fuse Ltd.
8F/ 8 Luk Hop Street
San Po Kong
Kowloon, Hong Kong
Tel 852-2328-5515
Fax 852-2352-3706
www.belfuse.com

EUROPE

Bel Fuse Europe Ltd.
Preston Technology Management Centre
Marsh Lane, Suite G7, Preston
Lancashire, PR1 8UD, U.K.
Tel 44-1772-556601
Fax 44-1772-888366
www.belfuse.com