

Parameter	Tr1 and Tr2
V_{CEO}	50V
$I_{C(MAX.)}$	100mA
R_1	4.7k Ω

●Features

- 1) Built-In Biasing Resistors.
- 2) Two DTC143T chips in one package.
- 3) Built-in bias resistors enable the configuration of an inverter circuit without connecting external input resistors (see inner circuit).
- 4) The bias resistors consist of thin-film resistors with complete isolation to allow negative biasing of the input. They also have the advantage of completely eliminating parasitic effects.
- 5) Only the on/off conditions need to be set for operation, making the circuit design easy.
- 6) Lead Free/RoHS Compliant.

●Application

Inverter circuit, Interface circuit, Driver circuit

●Outline

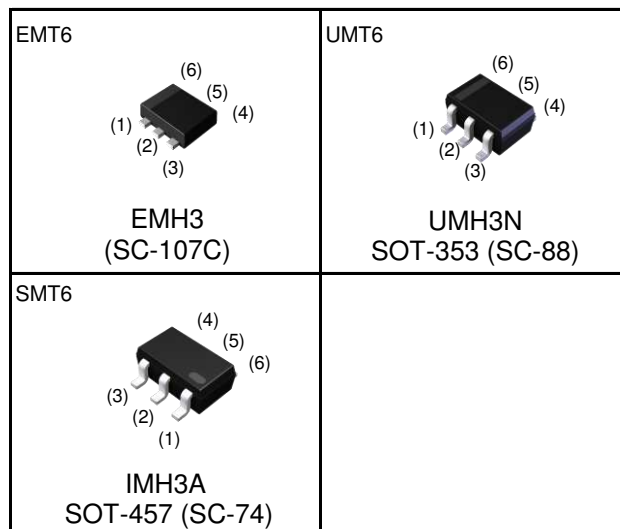

●Inner circuit

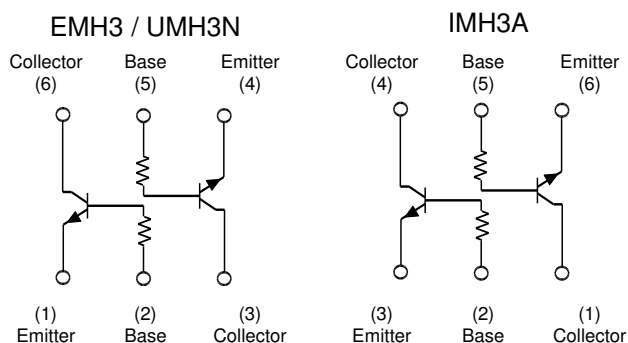

●Packaging specifications

Part No.	Package	Package size (mm)	Taping code	Reel size (mm)	Tape width (mm)	Basic ordering unit (pcs)	Marking
EMH3	EMT6	1616	T2R	180	8	8,000	H3
UMH3N	UMT6	2021	TR	180	8	3,000	H3
IMH3A	SMT6	2928	T108	180	8	3,000	H3

● **Absolute maximum ratings** (Ta = 25°C)

<For Tr1 and Tr2 in common>

Parameter		Symbol	Values	Unit
Collector-base voltage		V_{CBO}	50	V
Collector-emitter voltage		V_{CEO}	50	V
Emitter-base voltage		V_{EBO}	5	V
Collector current		$I_{C(MAX.)}^{*1}$	100	mA
Collector Power dissipation	EMH3 / UMH3N	P_D^{*2}	150 (Total) ^{*3}	mW
	IMH3A		300 (Total) ^{*4}	mW
Junction temperature		T_j	150	°C
Range of storage temperature		T_{stg}	-55 to +150	°C

● **Electrical characteristics** (Ta = 25°C)

<For Tr1 and Tr2 in common>

Parameter	Symbol	Conditions	Min.	Typ.	Max.	Unit
Collector-base breakdown voltage	BV_{CBO}	$I_C = 50\mu A$	50	-	-	V
Collector-emitter breakdown voltage	BV_{CEO}	$I_C = 1mA$	50	-	-	V
Emitter-base breakdown voltage	BV_{EBO}	$I_E = 50\mu A$	5	-	-	V
Collector cut-off current	I_{CBO}	$V_{CB} = 50V$	-	-	0.5	μA
Emitter cut-off current	I_{EBO}	$V_{EB} = 4V$	-	-	0.5	μA
Collector-emitter saturation voltage	$V_{CE(sat)}$	$I_C / I_B = 5mA / 0.25mA$	-	-	0.15	V
DC current gain	h_{FE}	$V_{CE} = 5V, I_C = 1mA,$	100	250	600	-
Input resistance	R_1	-	3.5	4.7	5.9	k Ω
Transition frequency	f_T^{*1}	$V_{CE} = 10V, I_E = -5mA,$ $f = 100MHz$	-	250	-	MHz

*1 Characteristics of built-in transistor

*2 Each terminal mounted on a reference footprint

*3 120mW per element must not be exceeded.

*4 200mW per element must not be exceeded.

●Electrical characteristic curves(Ta = 25°C)

Fig.1 Grounded emitter propagation characteristics

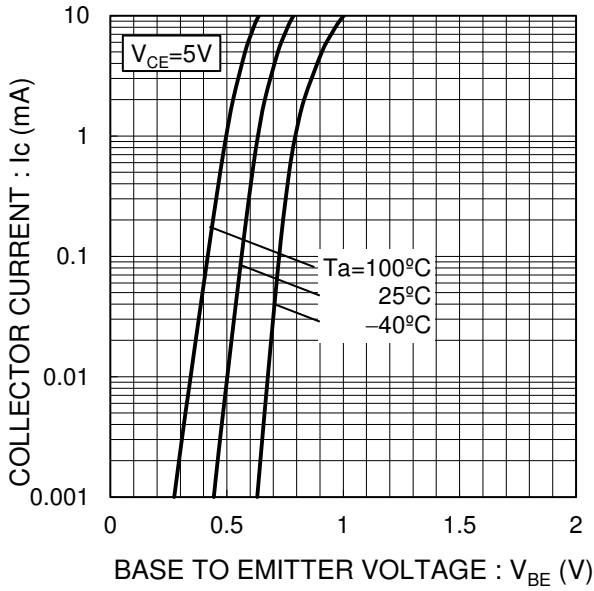

Fig.2 Grounded emitter output characteristics

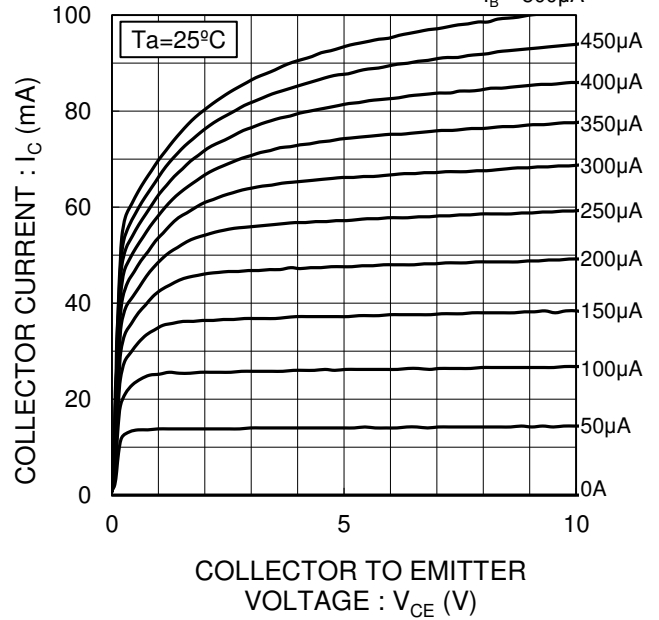

Fig.3 DC Current gain vs. Collector Current

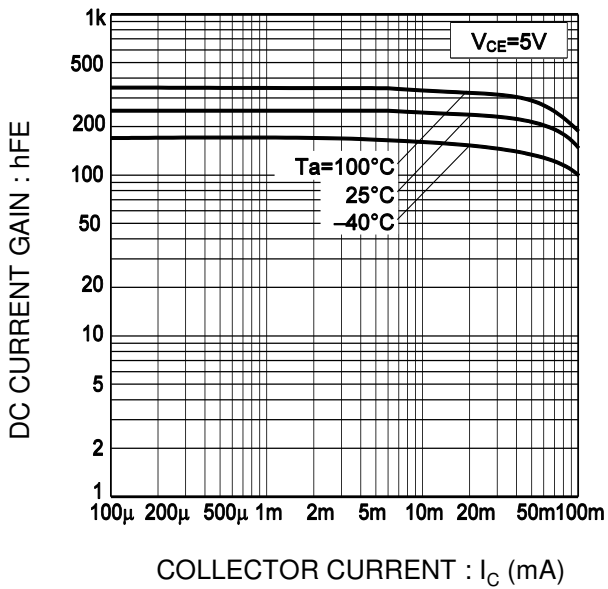
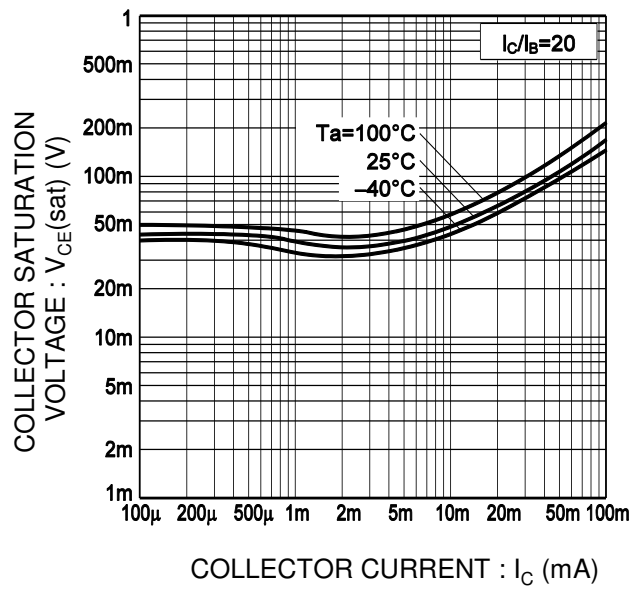
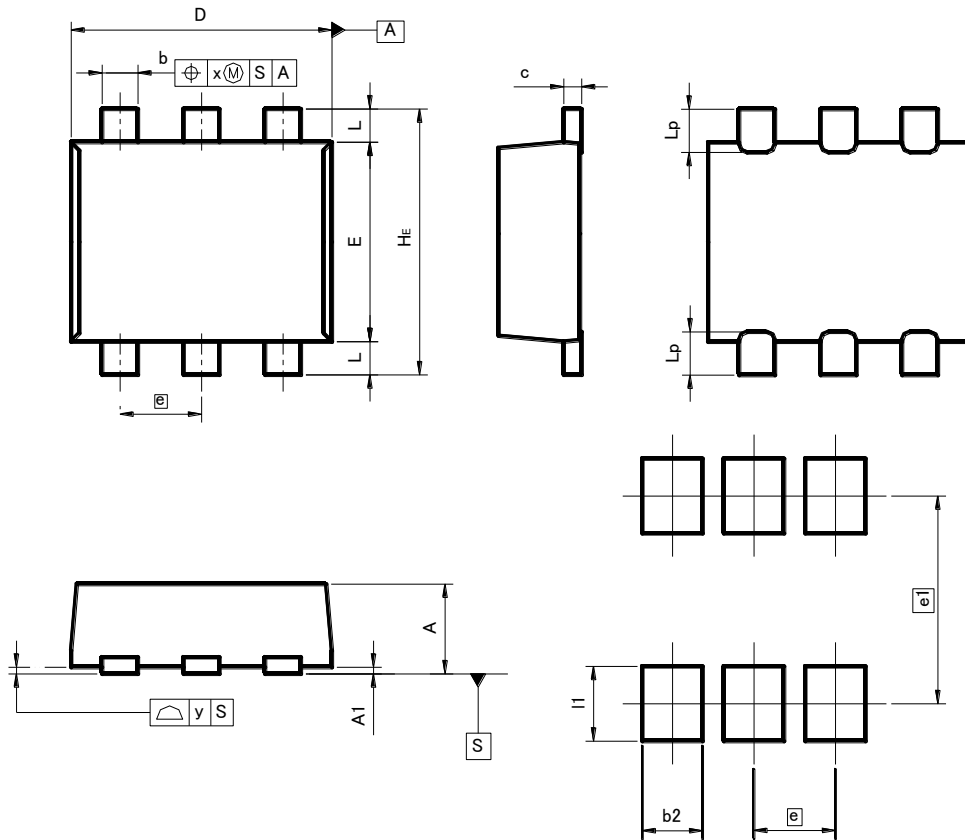

Fig.4 Collector-emitter saturation voltage vs. Collector Current



●Dimensions (Unit : mm)

EMT6



Pattern of terminal position areas

DIM	MILIMETERS		INCHES	
	MIN	MAX	MIN	MAX
A1	0.00	0.10	0	0.004
A	0.45	0.55	0.018	0.022
b	0.17	0.27	0.007	0.011
c	0.08	0.18	0.003	0.007
D	1.50	1.70	0.059	0.067
E	1.10	1.30	0.043	0.051
e	0.50		0.02	
HE	1.50	1.70	0.059	0.067
L	0.10	0.30	0.004	0.012
Lp	-	0.35	-	0.014
x	-	0.10	-	0.004
y	-	0.10	-	0.004

DIM	MILIMETERS		INCHES	
	MIN	MAX	MIN	MAX
e1	1.25		0.049	
b2	-	0.37	-	0.015
l1	-	0.45	-	0.018

Dimension in mm/inches

●Dimensions (Unit : mm)

UMT6

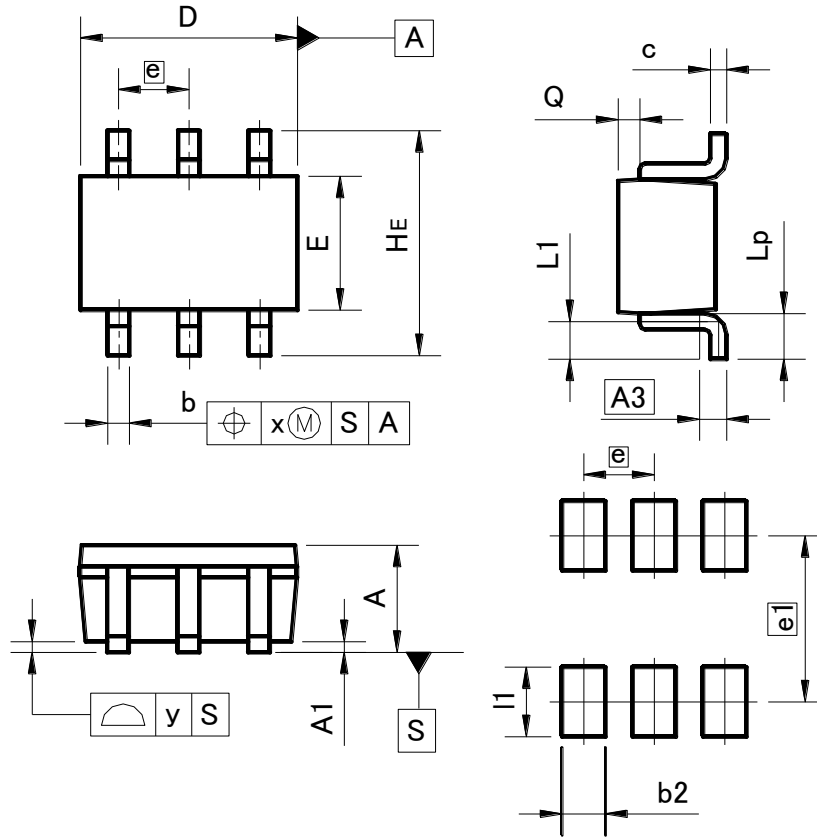

Pattern of terminal position areas

DIM	MILIMETERS		INCHES	
	MIN	MAX	MIN	MAX
A	0.80	1.00	-	0.039
A1	0.00	0.10	0	0.004
A3	0.25		0.01	
b	0.15	0.30	0.006	0.012
c	0.10	0.20	0.004	0.008
D	1.90	2.10	0.075	0.083
E	1.15	1.35	0.045	0.053
e	0.65		0.03	
HE	2.00	2.20	0.079	0.087
L1	0.20	0.50	0.008	0.02
Lp	0.25	0.55	0.01	0.022
Q	0.10	0.30	0.004	0.012
x	-	0.10	-	0.004
y	-	0.10	-	0.004

DIM	MILIMETERS		INCHES	
	MIN	MAX	MIN	MAX
e1	1.55		0.06	
b2	-	0.40	-	0.016
l1	-	0.65	-	0.026

Dimension in mm/inches

●Dimensions (Unit : mm)

SMT6

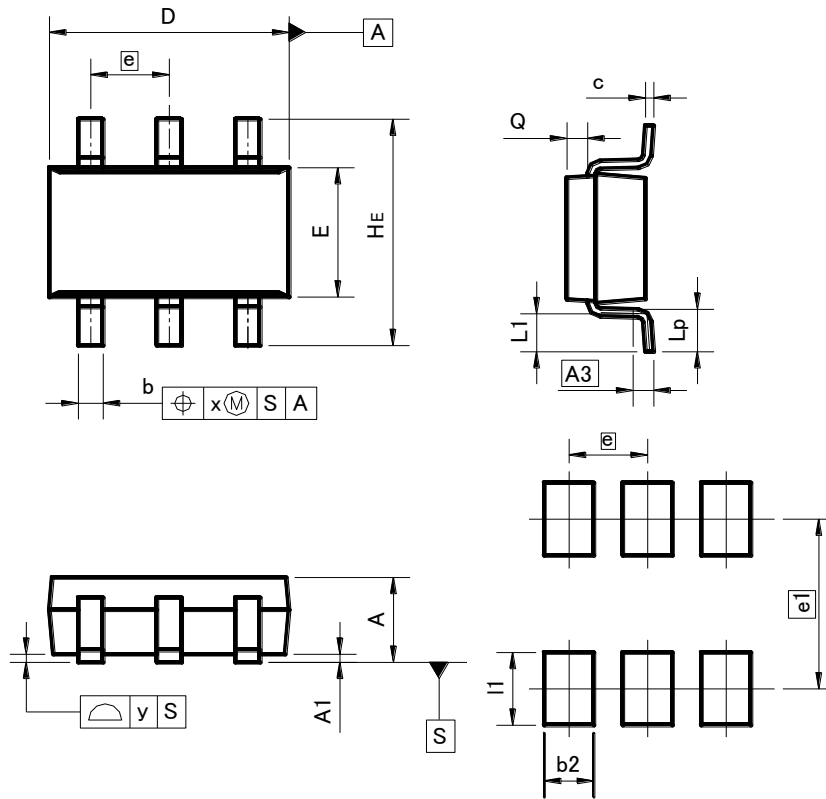

Pattern of terminal position areas

DIM	MILIMETERS		INCHES	
	MIN	MAX	MIN	MAX
A	1.00	1.30	0.039	0.051
A1	0.00	0.10	0	0.004
A3	0.25		0.01	
b	0.25	0.40	0.01	0.016
c	0.09	0.25	0.004	0.01
D	2.80	3.00	0.11	0.118
E	1.50	1.80	0.059	0.071
e	0.95		0.04	
HE	2.60	3.00	0.102	0.118
L1	0.30	0.60	0.012	0.024
Lp	0.40	0.70	0.016	0.028
Q	0.20	0.30	0.008	0.012
x	-	0.20	-	0.008
y	-	0.10	-	0.004

DIM	MILIMETERS		INCHES	
	MIN	MAX	MIN	MAX
e1	2.10		0.08	
b2	-	0.60	-	0.024
l1	-	0.90	-	0.035

Dimension in mm/inches

Notes

No copying or reproduction of this document, in part or in whole, is permitted without the consent of ROHM Co.,Ltd.

The content specified herein is subject to change for improvement without notice.

The content specified herein is for the purpose of introducing ROHM's products (hereinafter "Products"). If you wish to use any such Product, please be sure to refer to the specifications, which can be obtained from ROHM upon request.

Examples of application circuits, circuit constants and any other information contained herein illustrate the standard usage and operations of the Products. The peripheral conditions must be taken into account when designing circuits for mass production.

Great care was taken in ensuring the accuracy of the information specified in this document. However, should you incur any damage arising from any inaccuracy or misprint of such information, ROHM shall bear no responsibility for such damage.

The technical information specified herein is intended only to show the typical functions of and examples of application circuits for the Products. ROHM does not grant you, explicitly or implicitly, any license to use or exercise intellectual property or other rights held by ROHM and other parties. ROHM shall bear no responsibility whatsoever for any dispute arising from the use of such technical information.

The Products specified in this document are intended to be used with general-use electronic equipment or devices (such as audio visual equipment, office-automation equipment, communication devices, electronic appliances and amusement devices).

The Products specified in this document are not designed to be radiation tolerant.

While ROHM always makes efforts to enhance the quality and reliability of its Products, a Product may fail or malfunction for a variety of reasons.

Please be sure to implement in your equipment using the Products safety measures to guard against the possibility of physical injury, fire or any other damage caused in the event of the failure of any Product, such as derating, redundancy, fire control and fail-safe designs. ROHM shall bear no responsibility whatsoever for your use of any Product outside of the prescribed scope or not in accordance with the instruction manual.

The Products are not designed or manufactured to be used with any equipment, device or system which requires an extremely high level of reliability the failure or malfunction of which may result in a direct threat to human life or create a risk of human injury (such as a medical instrument, transportation equipment, aerospace machinery, nuclear-reactor controller, fuel-controller or other safety device). ROHM shall bear no responsibility in any way for use of any of the Products for the above special purposes. If a Product is intended to be used for any such special purpose, please contact a ROHM sales representative before purchasing.

If you intend to export or ship overseas any Product or technology specified herein that may be controlled under the Foreign Exchange and the Foreign Trade Law, you will be required to obtain a license or permit under the Law.



Thank you for your accessing to ROHM product informations.
More detail product informations and catalogs are available, please contact us.

ROHM Customer Support System

<http://www.rohm.com/contact/>