

Parameter	Value
$V_{CC}$	-50V
$I_{C(MAX.)}$	-100mA
$R_1$	22k $\Omega$
$R_2$	22k $\Omega$

### ●Features

- 1) Built-In Biasing Resistors,  $R_1 = R_2 = 22k\Omega$ .
- 2) Built-in bias resistors enable the configuration of an inverter circuit without connecting external input resistors (see equivalent circuit).
- 3) The bias resistors consist of thin-film resistors with complete isolation to allow negative biasing of the input. They also have the advantage of completely eliminating parasitic effects.
- 4) Only the on/off conditions need to be set for operation, making the circuit design easy.
- 5) Complementary NPN Types :DTC124E series
- 6) Complex transistors :UMA1N/ FMA1A (PNP type)
- 7) Lead Free/RoHS Compliant.

### ●Application

Switching circuit, Inverter circuit, Interface circuit, Driver circuit

### ●Packaging specifications

Part No.	Package	Package size (mm)	Taping code	Reel size (mm)	Tape width (mm)	Basic ordering unit (pcs)	Marking
DTA124EM	VMT3	1212	T2L	180	8	8,000	15
DTA124EEB	EMT3F	1616	TL	180	8	3,000	15
DTA124EE	EMT3	1616	TL	180	8	3,000	15
DTA124EUB	UMT3F	2021	TL	180	8	3,000	15
DTA124EUA	UMT3	2021	T106	180	8	3,000	15
DTA124EKA	SMT3	2928	T146	180	8	3,000	15

### ●Outline

<p>VMT3</p> <p>DTA124EM (SC-105AA)</p>	<p>EMT3F</p> <p>DTA124EEB (SC-89)</p>
<p>EMT3</p> <p>DTA124EE SOT-416 (SC-75A)</p>	<p>UMT3F</p> <p>DTA124EUB (SC-85)</p>
<p>UMT3</p> <p>DTA124EUA SOT-323 (SC-70)</p>	<p>SMT3</p> <p>DTA124EKA SOT-346 (SC-59)</p>

### ●Inner circuit

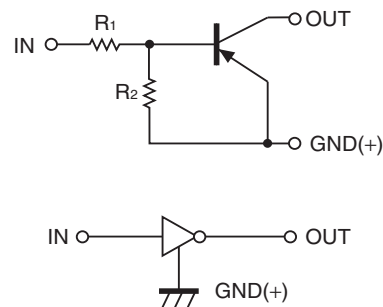

**●Absolute maximum ratings (Ta = 25°C)**

Parameter		Symbol	Values	Unit
Supply voltage		$V_{CC}$	-50	V
Input voltage		$V_{IN}$	-40 to +10	V
Output current		$I_O$	-30	mA
Collector current		$I_{C(MAX.)}^{*1}$	-100	mA
Power dissipation	DTA124EM DTA124EEB DTA124EE	$P_D^{*2}$	150	mW
	DTA124EUB DTA124EUA DTA124EKA		200	mW
Junction temperature		$T_j$	150	°C
Range of storage temperature		$T_{stg}$	-55 to +150	°C

**●Electrical characteristics (Ta = 25°C)**

Parameter	Symbol	Conditions	Min.	Typ.	Max.	Unit
Input voltage	$V_{I(off)}$	$V_{CC} = -5V, I_O = -100\mu A$	-	-	-0.5	V
	$V_{I(on)}$	$V_O = -0.2V, I_O = -5mA$	-3	-	-	
Output voltage	$V_{O(on)}$	$I_O / I_I = -10mA / -0.5mA$	-	-0.1	-0.3	V
Input current	$I_I$	$V_I = -5V$	-	-	-0.36	mA
Output current	$I_{O(off)}$	$V_{CC} = -50V, V_I = 0V$	-	-	-0.5	$\mu A$
DC current gain	$G_I$	$V_O = -5V, I_O = -5mA$	56	-	-	-
Input resistance	$R_1$	-	15.4	22	28.6	k $\Omega$
Resistance ratio	$R_2/R_1$	-	0.8	1	1.2	-
Transition frequency	$f_T^{*1}$	$V_{CE} = -10V, I_E = 5mA,$ $f = 100MHz$	-	250	-	MHz

\*1 Characteristics of built-in transistor

\*2 Each terminal mounted on a reference footprint

●Electrical characteristic curves(Ta = 25°C)

Fig.1 Input voltage vs. output current (ON characteristics)

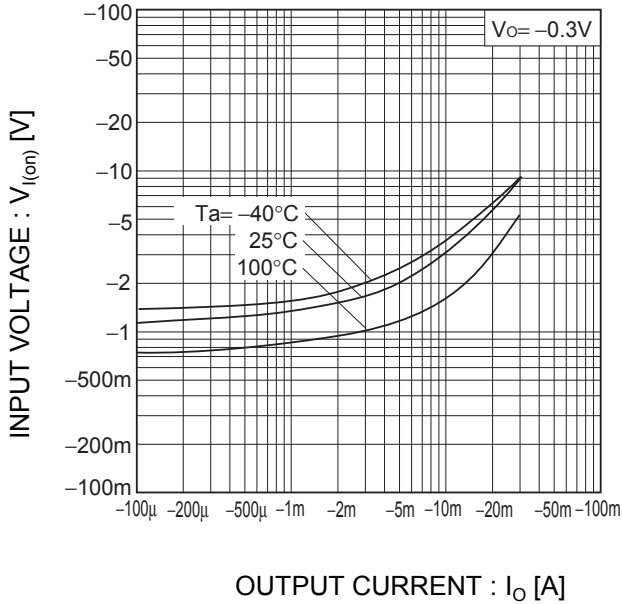

Fig.2 Output current vs. input voltage (OFF characteristics)

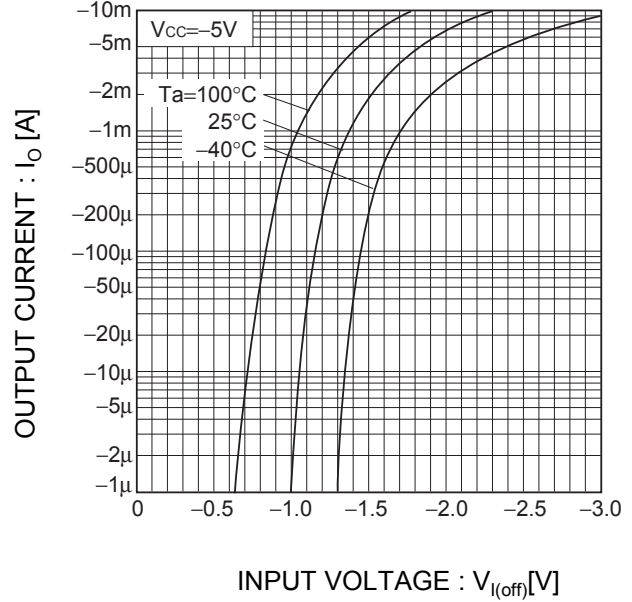

Fig.3 Output current vs. output voltage

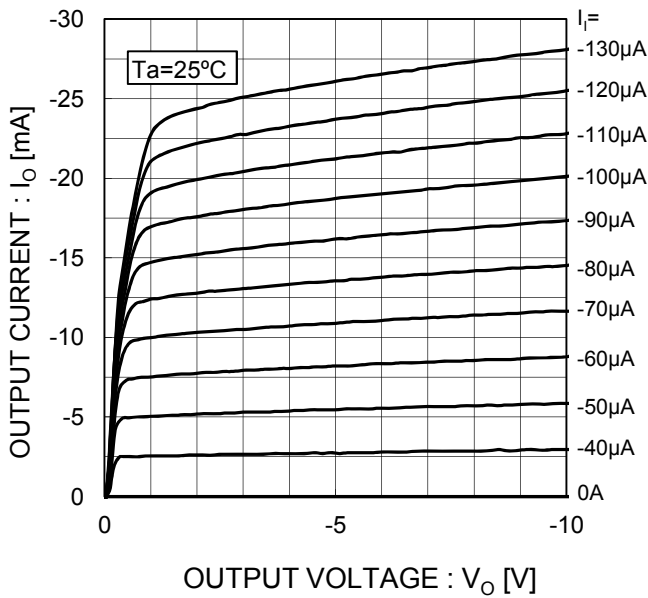
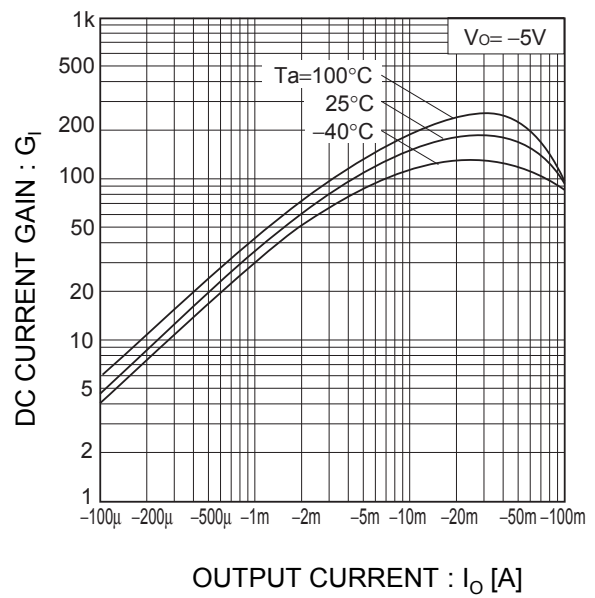
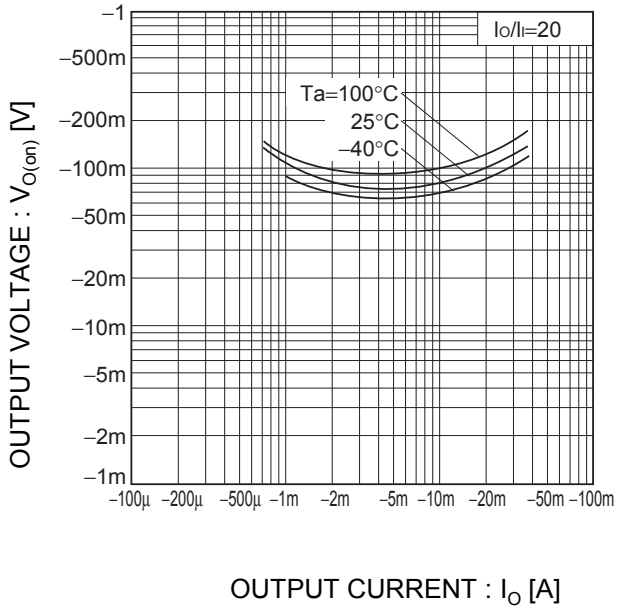

Fig.4 DC current gain vs. output current



●Electrical characteristic curves(Ta = 25°C)

Fig.5 Output voltage vs. output current



●Dimensions (Unit : mm)

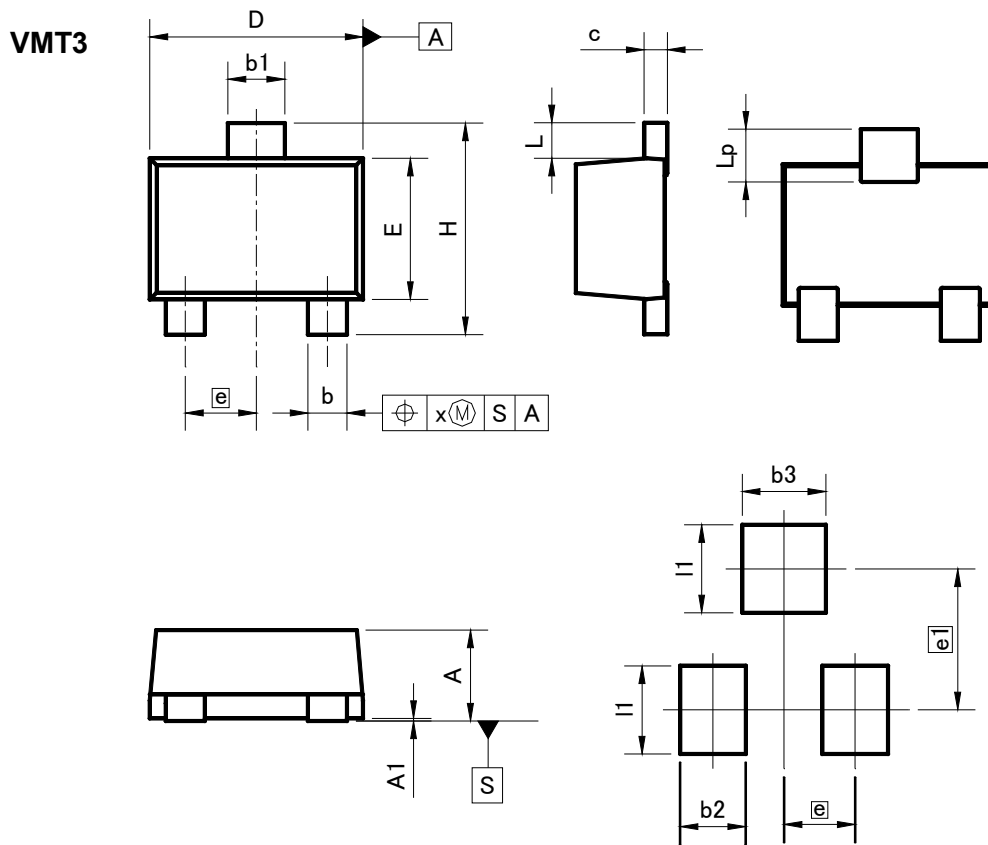

**Pattern of terminal position areas**

DIM	MILIMETERS		INCHES	
	MIN	MAX	MIN	MAX
A	0.45	0.55	0.018	0.022
A1	0.00	0.10	0	0.004
b	0.17	0.27	0.007	0.011
b1	0.27	0.37	0.011	0.015
c	0.08	0.18	0.003	0.007
D	1.10	1.30	0.043	0.051
E	0.70	0.90	0.028	0.035
e	0.40		0.02	
HE	1.10	1.30	0.043	0.051
L	0.10	0.30	0.004	-
Lp	0.20	0.40	0.008	-
x	-	0.10	-	0.004

DIM	MILIMETERS		INCHES	
	MIN	MAX	MIN	MAX
e1	0.80		0.03	
b2	-	0.37	-	0.015
b3	-	0.47	-	0.019
l1	-	0.50	-	0.02

Dimension in mm/inches

●Dimensions (Unit : mm)

EMT3F

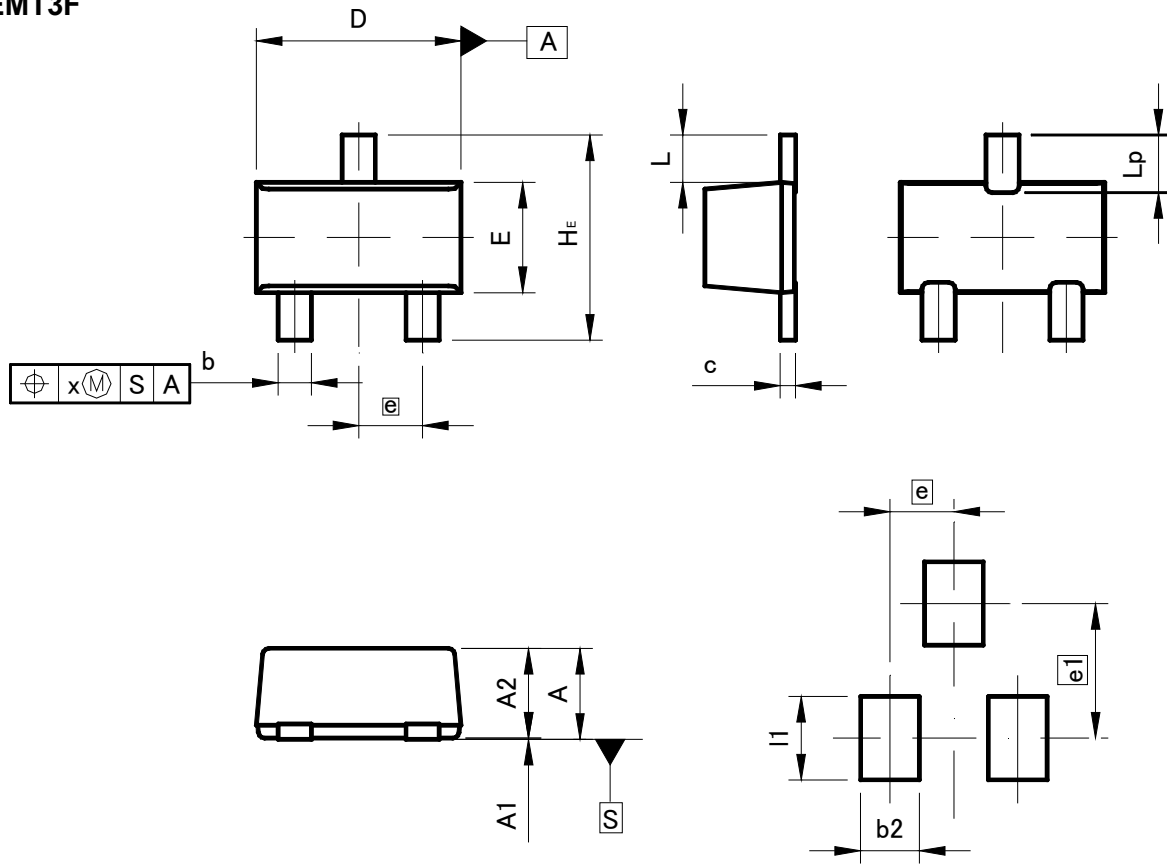

**Pattern of terminal position areas**

DIM	MILIMETERS		INCHES	
	MIN	MAX	MIN	MAX
A	0.65	0.85		
A1	0.00	0.10	0	0.004
A2	0.60	0.80	0.024	0.031
b	0.21	0.36	0.008	0.014
c	0.08	0.18	0.003	0.007
D	1.50	1.70	0.059	0.067
E	0.76	0.96	0.03	0.038
e	0.50		0.02	
HE	1.50	1.70	0.059	0.067
L	0.37		0.015	
Lp	0.35	0.55	0.014	0.022
x	-	0.10	-	0.004

DIM	MILIMETERS		INCHES	
	MIN	MAX	MIN	MAX
e1	-	1.05	-	0.041
b2	-	0.46	-	0.018
l1	-	0.65	-	0.026

Dimension in mm/inches

●Dimensions (Unit : mm)

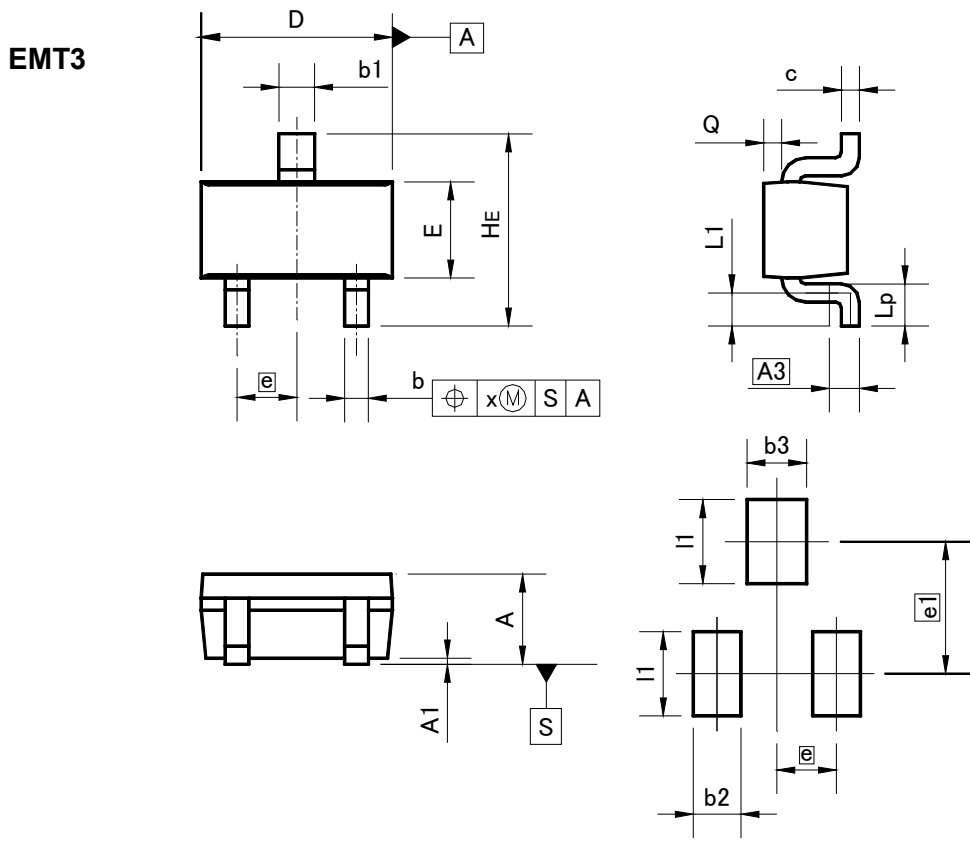

Pattern of terminal position areas

DIM	MILIMETERS		INCHES	
	MIN	MAX	MIN	MAX
A	0.60	0.80	0.024	0.031
A1	0.00	0.10	0	0.004
A3	0.25		0.01	
b	0.15	0.30	0.006	0.012
b1	0.25	0.40	0.01	0.016
c	0.10	0.20	0.004	0.008
D	1.50	1.70	0.059	0.067
E	0.70	0.90	0.028	0.035
e	0.50		0.02	
HE	1.40	1.80	0.055	0.071
L1	0.10	-	0.004	-
Lp	0.15	-	0.006	-
Q	0.05	0.25	0.002	0.01
x	-	0.10	-	0.004

DIM	MILIMETERS		INCHES	
	MIN	MAX	MIN	MAX
e1	1.10		0.04	
b2	-	0.40	-	0.016
b3	-	0.50	-	0.02
l1	-	0.70	-	0.028

Dimension in mm/inches

●Dimensions (Unit : mm)

UMT3F

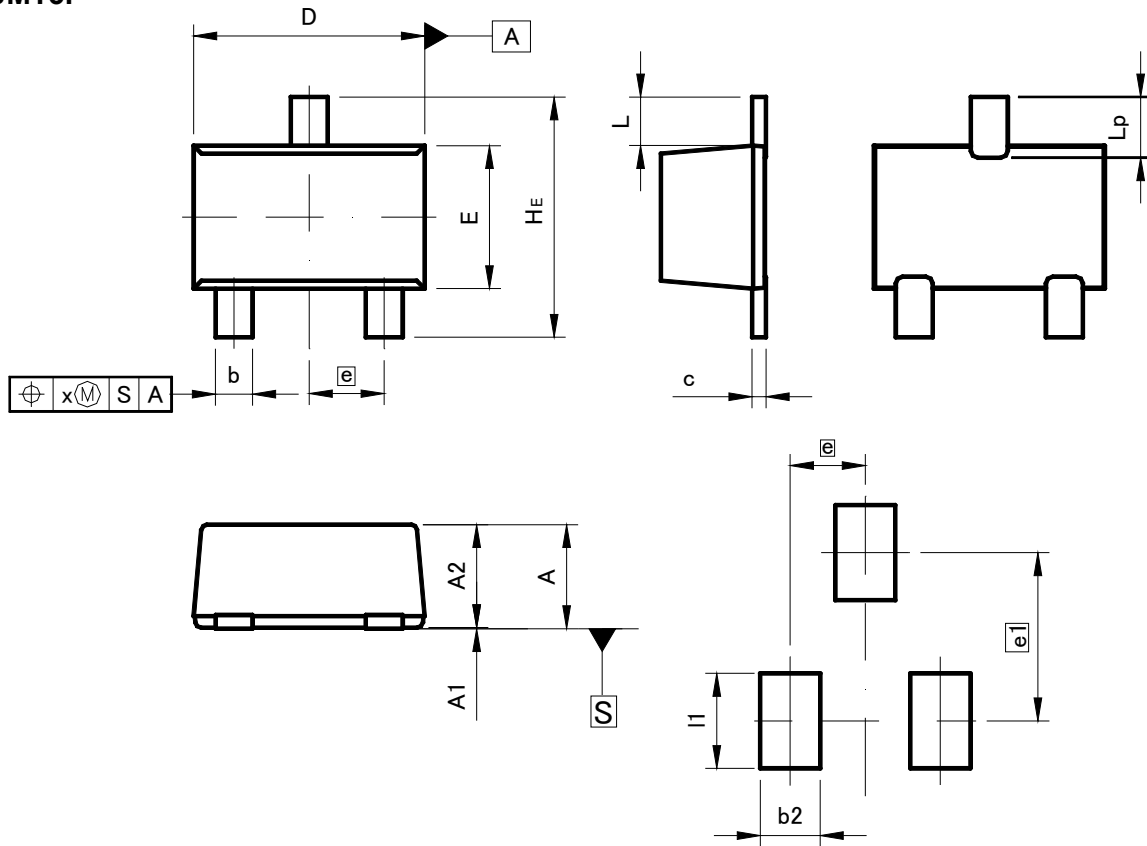

Pattern of terminal position areas

DIM	MILIMETERS		INCHES	
	MIN	MAX	MIN	MAX
A	0.85	1.05	0.033	0.041
A1	0.00	0.10	0	0.004
A2	0.80	1.00	0.031	0.039
b	0.27	0.42	0.011	0.017
c	0.08	0.18	0.003	0.007
D	1.90	2.10	0.075	0.083
E	1.15	1.35	0.045	0.053
e	0.65		0.03	
HE	2.00	2.20	0.079	0.087
L	0.425		0.02	
Lp	0.43	0.63	0.017	0.025
x	-	0.10	-	0.004

DIM	MILIMETERS		INCHES	
	MIN	MAX	MIN	MAX
e1	1.47		0.058	
b2	-	0.52	-	0.02
l1	-	0.83	-	0.033

Dimension in mm/inches

●Dimensions (Unit : mm)

UMT3

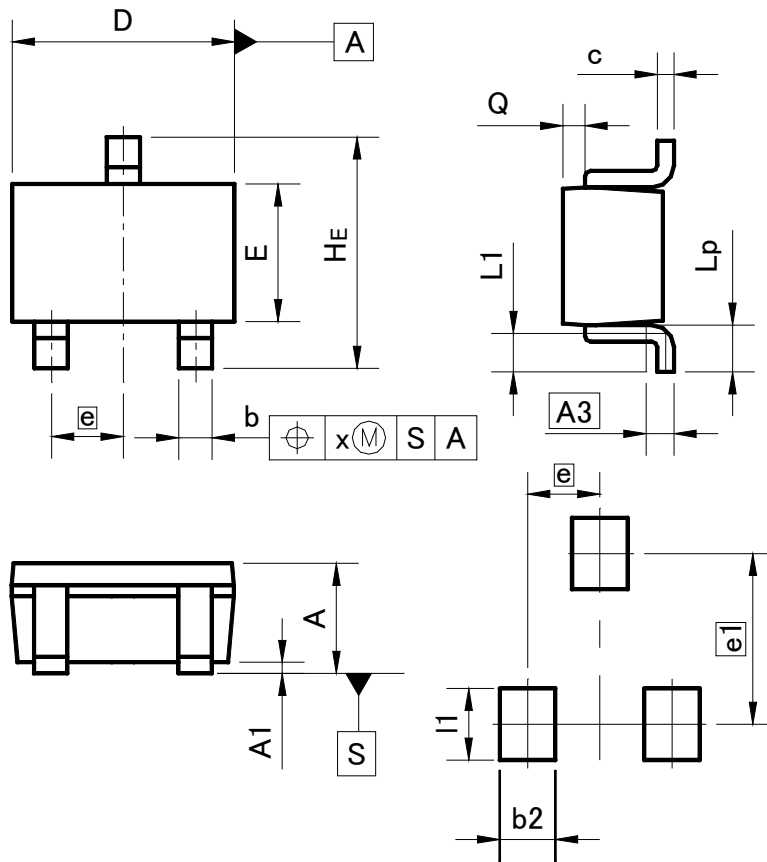

Pattern of terminal position areas

DIM	MILIMETERS		INCHES	
	MIN	MAX	MIN	MAX
A	0.80	1.00	0.031	0.039
A1	0.00	0.10	0	0.004
A3	0.25		0.01	
b	0.15	0.30	0.006	0.012
c	0.10	0.20	0.004	0.008
D	1.90	2.10	0.075	0.083
E	1.15	1.35	0.045	0.053
e	0.65		0.03	
HE	2.00	2.20	0.079	0.087
L1	0.20	0.50	0.008	0.02
Lp	0.25	0.55	0.01	0.022
Q	0.10	0.30	0.004	0.012
x	-	0.10	-	0.004

DIM	MILIMETERS		INCHES	
	MIN	MAX	MIN	MAX
e1	1.55		0.06	
b2	-	0.50	-	0.02
l1	-	0.65	-	0.026

Dimension in mm/inches

●Dimensions (Unit : mm)

SMT3

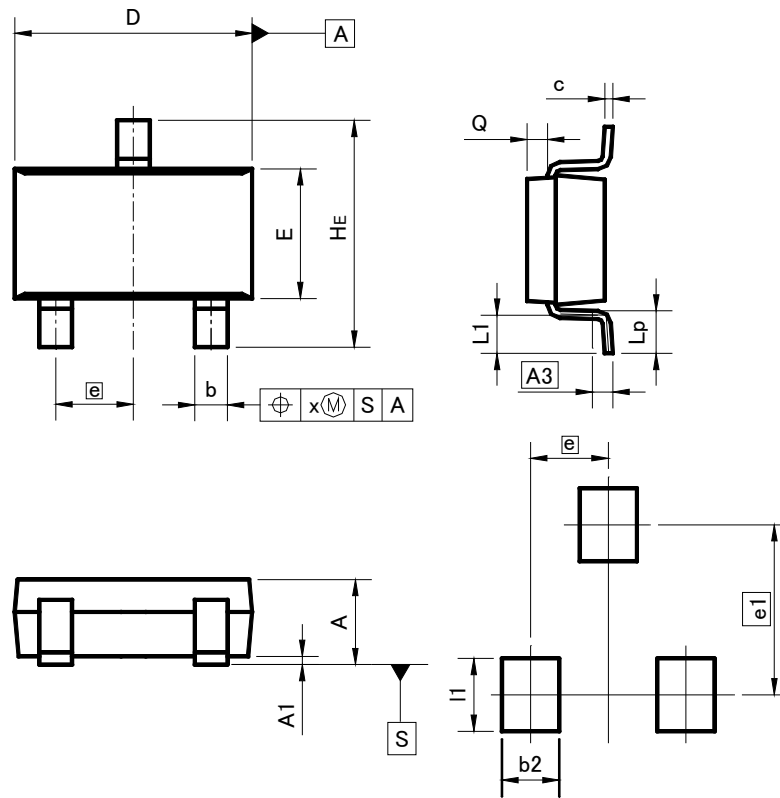

Pattern of terminal position areas

DIM	MILIMETERS		INCHES	
	MIN	MAX	MIN	MAX
A	1.00	1.30	-	0.051
A1	0.00	0.10	0	0.004
A3	0.25		0.01	
b	0.35	0.50	0.014	0.02
c	0.09	0.25	0.004	0.01
D	2.80	3.00	0.11	0.118
E	1.50	1.80	0.059	0.071
e	0.95		0.04	
HE	2.60	3.00	0.102	0.118
L1	0.30	0.60	0.012	0.024
Lp	0.40	0.70	0.016	0.028
Q	0.20	0.30	0.008	0.012
x	-	0.10	-	0.004
y	-	0.10	-	0.004

DIM	MILIMETERS		INCHES	
	MIN	MAX	MIN	MAX
e1	2.10		0.08	
b2	-	0.60	-	0.024
l1	-	0.90	-	0.035

Dimension in mm/inches

## Notes

No copying or reproduction of this document, in part or in whole, is permitted without the consent of ROHM Co.,Ltd.

The content specified herein is subject to change for improvement without notice.

The content specified herein is for the purpose of introducing ROHM's products (hereinafter "Products"). If you wish to use any such Product, please be sure to refer to the specifications, which can be obtained from ROHM upon request.

Examples of application circuits, circuit constants and any other information contained herein illustrate the standard usage and operations of the Products. The peripheral conditions must be taken into account when designing circuits for mass production.

Great care was taken in ensuring the accuracy of the information specified in this document. However, should you incur any damage arising from any inaccuracy or misprint of such information, ROHM shall bear no responsibility for such damage.

The technical information specified herein is intended only to show the typical functions of and examples of application circuits for the Products. ROHM does not grant you, explicitly or implicitly, any license to use or exercise intellectual property or other rights held by ROHM and other parties. ROHM shall bear no responsibility whatsoever for any dispute arising from the use of such technical information.

The Products specified in this document are intended to be used with general-use electronic equipment or devices (such as audio visual equipment, office-automation equipment, communication devices, electronic appliances and amusement devices).

The Products specified in this document are not designed to be radiation tolerant.

While ROHM always makes efforts to enhance the quality and reliability of its Products, a Product may fail or malfunction for a variety of reasons.

Please be sure to implement in your equipment using the Products safety measures to guard against the possibility of physical injury, fire or any other damage caused in the event of the failure of any Product, such as derating, redundancy, fire control and fail-safe designs. ROHM shall bear no responsibility whatsoever for your use of any Product outside of the prescribed scope or not in accordance with the instruction manual.

The Products are not designed or manufactured to be used with any equipment, device or system which requires an extremely high level of reliability the failure or malfunction of which may result in a direct threat to human life or create a risk of human injury (such as a medical instrument, transportation equipment, aerospace machinery, nuclear-reactor controller, fuel-controller or other safety device). ROHM shall bear no responsibility in any way for use of any of the Products for the above special purposes. If a Product is intended to be used for any such special purpose, please contact a ROHM sales representative before purchasing.

If you intend to export or ship overseas any Product or technology specified herein that may be controlled under the Foreign Exchange and the Foreign Trade Law, you will be required to obtain a license or permit under the Law.



Thank you for your accessing to ROHM product informations.  
More detail product informations and catalogs are available, please contact us.

### ROHM Customer Support System

<http://www.rohm.com/contact/>