

Reversible Motor Drivers for Brush Motors

1.0A or More Reversible Motor Drivers (2 Motors)



BA6247FP-Y, BA6238A

No.11008EBT04

●Description

The reversible motor driver for output 1.0A or more for two motors drives a brush motor and incorporates one and a half circuits of reversible motor driver. In addition, since the output section can control voltage applied to motors by output high voltage setting pin, the torque at the time of driving motors can be varied.

●Features

- 1) Built-in one and a half circuits of a reversible motor driver
- 2) Minimal external components
- 3) Output voltage can be optionally set by reference voltage setting pin
- 4) Built-in thermal shutdown circuit

●Applications

Audio-visual equipment; PC peripherals; Car audios; Car navigation systems; OA equipments

●Absolute maximum ratings (Ta=25°C, All voltages are with respect to ground)

Parameter	Symbol	Ratings		Unit
		BA6247FP-Y	BA6238A	
Supply voltage	VCC1, VCC2	20	20	V
Output current	I _{OMAX}	1* ¹	1.6* ¹	A
Control input pins	V _{IN}	-0.2 ~ 6.0	-0.3 ~ 5.0	V
Operating temperature	T _{OPR}	-25 ~ 75	-25 ~ 75	°C
Storage temperature	T _{STG}	-55 ~ 150	-55 ~ 125	°C
Power dissipation	Pd	1.45* ⁴	2.0* ² / 0.95* ³	W
Junction temperature	T _{Jmax}	150	125	°C

*1 Do not exceed Pd or ASO (Pulse at 1/50 duty: 50ms).

*2 HSIP10 package. Derated at 20mW/°C above 25°C.

*3 SIP10 package. Derated at 9.5mW/°C above 25°C.

*4 HSOP25 package. Mounted on a 70mm x 70mm x 1.6mm FR4 glass-epoxy board with less than 3% copper foil. Derated at 11.6mW/°C above 25°C.

●Operating conditions (Ta=25°C)

Parameter	Symbol	Ratings		Unit
		BA6247FP-Y	BA6238A	
Supply voltage	VCC1,	8 ~ 18	8 ~ 18	V
Supply voltage	VCC2	8 ~ 18	8 ~ 18	V
VREF voltage	VR	0 ~ 18	0 ~ 18	V

● **Electrical characteristics** (BA6247FP-Y, unless otherwise specified, Ta=25°C and VCC1=VCC2=12V)

Parameter	Symbol	Limits			Unit	Conditions
		Min.	Typ.	Max.		
Supply current	I _{CC}	-	10	20	mA	IN1, IN2, IN3=L
Input threshold voltage H	V _{IH}	3.5	-	-	V	
Input threshold voltage L	V _{IL}	-	-	1.0	V	
Output voltage H	V _{OH}	10	10.5	-	V	I _O =0.5A, VR=OPEN
Output voltage L	V _{OL}	-	0.9	1.5	V	I _O =0.5A
Output leak current	I _{OL}	-	-	1	mA	IN1, IN2, IN3=L, VCC2 current
Output offset voltage	V _{OFS}	-0.5	0	0.5	V	VR=6V, I _O =0.5A, V _{OH} -VR
VR bias current	I ₈	0.5	0.8	1.6	mA	VR=6V, I _O =0.5A

● **Electrical characteristics** (BA6238A, unless otherwise specified, Ta=25°C and VCC1=VCC2=12V)

Parameter	Symbol	Limits			Unit	Conditions
		Min.	Typ.	Max.		
Supply current	I _{CC}	-	12	24	mA	IN1, IN2, IN3=L, R _L =∞
Input threshold voltage H	V _{IH}	4.0	-	-	V	
Input threshold voltage L	V _{IL}	-	-	1.0	V	
Output voltage H	V _{OH}	10.0	10.5	-	V	I _O =0.5A, VR=OPEN
Output voltage L	V _{OL}	-	0.8	1.5	V	I _O =0.5A, VR=OPEN
Output leak current	I _{OL}	-	-	1	mA	IN1, IN2, IN3=L, R _L =∞, VCC2 current
Output offset voltage	V _{OFS}	-0.5	0	0.5	V	VR=6V, I _O =0.5A, V _{OH} -VR
VR bias current	I ₈	0.2	0.6	1.5	mA	VR=6V, I _O =0.5A

●Electrical characteristic curves (Reference data)

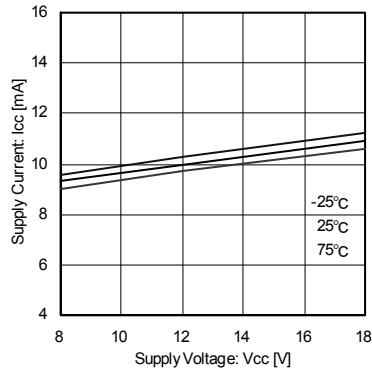

Fig.1 Supply current (BA6247FP-Y)

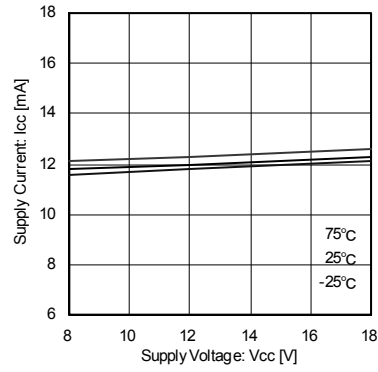

Fig.2 Supply current (BA6238A)

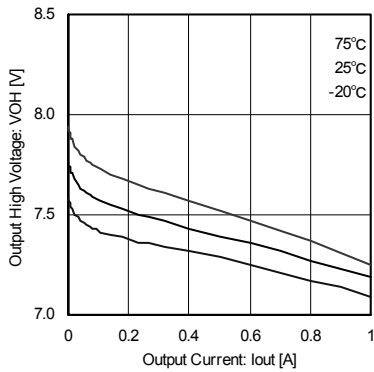

Fig.3 Output high voltage (BA6247FP-Y)

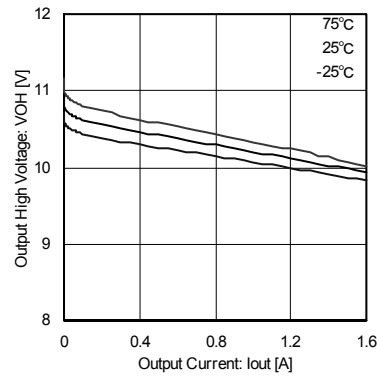

Fig.4 Output high voltage (BA6238A)

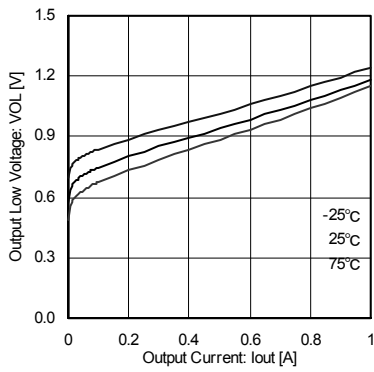

Fig.5 Output low voltage (BA6247FP-Y)

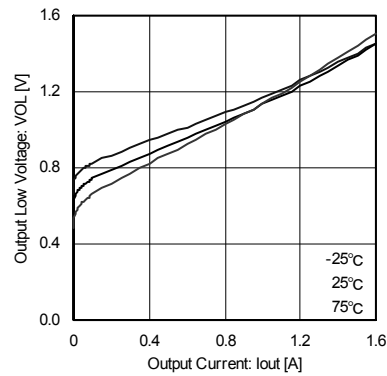

Fig.6 Output low voltage (BA6238A)

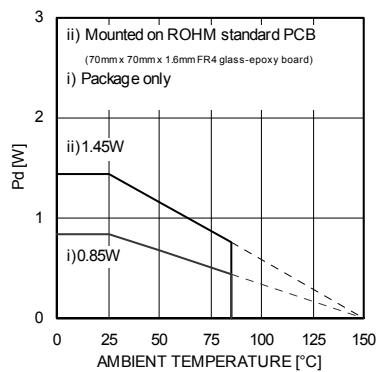

Fig.7 Thermal derating curve (BA6247FP-Y, HSOP25)

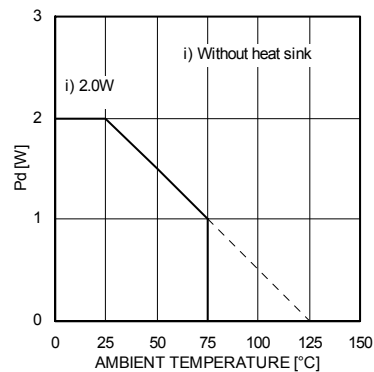

Fig.8 Thermal derating curve (BA6238A, HSIP10)

●Block diagram and pin configuration

BA6247FP-Y

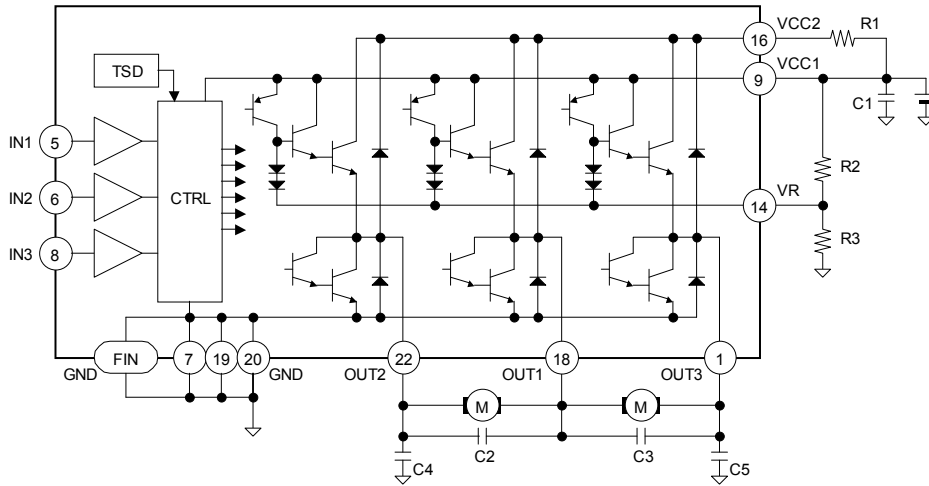

Fig.9 BA6247FP-Y

Table 1 BA6247FP-Y

Pin	Name	Function
1	OUT3	Driver output
2	NC	NC
3	NC	NC
4	NC	NC
5	IN1	Control input
6	IN2	Control input
7	GND	GND
8	IN3	Control input
9	VCC1	Power supply (small signal)
10	NC	NC
11	NC	NC
12	NC	NC
13	NC	NC
14	VR	Reference voltage setting pin
15	NC	NC
16	VCC2	Power supply (driver stage)
17	NC	NC
18	OUT1	Driver output
19	GND	GND
20	GND	GND
21	NC	NC
22	OUT2	Driver output
23	NC	NC
24	NC	NC
25	NC	NC
FIN	GND	GND

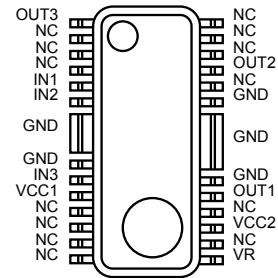

Fig.10 BA6247FP-Y (HSOP25)

●Block diagram and pin configuration

BA6238A

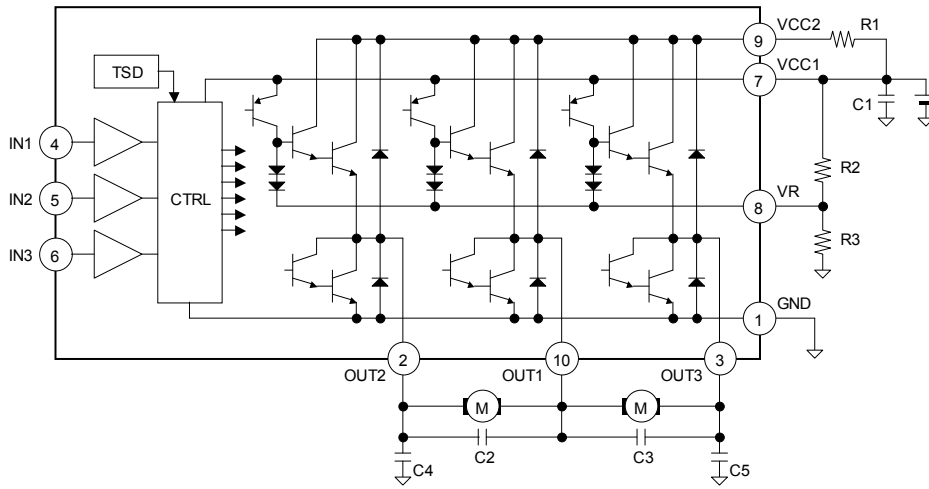

Fig.11 BA6238A

Table 2 BA6238A

Pin	Name	Function
1	GND	GND
2	OUT2	Driver output
3	OUT3	Driver output
4	IN1	Control input
5	IN2	Control input
6	IN3	Control input
7	VCC1	Power supply (small signal)
8	VR	Reference voltage setting pin
9	VCC2	Power supply (driver stage)
10	OUT1	Driver output

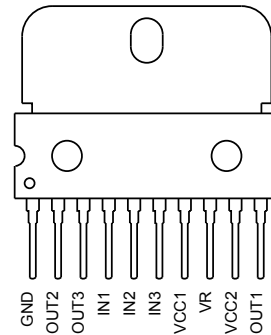

Fig.12 BA6238A (HSIP10)

●External application components

- 1) Resistor for the current limitation, R1
This is a current limiting resistor for collector loss reduction and at the time of short-circuited output. It depends on the power supply voltage used, etc., but choose resistance of about 5 to 10Ω. In addition, set resistance with utmost care to voltage drop caused by inrush current that flows when the motor is started.
- 2) Resistors and zener diode for the output high voltage setting, R2, R3 and ZD
These are the resistors and zener diode used when output high voltage is set. Zener diode ZD is recommended to be used instead of resistor R3 when the power supply voltage is unstable.
- 3) Stabilization capacitor for the power supply line, C1
Please connect the capacitor of 1μF to 100μF for the stabilization of the power supply line, and confirm the motor operation.
- 4) Phase compensating capacitor, C2, C3, C4, C5
Noise is generated in output pins or oscillation results in accord with the set mounting state such as power supply circuit, motor characteristics, PCB pattern artwork, etc. As noise oscillation measures, connect 0.01μF to 0.1μF capacitors.

●Functional descriptions

- 1) Operation modes

Table 3 Logic table, BA6247FP-Y / BA6238A

IN1	IN2	IN3	OUT1	OUT2	OUT3	OPERATION
L	L	L	L	L	L	Brake (stop)
		H				
H	L	L	H	L	OPEN*	Motor 1, forward (OUT1 > OUT2)
		H	L	H	OPEN*	Motor 1, reverse (OUT2 > OUT1)
L	H	L	H	OPEN*	L	Motor 2, forward (OUT1 > OUT3)
		H	L	OPEN*	H	Motor 2, reverse (OUT3 > OUT1)
H	H	L	L	L	L	Brake (stop)
		H				

* OPEN is the off state of all output transistors. Please note that this is the state of the connected diodes, which differs from that of the mechanical relay.

2) Output high voltage setting

This function optionally sets output voltage by the VR pin and controls the motor rotating speed. However, when the output high voltage is set to a low level, consumption at IC increases. Carry out thermal design with sufficient margin incorporated with the power dissipation (Pd) under the actual application condition taken into account. Please do not to exceed the VCC1 and VCC2 voltage forced to the VR pin voltage.

a) BA6247FP-Y

The circuit diagram associated with the output high voltage setting VR pin is as per shown on the right. The output high and low voltages V_{OH} and V_{OL} are expressed by:

$$V_{OH} = VR + (V_{F(Q5)} + V_{F(Q4)}) - (V_{F(Q2)} + V_{F(Q3)}) \approx VR$$

$$V_{OL} = V_{SAT(Q7)} + V_{F(Q6)}$$

(Reference values; $V_{SAT} \approx 0.2V$, $V_F \approx 0.7V$)

In addition, the relation of VREF voltage to output voltage is expressed by:

$$VR < VCC1 - V_{SAT(Q1)} - V_{F(Q4)} - V_{F(Q5)}$$

$$VR < VCC2 - V_{SAT(Q3)} + (V_{F(Q2)} + V_{F(Q3)}) - (V_{F(Q4)} + V_{F(Q5)})$$

Therefore, when the VR voltage condition is as follows, the output high voltage is restricted.

$$VR > VCC1 - V_{SAT(Q1)} - V_{F(Q4)} - V_{F(Q5)}$$

$$VR > VCC2 - V_{SAT(Q3)} + (V_{F(Q2)} + V_{F(Q3)}) - (V_{F(Q4)} + V_{F(Q5)})$$

$$V_{OH} = VCC1 - V_{SAT(Q1)} - V_{F(Q2)} - V_{F(Q3)}$$

$$V_{OH} = VCC2 - V_{SAT(Q3)}$$

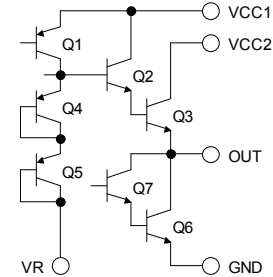

Fig.13 BA6247FP-Y

b) BA6238A

The circuit diagram associated with the output high voltage setting VR pin is as per shown on the right. The output high and low voltages V_{OH} and V_{OL} are expressed by:

$$V_{OH} = VR + (V_{F(Q5)} + V_{F(Q4)}) - (V_{F(Q2)} + V_{F(Q3)}) \approx VR$$

$$V_{OL} = V_{SAT(Q7)} + V_{F(Q6)}$$

(Reference values; $V_{SAT} \approx 0.1V$, $V_F \approx 0.7V$)

In addition, the relation of VREF voltage to output voltage is expressed by:

$$VR < VCC1 - V_{SAT(Q1)} - V_{F(Q4)} - V_{F(Q5)}$$

$$VR < VCC2 - (V_{SAT(Q2)} + V_{F(Q3)}) + (V_{F(Q2)} + V_{F(Q3)}) - (V_{F(Q4)} + V_{F(Q5)})$$

Therefore, when the VREF voltage condition is as follows, the output high voltage is restricted.

$$VR > VCC1 - V_{SAT(Q1)} - V_{F(Q4)} - V_{F(Q5)}$$

$$VR > VCC2 - (V_{SAT(Q2)} + V_{F(Q3)}) + (V_{F(Q2)} + V_{F(Q3)}) - (V_{F(Q4)} + V_{F(Q5)})$$

$$V_{OH} = VCC1 - V_{SAT(Q1)} - V_{F(Q2)} - V_{F(Q3)}$$

$$V_{OH} = VCC2 - V_{SAT(Q2)} - V_{F(Q3)}$$

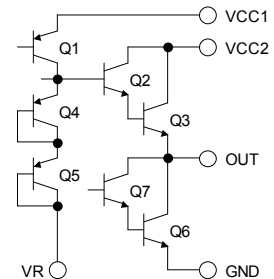

Fig.14 BA6238A

3) Control input conditions

The input threshold voltage has a positive temperature coefficient and is expressed by:

$$\frac{\Delta V_{IH}}{\Delta T} = +2.8\text{mV} / ^\circ\text{C} \quad \frac{\Delta V_{IL}}{\Delta T} = +1.6\text{mV} / ^\circ\text{C}$$

The input pin is pulled up at about 15kΩ.

Set input voltage with care not to exceed the maximum input voltage (internal voltage regulator).

BA6247FP-Y ... 6V
 BA6238A ... 5V

4) Switching of rotating direction (FWD/REV)

When the rotating direction is changed over by the motor rotating condition, switch the direction after the motor is temporarily brought to the BRAKE condition or OPEN condition. It is recommended to keep the relevant conditions as follows:

via BRAKE: Longer than braking time*.

(* the time required for the output L terminal to achieve potential below GND when brake is activated.)

The motor in no drive might be influenced momentarily because the all driver outputs low at the brake.

● Interfaces

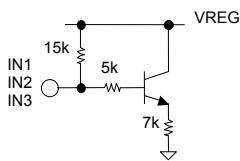

Fig. 15 IN1, IN2, IN3

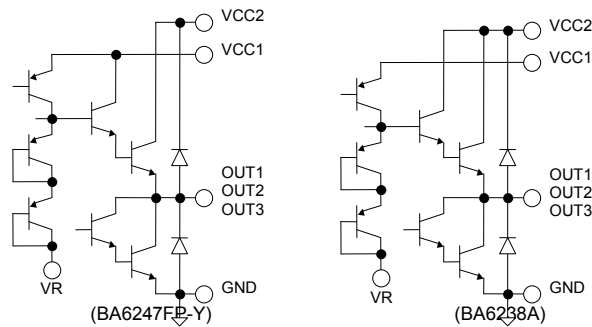

Fig.16 VCC1, VCC2, OUT1, OUT2, OUT3, VR, GND

●Notes for use

1) Absolute maximum ratings

Devices may be destroyed when supply voltage or operating temperature exceeds the absolute maximum rating. Because the cause of this damage cannot be identified as, for example, a short circuit or an open circuit, it is important to consider circuit protection measures – such as adding fuses – if any value in excess of absolute maximum ratings is to be implemented.

2) Connecting the power supply connector backward

Connecting the power supply in reverse polarity can damage the IC. Take precautions against reverse polarity when connecting the power supply lines, such as adding an external direction diode.

3) Power supply lines

Return current generated by the motor's Back-EMF requires countermeasures, such as providing a return current path by inserting capacitors across the power supply and GND (10 μ F, ceramic capacitor is recommended). In this case, it is important to conclusively confirm that none of the negative effects sometimes seen with electrolytic capacitors – including a capacitance drop at low temperatures - occurs. Also, the connected power supply must have sufficient current absorbing capability. Otherwise, the regenerated current will increase voltage on the power supply line, which may in turn cause problems with the product, including peripheral circuits exceeding the absolute maximum rating. To help protect against damage or degradation, physical safety measures should be taken, such as providing a voltage clamping diode across the power supply and GND.

4) Electrical potential at GND

Keep the GND terminal potential to the minimum potential under any operating condition. In addition, check to determine whether there is any terminal that provides voltage below GND, including the voltage during transient phenomena. When both a small signal GND and high current GND are present, single-point grounding (at the set's reference point) is recommended, in order to separate the small signal and high current GND, and to ensure that voltage changes due to the wiring resistance and high current do not affect the voltage at the small signal GND. In the same way, care must be taken to avoid changes in the GND wire pattern in any external connected component.

5) Thermal design

Use a thermal design that allows for a sufficient margin in light of the power dissipation (Pd) under actual operating conditions.

6) Inter-pin shorts and mounting errors

Use caution when positioning the IC for mounting on printed circuit boards. The IC may be damaged if there is any connection error, or if pins are shorted together.

7) Operation in strong electromagnetic fields

Using this product in strong electromagnetic fields may cause IC malfunctions. Use extreme caution with electromagnetic fields.

8) ASO - Area of Safety Operation

When using the IC, set the output transistor so that it does not exceed absolute maximum ratings or ASO.

9) Built-in thermal shutdown (TSD) circuit

The TSD circuit is designed only to shut the IC off - when BA6238A driver outputs low - to prevent thermal runaway. It is not designed to protect the IC or guarantee its operation in the presence of extreme heat. Do not continue to use the IC after the TSD circuit is activated, and do not operate the IC in an environment where activation of the circuit is assumed.

	BA6247FP-Y	BA6238A
T _{ON} [°C]	170	150
T _{HYS} [°C]	30	50

*All temperature values are typical.

10) Capacitor between output and GND

In the event a large capacitor is connected between the output and GND, if VCC and VIN are short-circuited with 0V or GND for any reason, the current charged in the capacitor flows into the output and may destroy the IC. Use a capacitor smaller than 1 μ F between output and GND.

11) Testing on application boards

When testing the IC on an application board, connecting a capacitor to a low impedance pin subjects the IC to stress. Therefore, always discharge capacitors after each process or step. Always turn the IC's power supply off before connecting it to or removing it from the test setup during the inspection process. Ground the IC during assembly steps as an antistatic measure. Use similar precaution when transporting or storing the IC.

12) Switching of rotating direction (FWD/REV)

When the rotating direction is changed over by the motor rotating condition, switch the direction after the motor is temporarily brought to the BRAKE condition or OPEN condition. It is recommended to keep the relevant conditions as follows:

via BRAKE: Longer than braking time*.

(* the time required for the output L terminal to achieve potential below GND when brake is activated.)

13) Regarding the input pin of the IC

This monolithic IC contains P+ isolation and P substrate layers between adjacent elements, in order to keep them isolated. P-N junctions are formed at the intersection of these P layers with the N layers of other elements, creating a parasitic diode or transistor. For example, the relation between each potential is as follows:

When $GND > Pin\ A$ and $GND > Pin\ B$, the P-N junction operates as a parasitic diode.

When $GND > Pin\ B$, the P-N junction operates as a parasitic transistor.

Parasitic diodes inevitably occur in the structure of the IC. The operation of parasitic diodes can result in mutual interference among circuits, as well as operating malfunctions and physical damage. Therefore, do not use methods by which parasitic diodes operate, such as applying a voltage lower than the GND (P substrate) voltage to an input pin.

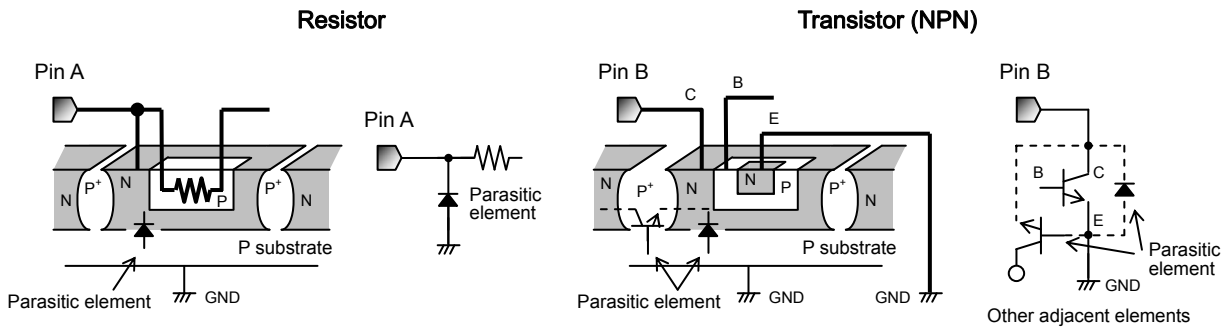
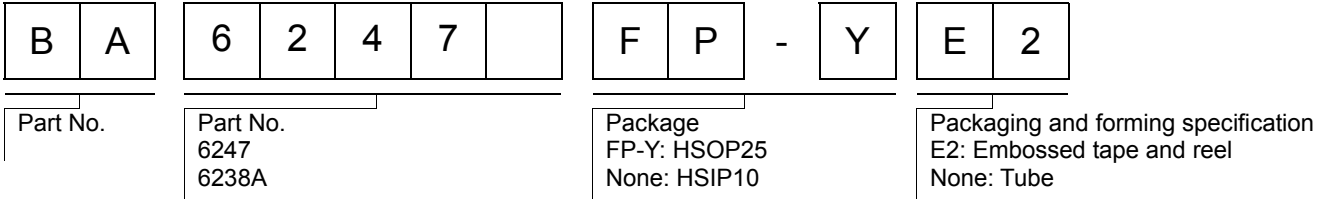
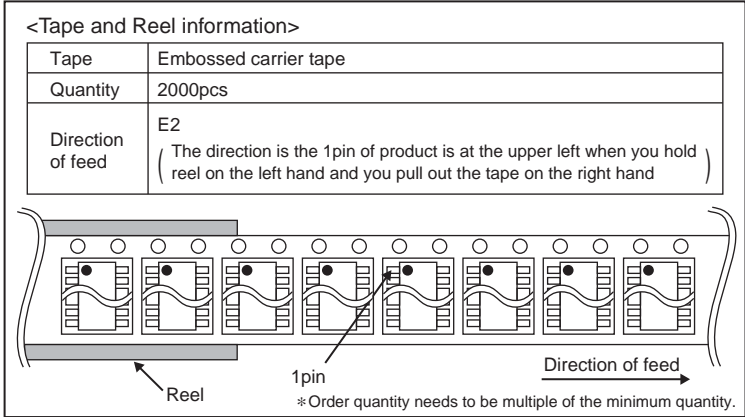
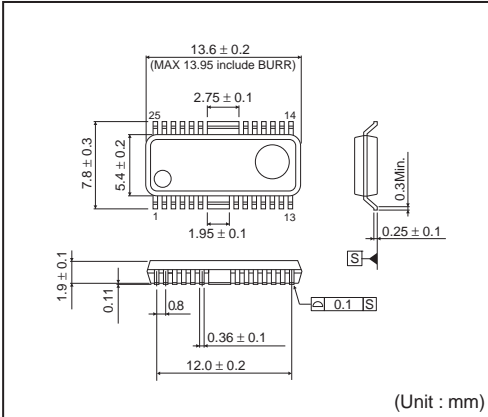

Fig.17 Example of monolithic IC structure

●Ordering part number



HSOP25



HSIP10

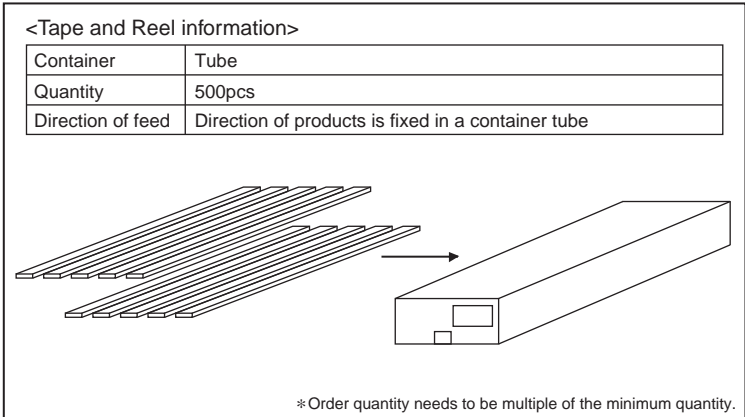
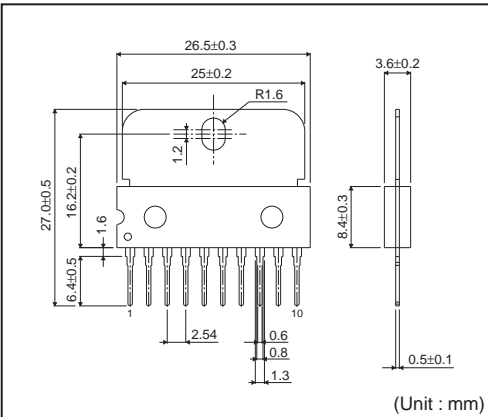

Notes

No copying or reproduction of this document, in part or in whole, is permitted without the consent of ROHM Co.,Ltd.

The content specified herein is subject to change for improvement without notice.

The content specified herein is for the purpose of introducing ROHM's products (hereinafter "Products"). If you wish to use any such Product, please be sure to refer to the specifications, which can be obtained from ROHM upon request.

Examples of application circuits, circuit constants and any other information contained herein illustrate the standard usage and operations of the Products. The peripheral conditions must be taken into account when designing circuits for mass production.

Great care was taken in ensuring the accuracy of the information specified in this document. However, should you incur any damage arising from any inaccuracy or misprint of such information, ROHM shall bear no responsibility for such damage.

The technical information specified herein is intended only to show the typical functions of and examples of application circuits for the Products. ROHM does not grant you, explicitly or implicitly, any license to use or exercise intellectual property or other rights held by ROHM and other parties. ROHM shall bear no responsibility whatsoever for any dispute arising from the use of such technical information.

The Products specified in this document are intended to be used with general-use electronic equipment or devices (such as audio visual equipment, office-automation equipment, communication devices, electronic appliances and amusement devices).

The Products specified in this document are not designed to be radiation tolerant.

While ROHM always makes efforts to enhance the quality and reliability of its Products, a Product may fail or malfunction for a variety of reasons.

Please be sure to implement in your equipment using the Products safety measures to guard against the possibility of physical injury, fire or any other damage caused in the event of the failure of any Product, such as derating, redundancy, fire control and fail-safe designs. ROHM shall bear no responsibility whatsoever for your use of any Product outside of the prescribed scope or not in accordance with the instruction manual.

The Products are not designed or manufactured to be used with any equipment, device or system which requires an extremely high level of reliability the failure or malfunction of which may result in a direct threat to human life or create a risk of human injury (such as a medical instrument, transportation equipment, aerospace machinery, nuclear-reactor controller, fuel-controller or other safety device). ROHM shall bear no responsibility in any way for use of any of the Products for the above special purposes. If a Product is intended to be used for any such special purpose, please contact a ROHM sales representative before purchasing.

If you intend to export or ship overseas any Product or technology specified herein that may be controlled under the Foreign Exchange and the Foreign Trade Law, you will be required to obtain a license or permit under the Law.



Thank you for your accessing to ROHM product informations.
More detail product informations and catalogs are available, please contact us.

ROHM Customer Support System

<http://www.rohm.com/contact/>