

Agilent PNA Series Microwave Network Analyzers

Data Sheet

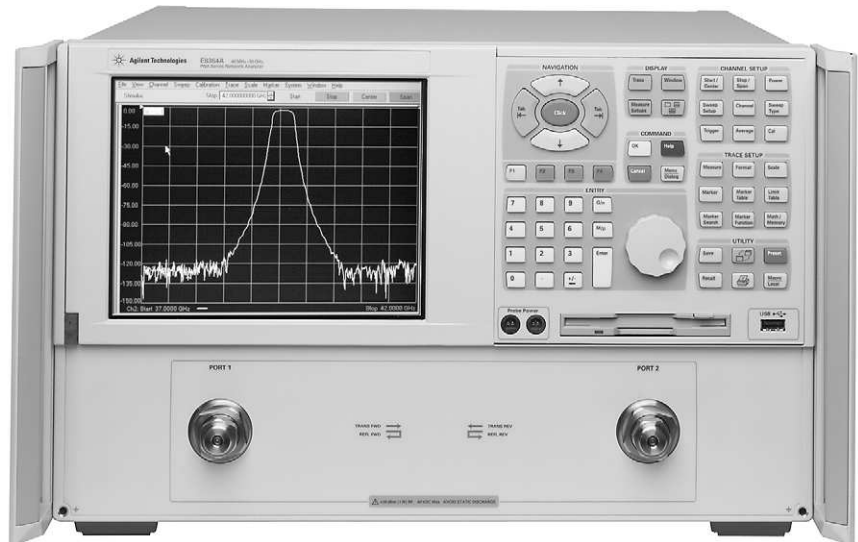

This document describes the performance and features of the Agilent Technologies PNA Series microwave vector network analyzers:

E8362A **45 MHz to 20 GHz**

E8363A **45 MHz to 40 GHz**

E8364A **45 MHz to 50 GHz**



Agilent Technologies

Some definitions

All specifications and characteristics apply over a 25°C ±5°C range (unless otherwise stated) and 90 minutes after the instrument has been turned on.

Calibration: The process of measuring known standards to characterize a network analyzer's systematic (repeatable) errors.

Characteristic (char.): A performance parameter that the product is expected to meet before it leaves the factory, but that is not verified in the field and is not covered by the product warranty. A characteristic includes the same guardbands as a specification.

Corrected (residual): Indicates performance after error correction (calibration). It is determined by the quality of calibration standards and how well "known" they are, plus system repeatability, stability, and noise.

Nominal (nom.): A general, descriptive term that does not imply a level of performance. It is not covered by the product warranty.

Specification (spec.): Warranted performance. Specifications include guardbands to account for the expected statistical performance distribution, measurement uncertainties, and changes in performance due to environmental conditions.

Standard: When referring to the analyzer, this includes no options unless noted otherwise.

Typical (typ.): Expected performance of an average unit, which does not include guardbands. It is not covered by the product warranty.

Uncorrected (raw): Indicates instrument performance without error correction. The uncorrected performance affects the stability of a calibration.

Table of contents

Corrected system performance	4
System dynamic range	4
Receiver dynamic range	5
Corrected system performance with 2.4 mm connectors	6
Corrected system performance with 3.5 mm connectors	10
Uncorrected system performance	14
Test port output	16
Test port input	17
General information	21
Measurement throughput summary	23
Cycle time vs. IF bandwidth	23
Cycle time vs. number of points	23
Cycle time	23
Data transfer time	24
PNA Series simplified test set block diagram ..	25
Measurement capabilities	27
Source control	27
Trace functions	28
Data accuracy enhancement	28
Storage	29
System capabilities	29
Automation	31
Information resources	32

Corrected system performance

The specifications in this section apply for measurements made with the Agilent E836xA PNA Series microwave network analyzer with the following conditions:

- 10-Hz IF bandwidth
- no averaging applied to data
- environmental temperature of 25°C ±5°C, with less than 1°C deviation from the calibration temperature
- isolation calibration with an averaging factor of 8

System dynamic range¹

Description	Specification (dB)	
	Typical (dB) at direct at test port ²	receiver access input ³
Dynamic range		
Standard configuration and standard power range (E836xA)		
45 to 500 MHz ⁴	94	N/A
500 MHz to 2 GHz	119	N/A
2 to 10 GHz	122	N/A
10 to 20 GHz	123	N/A
20 to 30 GHz	114	N/A
30 to 40 GHz	110	N/A
40 to 45 GHz	109	N/A
45 to 50 GHz	104	N/A
Extended configuration and standard power range (E836xA-Option 014)		
45 to 500 MHz ⁴	94	132
500 MHz to 2 GHz	119	138
2 to 10 GHz	122	137
10 to 20 GHz	121	136
20 to 30 GHz	111	123
30 to 40 GHz	107	119
40 to 45 GHz	105	116
45 to 50 GHz	100	111
Standard configuration and extended power range and bias-tees (E836xA-Option UNL)		
45 to 500 MHz ⁴	92	N/A
500 MHz to 2 GHz	117	N/A
2 to 10 GHz	120	N/A
10 to 20 GHz	121	N/A
20 to 30 GHz	112	N/A
30 to 40 GHz	108	N/A
40 to 45 GHz	105	N/A
45 to 50 GHz	99	N/A
Extended configuration and extended power range and bias-tees (E836xA-Option UNL and Option 014)		
45 to 500 MHz ⁴	92	130
500 MHz to 2 GHz	117	136
2 to 10 GHz	120	135
10 to 20 GHz	119	134
20 to 30 GHz	109	121
30 to 40 GHz	105	117
40 to 45 GHz	101	112
45 to 50 GHz	95	108

1. The system dynamic range is calculated as the difference between the noise floor and the source maximum output power. The effective dynamic range must take measurement uncertainties and interfering signals into account.
2. The test port system dynamic range is calculated as the difference between the test port noise floor and the source maximum output power. The effective dynamic range must take measurement uncertainties and interfering signals into account.
3. The direct receiver access input system dynamic range is calculated as the difference between the direct receiver access input noise floor and the source maximum output power. The effective dynamic range must take measurement uncertainties and interfering signals into account. This set-up should only be used when the receiver input will never exceed its damage level. When the analyzer is in segment sweep mode, the analyzer can have pre-defined frequency segments which will output a higher power level when the extended dynamic range is required (i.e. devices with high insertion loss), and reduced power when receiver damage may occur (i.e. devices with low insertion loss). The extended range is only available in one-path transmission measurements.
4. May be limited to 100 dB at particular frequencies below 500 MHz due to spurious receiver residuals. Methods are available to regain the full dynamic range.

Receiver dynamic range¹

Description	Specification (dB) at test port ²	Typical (dB) at direct receiver access input ³
Dynamic range		
Standard configuration and standard power range (E836xA) or standard configuration and extended power range and bias-tees (E836xA-Option UNL)		
45 to 500 MHz ⁴	94	N/A
500 MHz to 2 GHz	119	N/A
2 to 10 GHz	122	N/A
10 to 20 GHz	125	N/A
20 to 30 GHz	114	N/A
30 to 40 GHz	111	N/A
40 to 50 GHz	111	N/A
Extended configuration and standard power range (E836xA) or extended configuration and extended power range and bias-tees (E836xA-Option 014 and Option UNL)		
45 to 500 MHz ⁴	94	132
500 MHz to 2 GHz	119	138
2 to 10 GHz	122	137
10 to 20 GHz	124	139
20 to 40 GHz	113	125
40 to 45 GHz	110	122
45 to 50 GHz	109	120

1. The receiver dynamic range is calculated as the difference between the noise floor and the receiver maximum input level. The effective dynamic range must take measurement uncertainties and interfering signals into account.
2. The test port receiver dynamic range is calculated as the difference between the test port noise floor and the receiver maximum input level. The effective dynamic range must take measurement uncertainties and interfering signals into account.
3. The direct receiver access input receiver dynamic range is calculated as the difference between the direct receiver access input noise floor and the receiver maximum input level. The effective dynamic range must take measurement uncertainties and interfering signals into account. This set-up should only be used when the receiver input will never exceed its damage level. When the analyzer is in segment sweep mode, the analyzer can have pre-defined frequency segments which will output a higher power level when the extended dynamic range is required (i.e. devices with high insertion loss), and reduced power when receiver damage may occur (i.e. devices with low insertion loss). The extended range is only available in one-path transmission measurements.
4. May be limited to 100 dB at particular frequencies below 500 MHz due to spurious receiver residuals. Methods are available to regain the full dynamic range.

Corrected system performance with 2.4 mm connectors

Standard configuration and standard power range (E8363/4A)

Applies to E8363/4A PNA Series analyzer, 85056A (2.4 mm) calibration kit, 85133F flexible test port cable set, and a full two-port calibration. (Specifications apply over environmental temperature of 23° ±3°C, with less than 1°C deviation from calibration temperature.)

Description	Specification (dB)				
	0.045 kHz to 2 GHz	2 to 10 GHz	10 to 20 GHz	20 to 40 GHz	40 to 50 GHz
Directivity	42	42	42	38	36
Source match	41	38	38	33	31
Load match	42	42	42	37	35
Reflection tracking	±(0.001 + 0.2/°C)	±(0.008 + 0.2/°C)	±(0.008 + 0.2/°C)	±(0.020 + 0.3/°C)	±(0.027 + 0.4/°C)
Transmission tracking	±(0.014 + 0.2/°C)	±(0.033 + 0.2/°C)	±(0.039 + 0.2/°C)	±(0.105 + 0.3/°C)	±(0.200 + 0.4/°C)
Crosstalk (reflection port to transmission port: short circuits at both ports; isolation calibration applied)	< -85 (to 500 MHz)				
	< -100 (from 500 MHz)	< -110	< -110	< -110	< -110

Transmission uncertainty (specifications)

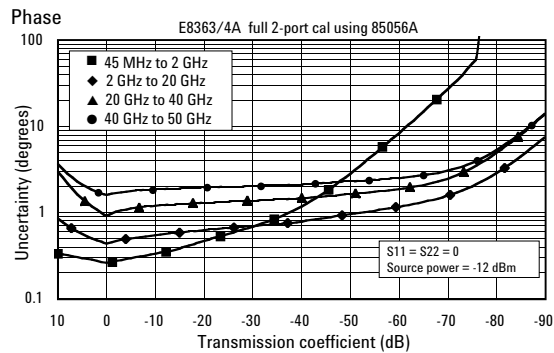
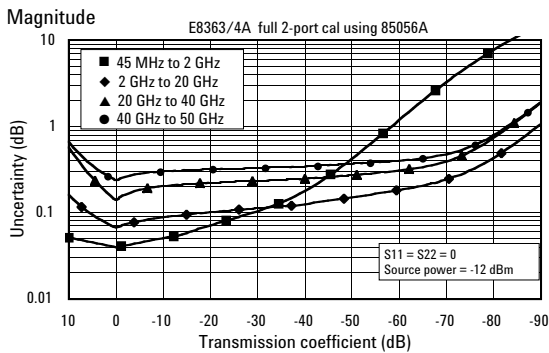

Reflection uncertainty (specifications)

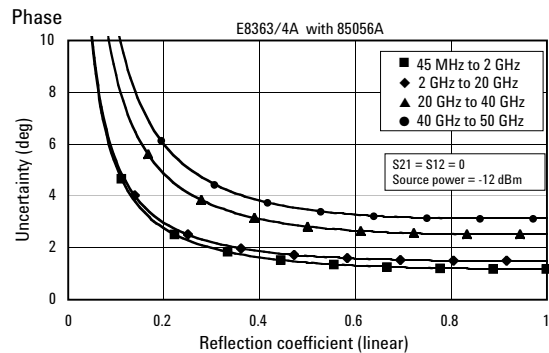
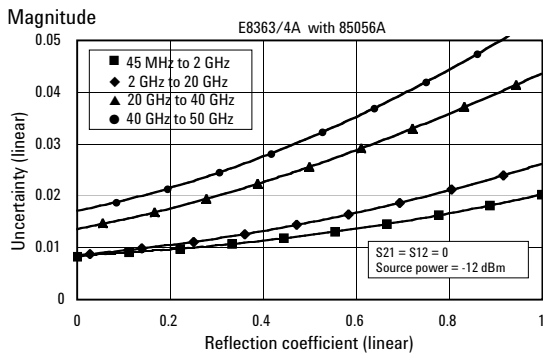

Extended configuration and standard power range (E8363/4A-Option 014)

Applies to E8363/4A PNA Series analyzer, 85056A (2.4 mm) calibration kit, 85133F flexible test port cable set, and a full two-port calibration. (Specifications apply over environmental temperature of 23° ±3°C, with less than 1°C deviation from calibration temperature.)

Description	Specification (dB)				
	0.045 kHz to 2 GHz	2 to 10 GHz	10 to 20 GHz	20 to 40 GHz	40 to 50 GHz
Directivity	42	42	42	38	36
Source match	41	38	38	33	31
Load match	42	42	42	37	35
Reflection tracking	±(0.001 + 0.2/°C)	±(0.008 + 0.2/°C)	±(0.008 + 0.2/°C)	±(0.020 + 0.3/°C)	±(0.027 + 0.4/°C)
Transmission tracking	±(0.019 + 0.2/°C)	±(0.039 + 0.2/°C)	±(0.053 + 0.2/°C)	±(0.114 + 0.3/°C)	±(0.215 + 0.4/°C)
Crosstalk (reflection port to transmission port: short circuits at both ports; isolation calibration applied)	< -85 (to 500 MHz)				
	< -100 (from 500 MHz)	< -110	< -110	< -110	< -110

Transmission uncertainty (specifications)

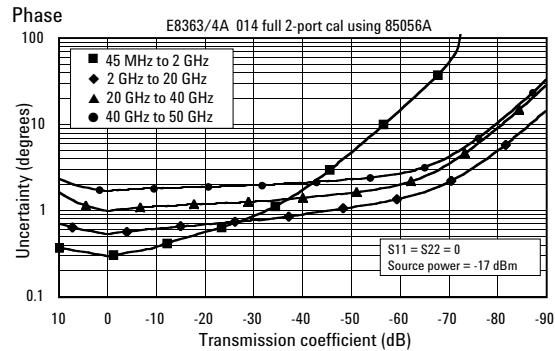
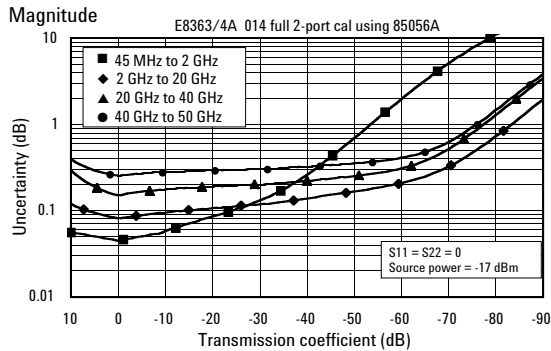

Reflection uncertainty (specifications)

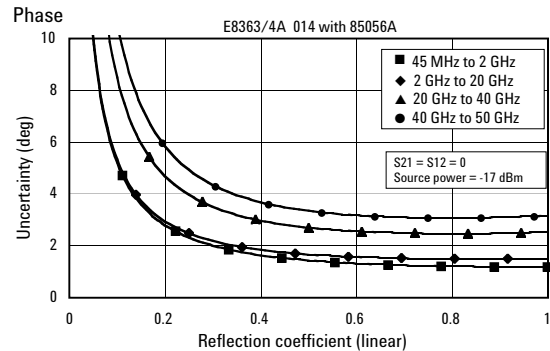
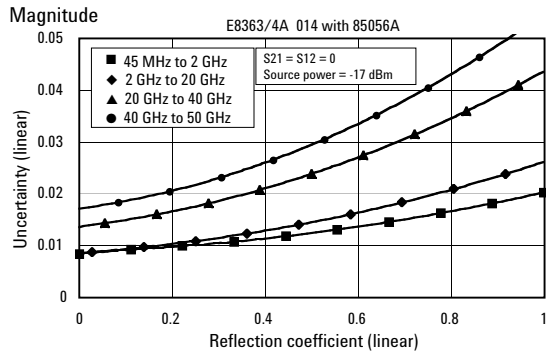

Corrected system performance with 2.4 mm connectors *continued*

Standard configuration and extended power range and bias-tees (E8363/4A-Option UNL)

Applies to E8363/4A PNA Series analyzer, 85056A (2.4 mm) calibration kit, 85133F flexible test port cable set, and a full two-port calibration. (Specifications apply over environmental temperature of 23° ±3°C, with less than 1°C deviation from calibration temperature.)

Description	Specification (dB)				
	0.045 kHz to 2 GHz	2 to 10 GHz	10 to 20 GHz	20 to 40 GHz	40 to 50 GHz
Directivity	42	42	42	38	36
Source match	41	38	38	33	31
Load match	42	42	42	37	35
Reflection tracking	±(0.001 + 0.2/°C)	±(0.008 + 0.2/°C)	±(0.008 + 0.2/°C)	±(0.020 + 0.3/°C)	±(0.027 + 0.4/°C)
Transmission tracking	±(0.019 + 0.2/°C)	±(0.039 + 0.2/°C)	±(0.053 + 0.2/°C)	±(0.114 + 0.3/°C)	±(0.215 + 0.4/°C)
Crosstalk (reflection port to transmission port: short circuits at both ports; isolation calibration applied)	< -85 (to 500 MHz)				
	< -100 (from 500 MHz)	< -110	< -110	< -110	< -110

Transmission uncertainty (specifications)

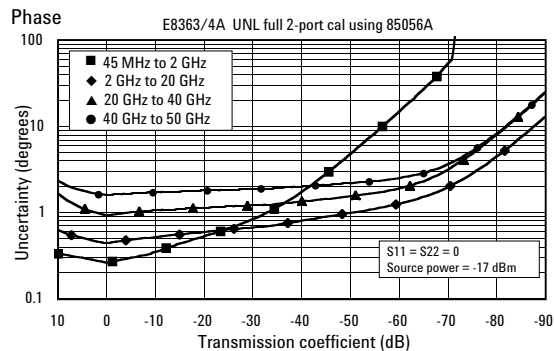
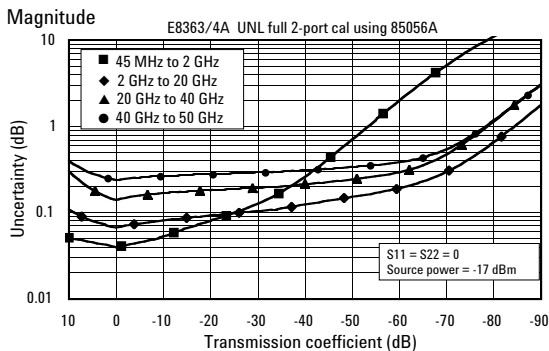

Reflection uncertainty (specifications)

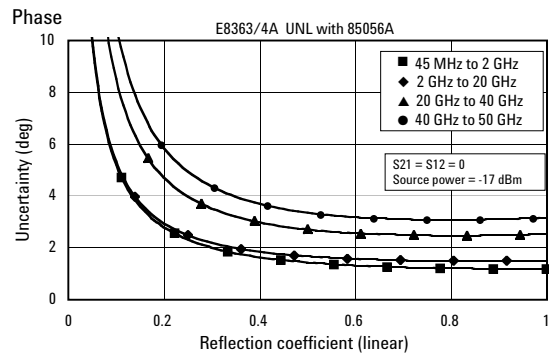
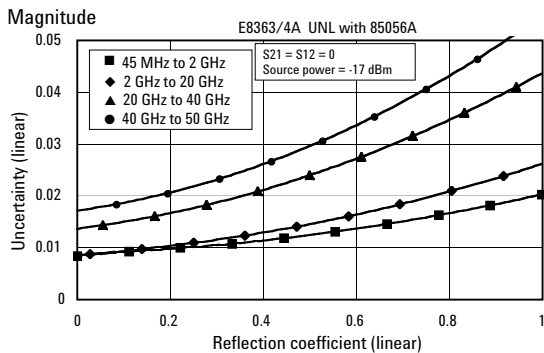

Extended configuration and extended power range and bias-tees (E8363/4A-Options UNL and 014)

Applies to E8363/4A PNA Series analyzer, 85056A (2.4 mm) calibration kit, 85133F flexible test port cable set, and a full two-port calibration. (Specifications apply over environmental temperature of 23° ±3°C, with less than 1°C deviation from calibration temperature.)

Description	Specification (dB)				
	0.045 kHz to 2 GHz	2 to 10 GHz	10 to 20 GHz	20 to 40 GHz	40 to 50 GHz
Directivity	42	42	42	38	36
Source match	41	38	38	33	31
Load match	42	42	42	37	35
Reflection tracking	±(0.001 + 0.2/°C)	±(0.008 + 0.2/°C)	±(0.008 + 0.2/°C)	±(0.020 + 0.3/°C)	±(0.027 + 0.4/°C)
Transmission tracking	±(0.019 + 0.2/°C)	±(0.039 + 0.2/°C)	±(0.053 + 0.2/°C)	±(0.114 + 0.3/°C)	±(0.215 + 0.4/°C)
Crosstalk (reflection port to transmission port: short circuits at both ports; isolation calibration applied)	< -85 (to 500 MHz)				
	< -100 (from 500 MHz)	< -110	< -110	< -110	< -110

Transmission uncertainty (specifications)

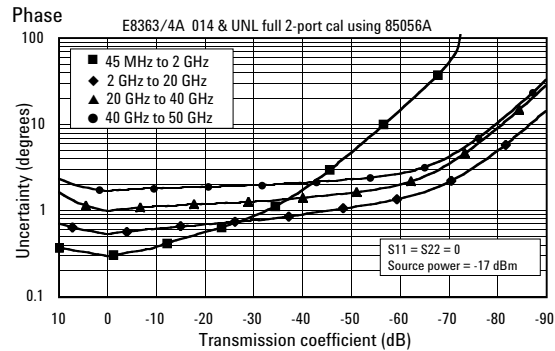
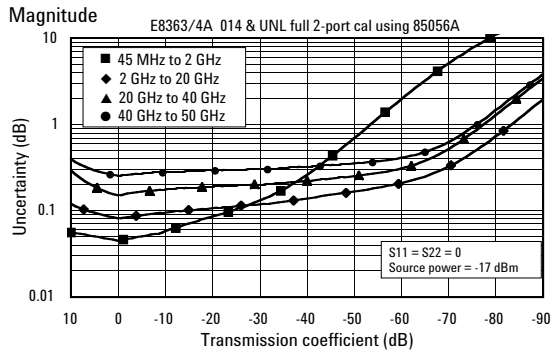

Reflection uncertainty (specifications)

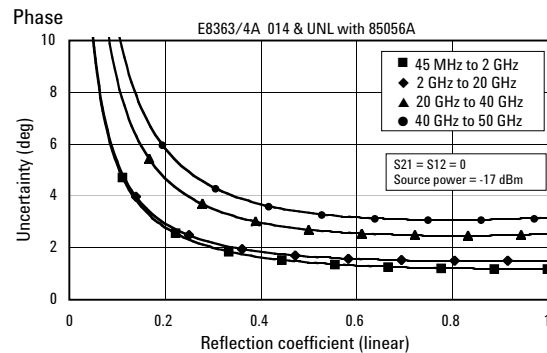
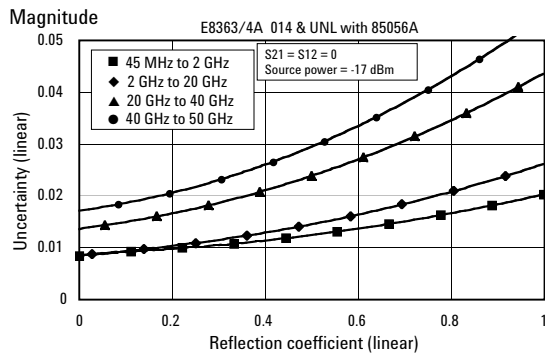

Corrected system performance with 3.5 mm connectors

Standard configuration and standard power range (E8362A)

Applies to E8362A PNA Series analyzer, 85052B (3.5 mm) calibration kit, 85131F flexible test port cable set, and a full two-port calibration. (Specifications apply over environmental temperature of $23^{\circ} \pm 3^{\circ}\text{C}$, with less than 1°C deviation from calibration temperature.)

Description	Specification (dB)			
	45 MHz to 500 MHz	500 MHz to 2 GHz	2 to 10 GHz	10 to 20 GHz
Directivity	48	48	44	44
Source match	40	40	31	31
Load match	48	48	44	44
Reflection tracking	$\pm(0.003 + 0.2/^{\circ}\text{C})$	$\pm(0.003 + 0.2/^{\circ}\text{C})$	$\pm(0.006 + 0.2/^{\circ}\text{C})$	$\pm(0.006 + 0.2/^{\circ}\text{C})$
Transmission tracking	$\pm(0.014 + 0.2/^{\circ}\text{C})$	$\pm(0.014 + 0.2/^{\circ}\text{C})$	$\pm(0.057 + 0.2/^{\circ}\text{C})$	$\pm(0.065 + 0.2/^{\circ}\text{C})$
Crosstalk (reflection port to transmission port: short circuits at both ports; isolation calibration applied)	< -85	< -100	< -110	< -100

Transmission uncertainty (specifications)

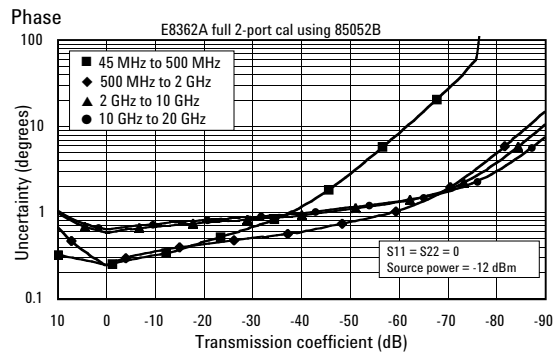
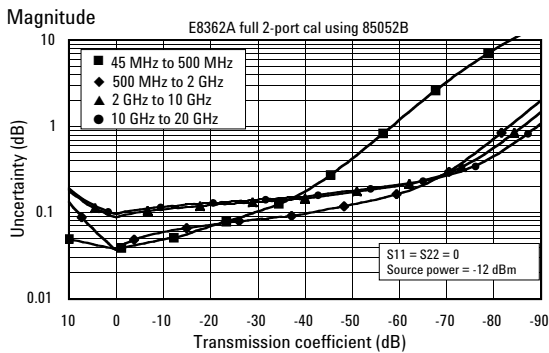

Reflection uncertainty (specifications)

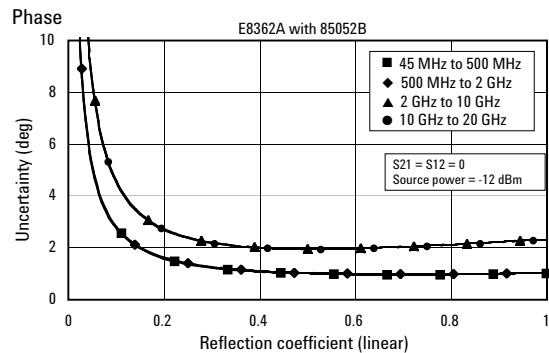
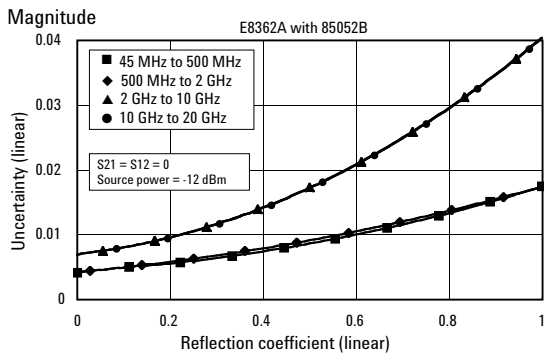

Extended configuration and standard power range (E8362A-Option 014)

Applies to E8362A PNA Series analyzer, 85052B (3.5 mm) calibration kit, 85131F flexible test port cable set, and a full two-port calibration. (Specifications apply over environmental temperature of $23^{\circ} \pm 3^{\circ}\text{C}$, with less than 1°C deviation from calibration temperature.)

Description	Specification (dB)			
	45 MHz to 500 MHz	500 MHz to 2 GHz	2 to 10 GHz	10 to 20 GHz
Directivity	48	48	44	44
Source match	40	40	31	31
Load match	48	48	44	44
Reflection tracking	$\pm(0.003 + 0.2/^{\circ}\text{C})$	$\pm(0.003 + 0.2/^{\circ}\text{C})$	$\pm(0.006 + 0.2/^{\circ}\text{C})$	$\pm(0.006 + 0.2/^{\circ}\text{C})$
Transmission tracking	$\pm(0.017 + 0.2/^{\circ}\text{C})$	$\pm(0.017 + 0.2/^{\circ}\text{C})$	$\pm(0.065 + 0.2/^{\circ}\text{C})$	$\pm(0.091 + 0.2/^{\circ}\text{C})$
Crosstalk (reflection port to transmission port: short circuits at both ports; isolation calibration applied)	< -85	< -100	< -110	< -100

Transmission uncertainty (specifications)

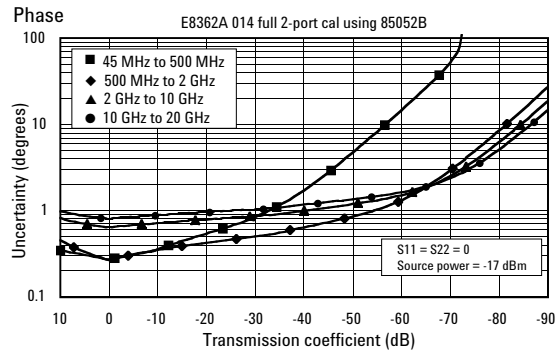
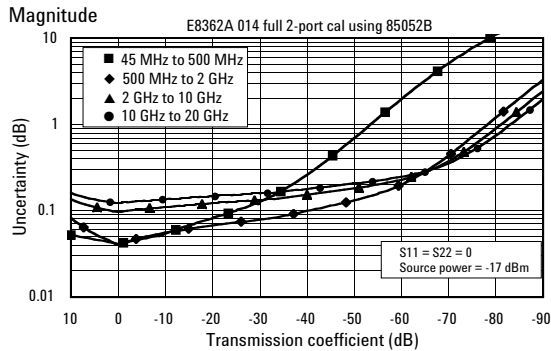

Reflection uncertainty (specifications)

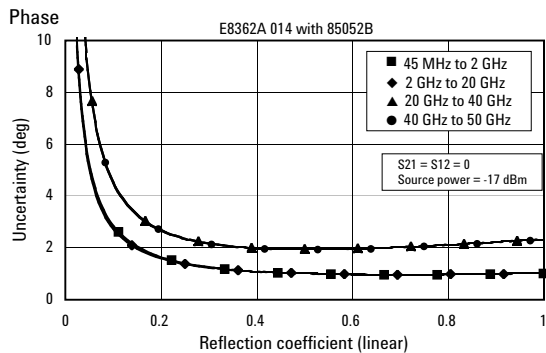
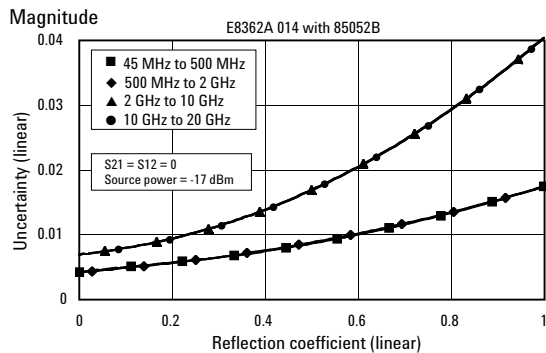

Corrected system performance with 3.5 mm connectors *continued*

Standard configuration and extended power range and bias-tees (E8362A-Option UNL)

Applies to E8362A PNA Series analyzer, 85052B (3.5 mm) calibration kit, 85131F flexible test port cable set, and a full two-port calibration. (Specifications apply over environmental temperature of $23^\circ \pm 3^\circ\text{C}$, with less than 1°C deviation from calibration temperature.)

Description	Specification (dB)			
	45 MHz to 500 MHz	500 MHz to 2 GHz	2 to 10 GHz	10 to 20 GHz
Directivity	48	48	44	44
Source match	40	40	31	31
Load match	48	48	44	44
Reflection tracking	$\pm(0.003 + 0.2/^\circ\text{C})$	$\pm(0.003 + 0.2/^\circ\text{C})$	$\pm(0.006 + 0.2/^\circ\text{C})$	$\pm(0.006 + 0.2/^\circ\text{C})$
Transmission tracking	$\pm(0.017 + 0.2/^\circ\text{C})$	$\pm(0.017 + 0.2/^\circ\text{C})$	$\pm(0.065 + 0.2/^\circ\text{C})$	$\pm(0.091 + 0.2/^\circ\text{C})$
Crosstalk (reflection port to transmission port: short circuits at both ports; isolation calibration applied)	< -85	< -100	< -110	< -100

Transmission uncertainty (specifications)

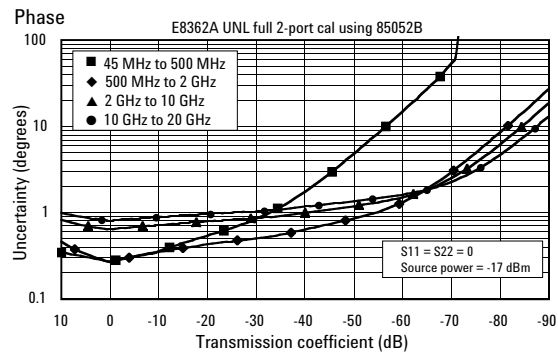
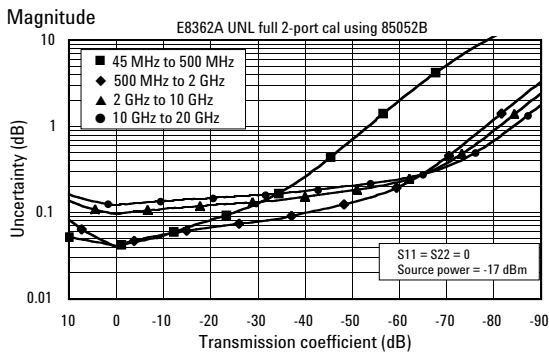

Reflection uncertainty (specifications)

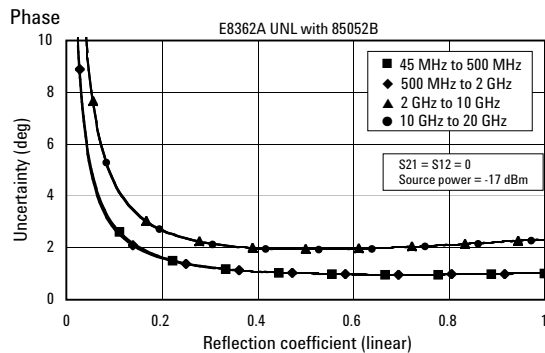
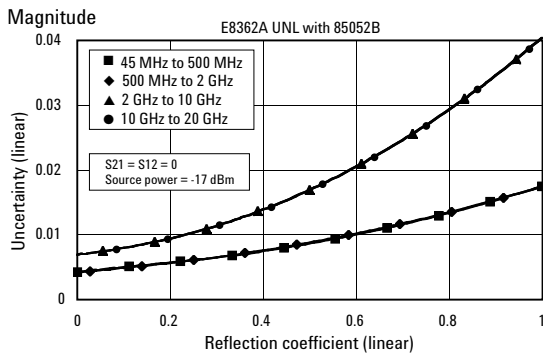

Extended configuration and extended power range and bias-tees (E8362A-Options UNL and 014)

Applies to E8362A PNA Series analyzer, 85052B (3.5 mm) calibration kit, 85131F flexible test port cable set, and a full two-port calibration. (Specifications apply over environmental temperature of $23^\circ \pm 3^\circ\text{C}$, with less than 1°C deviation from calibration temperature.)

Description	Specification (dB)			
	45 MHz to 500 MHz	500 MHz to 2 GHz	2 to 10 GHz	10 to 20 GHz
Directivity	48	48	44	44
Source match	40	40	31	31
Load match	48	48	44	44
Reflection tracking	$\pm(0.003 + 0.2/^\circ\text{C})$	$\pm(0.003 + 0.2/^\circ\text{C})$	$\pm(0.006 + 0.2/^\circ\text{C})$	$\pm(0.006 + 0.2/^\circ\text{C})$
Transmission tracking	$\pm(0.017 + 0.2/^\circ\text{C})$	$\pm(0.017 + 0.2/^\circ\text{C})$	$\pm(0.065 + 0.2/^\circ\text{C})$	$\pm(0.091 + 0.2/^\circ\text{C})$
Crosstalk (reflection port to transmission port: short circuits at both ports; isolation calibration applied)	< -85	< -100	< -110	< -100

Transmission uncertainty (specifications)

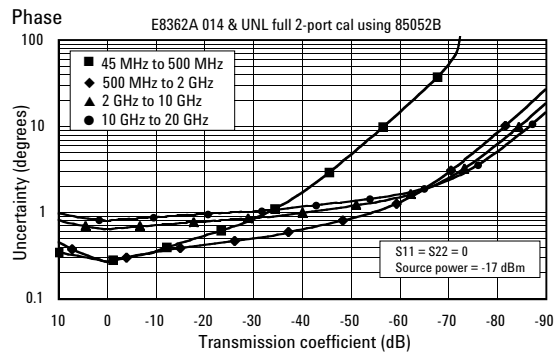
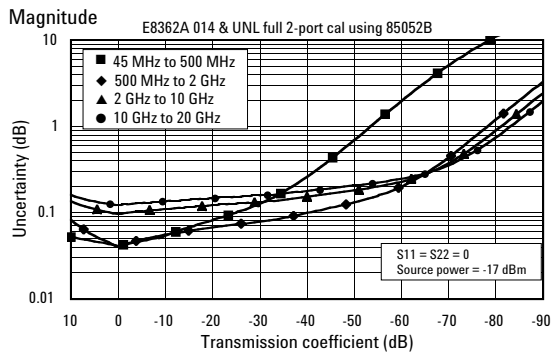

Reflection uncertainty (specifications)

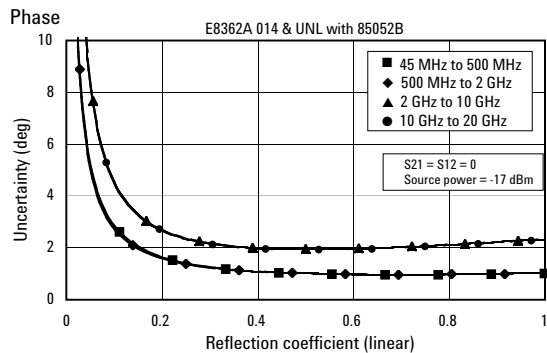
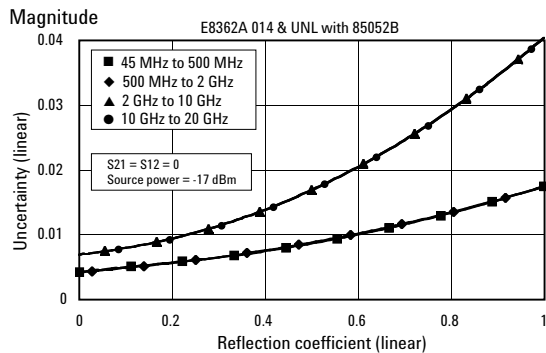

Uncorrected system performance¹

Description	Specification	Supplemental information
Directivity		
45 MHz to 2 GHz	24 dB	Typical: 29 dB
2 to 10 GHz	22 dB	25 dB
10 to 20 GHz	16 dB	20 dB
20 to 40 GHz	16 dB	20 dB
40 to 45 GHz	15 dB	18 dB
45 to 50 GHz	13 dB	18 dB
Source match - standard		
45 MHz to 2 GHz	23 dB	Typical: 27 dB
2 to 10 GHz	16 dB	19 dB
10 to 20 GHz	14 dB	19 dB
20 to 40 GHz	10 dB	14 dB
40 to 45 GHz	9 dB	13.5 dB
45 to 50 GHz	5.5 dB	9 dB
Source match - Option UNL, 014, or UNL and 014		
45 MHz to 2 GHz	18 dB	Typical: 22.5 dB
2 to 10 GHz	14 dB	18 dB
10 to 20 GHz	12 dB	15 dB
20 to 40 GHz	8 dB	10 dB
40 to 45 GHz	7 dB	10 dB
45 to 50 GHz	4 dB	6.5 dB
Load match - standard		
45 MHz to 2 GHz	23 dB	Typical: 29 dB
2 to 10 GHz	14 dB	16 dB
10 to 20 GHz	10 dB	12 dB
20 GHz to 40 GHz	9 dB	12 dB
40 to 45 GHz	9 dB	13 dB
45 to 50 GHz	7 dB	10 dB
Load match - Option UNL, 014, or UNL and 014		
45 MHz to 2 GHz	17 dB	Typical: 21.5 dB
2 to 10 GHz	13 dB	16.5 dB
10 to 20 GHz	10 dB	13 dB
20 to 40 GHz	9 dB	11 dB
40 to 45 GHz	8 dB	11 dB
45 to 50 GHz	6 dB	8 dB
Reflection tracking		
45 MHz to 20 GHz		Typical: ±1.5 dB
20 to 40 GHz		±1.5 dB
40 to 50 GHz		±2.0 dB
Transmission tracking²		
45 MHz to 2 GHz		Typical: ±1.5 dB
2 to 10 GHz		±2.0 dB
10 to 20 GHz		±2.5 dB
20 to 40 GHz		±3.5 dB
40 to 45 GHz		±4.0 dB
45 to 50 GHz		±4.5 dB

1. Specifications apply over environment temperature of 23°C, with less than 1°C deviation from the calibration temperature.

2. Transmission tracking performance is strongly dependent on cable used; These typical specifications are set based on the use of Agilent thru cable part number 85133-60016.

Description	Specification	Supplemental information
Crosstalk¹ - standard		
45 MHz to 1 GHz	85 dB	
1 to 2 GHz	100 dB	
2 to 20 GHz	110 dB	
20 to 40 GHz	108 dB	
40 to 45 GHz	105 dB	
45 to 50 GHz	100 dB	
Crosstalk¹ - Option UNL or 014		
45 MHz to 1 GHz	85 dB	
1 to 2 GHz	100 dB	
2 to 20 GHz	109 dB	
20 to 40 GHz	106 dB	
40 to 45 GHz	103 dB	
45 to 50 GHz	98 dB	
Crosstalk¹ - Option UNL and 014		
45 MHz to 1 GHz	85 dB	
1 to 2 GHz	98 dB	
2 to 10 GHz	108 dB	
10 to 20 GHz	107 dB	
20 to 40 GHz	104 dB	
40 to 45 GHz	100 dB	
45 to 50 GHz	95 dB	

1. Measurement conditions: Normalized to a thru, measured with two shorts, 10-Hz IF bandwidth, averaging factor of 8, alternate mode, source power set to the lesser of the maximum power out or the maximum receiver power.

Test port output¹

Description	Specification				Supplemental information
	Standard	014	UNL	UNL and 014	
Frequency range					
E8362A	45 MHz to 20 GHz				
E8363A	45 MHz to 40 GHz				
E8364A	45 MHz to 50 GHz				
Nominal power	-12 dBm	-17 dBm	-17 dBm	-17 dBm	
Frequency resolution	1 Hz	1 Hz	1 Hz	1 Hz	
CW accuracy	± 1ppm	± 1ppm	± 1ppm	± 1ppm	
Frequency stability					±1 ppm 0 to 40°C, typical ±0.2 ppm/yr, typical
Power level accuracy					
45 MHz to 10 GHz	±1.5 dB	±1.5 dB	±1.5 dB	±1.5 dB	Variation from nominal power in range 0 (step attenuator at 0 dB).
10 to 20 GHz	±2.0 dB	±2.0 dB	±2.0 dB	±2.0 dB	
20 to 40 GHz	±3.0 dB	±3.0 dB	±3.0 dB	±3.0 dB	
40 to 45 GHz	±3.0 dB	±3.5 dB	±3.0 dB	±3.5 dB	
45 to 50 GHz	±3.0 dB	±4.0 dB	±3.0 dB	±4.0 dB	
Power level linearity					
45 MHz to 20 GHz	±1.0 dB	±1.0 dB	±1.0 dB ²	±1.0 dB ²	Test reference is at the nominal power level (step attenuator at 0 dB).
20 to 40 GHz	±1.0 dB	±1.0 dB	±1.0 dB ²	±1.0 dB ²	
40 to 50 GHz	±1.0 dB	±1.0 dB	±1.0 dB	±1.0 dB	
Power range³					
45 MHz to 10 GHz	-25 to +5 dB	-25 to +5 dBm	-87 to +3 dBm	-87 to +3 dBm	
10 to 20 GHz	-24 to +3 dB	-25 to +2 dBm	-86 to +1 dBm	-87 to 0 dBm	
20 to 30 GHz	-23 to 0 dBm	-25 to -2 dBm	-85 to -2 dBm	-87 to -4 dBm	
30 to 40 GHz	-23 to -4 dBm	-25 to -6 dBm	-85 to -6 dBm	-87 to -8 dBm	
40 to 45 GHz	-25 to -5 dBm	-27 to -7 dBm	-87 to -9 dBm	-87 to -11 dBm	
45 to 50 GHz	-25 to -10 dBm	-27 to -12 dBm	-87 to -15 dBm	-87 to -17 dBm	
Power sweep range (ALC)					
45 MHz to 10 GHz	30 dB	30 dB	30 dB	30 dB	ALC range starts at maximum leveled output power and goes down to power level indicated by dB amount specified.
10 to 20 GHz	27 dB	27 dB	27 dB	27 dB	
20 to 30 GHz	23 dB	23 dB	23 dB	23 dB	
30 to 40 GHz	19 dB	19 dB	19 dB	19 dB	
40 to 45 GHz	20 dB	20 dB	18 dB	16 dB	
45 to 50 GHz	15 dB	15 dB	12 dB	10 dB	
Power resolution	0.01 dB	0.01 dB	0.01 dB	0.01 dB	
Phase noise (10-kHz offset from center frequency, nominal power at test port)					
45 MHz to 10 GHz					-70 dBc typical
10 to 20 GHz					-65 dBc typical
20 to 40 GHz					-55 dBc typical
40 to 50 GHz					-55 dBc typical
Harmonics (2nd or 3rd)					
					-23 dBc typical, in power
Non-harmonic spurious (at nominal output power)					
45 MHz to 20 GHz					-50 dBc typical, for offset frequency > 1 kHz
20 to 40 GHz					-30 dBc typical, for offset frequency > 1 kHz
40 to 50 GHz					-30 dBc typical, for offset frequency > 1 kHz

1. Source output performance on port 1 only. Port 2 output performance is a characteristic.
2. ±1.5 dB for power ≤ -23 dBm.
3. Power to which the source can be set and phase lock is assured.

Test port input

Description	Specification				Supplemental information
	Standard	014	UNL	UNL and 014	
Test port noise floor¹					
10-Hz IF bandwidth					
45 to 500 MHz ²	< -89 dBm	< -89 dBm	< -89 dBm	< -89 dBm	
500 MHz to 2 GHz	< -114 dBm	< -114 dBm	< -114 dBm	< -114 dBm	
2 to 10 GHz	< -117 dBm	< -117 dBm	< -117 dBm	< -117 dBm	
10 to 20 GHz	< -120 dBm	< -119 dBm	< -120 dBm	< -119 dBm	
20 to 40 GHz	< -114 dBm	< -113 dBm	< -114 dBm	< -113 dBm	
40 to 50 GHz	< -114 dBm	< -112 dBm	< -114 dBm	< -112 dBm	
1-Hz IF bandwidth					
45 to 500 MHz ²	< -69 dBm	< -69 dBm	< -69 dBm	< -69 dBm	
500 MHz to 2 GHz	< -94 dBm	< -94 dBm	< -94 dBm	< -94 dBm	
2 to 10 GHz	< -97 dBm	< -97 dBm	< -97 dBm	< -97 dBm	
10 to 20 GHz	< -100 dBm	< -99 dBm	< -100 dBm	< -99 dBm	
20 to 40 GHz	< -94 dBm	< -93 dBm	< -94 dBm	< -93 dBm	
40 to 50 GHz	< -94 dBm	< -92 dBm	< -94 dBm	< -92 dBm	
Direct receiver access input noise floor¹					
10-Hz IF bandwidth					
45 to 500 MHz ²		< -127 dBm		< -127 dBm	
500 MHz to 2 GHz		< -133 dBm		< -133 dBm	
2 to 10 GHz		< -132 dBm		< -132 dBm	
10 to 20 GHz		< -134 dBm		< -134 dBm	
20 to 40 GHz		< -125 dBm		< -125 dBm	
40 to 50 GHz		< -123 dBm		< -123 dBm	
1-Hz IF bandwidth					
45 to 500 MHz		< -107 dBm		< -107 dBm	
500 MHz to 2 GHz		< -113 dBm		< -113 dBm	
2 to 10 GHz		< -112 dBm		< -112 dBm	
10 to 20 GHz		< -114 dBm		< -114 dBm	
20 to 40 GHz		< -105 dBm		< -105 dBm	
40 to 50 GHz		< -103 dBm		< -103 dBm	
Receiver compression level					
45 MHz to 20 GHz	—————	< 0.6 dB compression at +5 dBm	—————		
20 to 30 GHz	—————	< 0.6 dB compression at 0 dBm	—————		
30 to 40 GHz	—————	< 0.6 dB compression at -3 dBm	—————		
40 to 50 GHz	—————	< 0.6 dB compression at -3 dBm	—————		
System compression level		max output power			See dynamic accuracy chart
Trace noise magnitude					
45 to 500 MHz	—————	< 0.010 dB rms	—————		1-kHz IF bandwidth Ratio measurement, nominal power at test port
500 MHz to 20 GHz	—————	< 0.006 dB rms	—————		
20 to 40 GHz	—————	< 0.006 dB rms	—————		
40 to 50 GHz	—————	< 0.006 dB rms	—————		
Trace noise phase					
45 to 500 MHz ³	—————	< 0.100° rms	—————		1-kHz IF bandwidth Ratio measurement, nominal power at test port
500 MHz to 20 GHz	—————	< 0.060° rms	—————		
20 to 40 GHz	—————	< 0.100° rms	—————		
40 to 50 GHz	—————	< 0.100° rms	—————		

1. Total average (rms) noise power calculated as mean value of a linear magnitude trace expressed in dBm.
2. Noise floor may be degraded by 10 dB at particular frequencies (multiples of 5 MHz) due to spurious receiver residuals.
3. Trace noise magnitude may be degraded to 20 mdB rms at harmonic frequencies of the first IF (8.33 MHz) below 80 MHz.

Test port input *continued*

Description	Specification				Supplemental information
	Standard	014	UNL	UNL and 014	
Reference level magnitude					
Range	±200 dB	±200 dB	±200 dB	±200 dB	
Resolution	0.001 dB	0.001 dB	0.001 dB	0.001 dB	
Reference level phase					
Range	±500°	±500°	±500°	±500°	
Resolution	0.01°	0.01°	0.01°	0.01°	
Stability magnitude¹					
45 MHz to 20 GHz					Typical ratio measurement: Measured at the test port ±0.02 dB/°C ±0.03 dB/°C ±0.04 dB/°C
20 to 40 GHz					
40 to 50 GHz					
Stability phase¹					
45 MHz to 20 GHz					Typical ratio measurement: Measured at the test port ±0.2°/°C ±0.5°/°C ±0.8°/°C
20 to 40 GHz					
40 to 50 GHz					
Damage input level					
Test port 1 and 2					20 dBm or ±40 VDC, typical
R1, R2 in					15 dBm or ±15 VDC, typical
A, B in					15 dBm or ±15 VDC, typical
Coupler thru (option 014 or UNL and 014)					30 dBm or ±40 VDC, typical
Coupler arm (option 014 or UNL and 014)					30 dBm or ±7 VDC, typical

1. Stability is defined as a ratio measurement measured at the test port.

Group delay¹

Description	Specification	Supplemental information
Aperture (selectable)	(frequency span)/(number of points – 1)	
Maximum aperture	20% of frequency span	
Range	0.5 x (1/minimum aperture)	
Maximum delay		Limited to measuring no more than 180° of phase change within the minimum aperture.

The following graph shows characteristic group delay accuracy with type-N full 2-port calibration and a 10-Hz IF bandwidth. Insertion loss is assumed to be less than 2 dB and electrical length to be 10 m.

Group delay (typical)

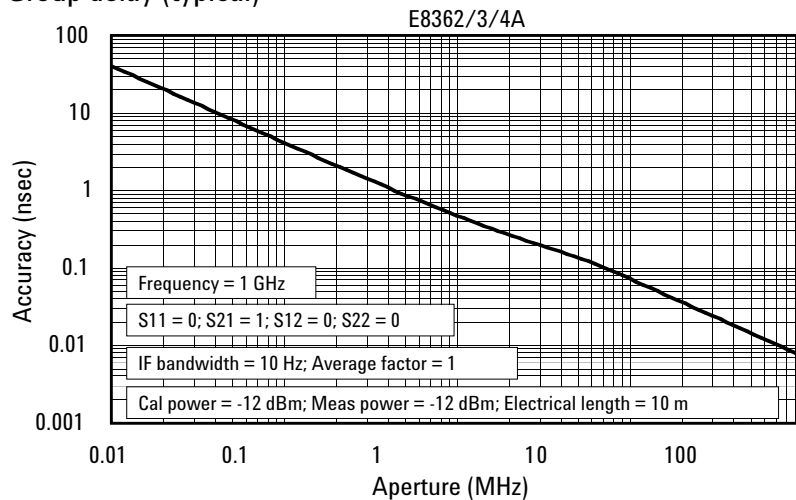

In general, the following formula can be used to determine the accuracy, in seconds, of a specific group delay measurement:

$$\pm \text{Phase accuracy (deg)} / [360 \times \text{Aperture (Hz)}]$$

Depending on the aperture and device length, the phase accuracy used is either incremental phase accuracy or worse case phase accuracy.

1. Group delay is computed by measuring the phase change within a specified frequency step (determined by the frequency span and the number of points per sweep).

Test port input *continued*

Dynamic accuracy

Applies to input ports 1 and 2, accuracy of the test port input power reading relative to the reference input power level. Also applies to the following conditions:

- IF bandwidth = 10 Hz
- test port powers = > -50 dBm and < 0 dBm
- magnitude dynamic accuracy = 0.02 dB + 0.001 dB/dB from reference power
- phase dynamic accuracy = $0.132^\circ = 0.0066^\circ/\text{dB}$ from reference power

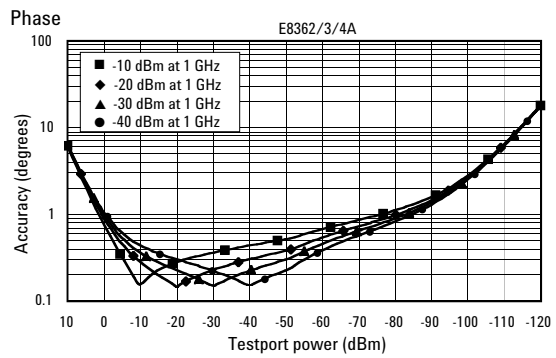
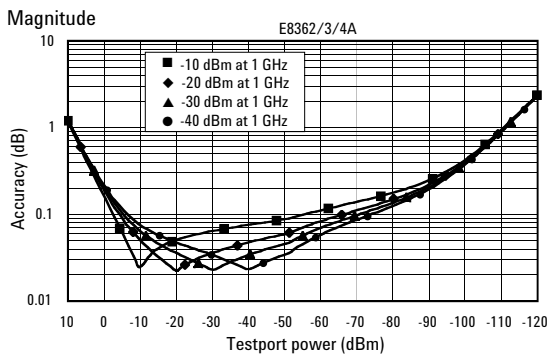

General information

Description	Supplemental information
System IF bandwidth range	1 Hz to 40 kHz, nominal
RF connectors	
E8362A	3.5 mm (male), 50 Ω , (nominal), center pin recession flush to .002 in. (characteristic)
E8363/4A	2.4 mm (male), 50 Ω , (nominal), center pin recession flush to .002 in. (characteristic)
Display	8.4 in diagonal color active matrix LCD; 640 (horizontal) x 480 (vertical) resolution; 59.83 Hz vertical refresh rate; 31.41 Hz horizontal refresh rate
Display range	
Magnitude	± 200 dB (at 20 dB/div), max
Phase	$\pm 180^\circ$, max
Polar	10 pico units, min; 1000 units, max
Display resolution	
Magnitude	0.001 dB/div, min
Phase	0.01 $^\circ$ /div, min
Marker resolution	
Magnitude	0.001 dB, min
Phase	0.01 $^\circ$, min
Polar	0.01 mUnit, min; 0.01 $^\circ$, min
CPU	Intel [®] 500 MHz Pentium [®] III
Rear panel	
10-MHz reference in	
Input frequency	10 MHz ± 10 ppm, typ.
Input power	-15 dBm to +20 dBm, typ.
Input impedance	200 Ω , nom.
10-MHz reference out	
Output frequency	10 MHz ± 10 ppm, typ.
Signal type	Sine wave, typ.
Output power	10 dB ± 4 dB into 50 Ω , typ.
Output impedance	50 Ω , nom.
Harmonics	< -40 dBc, typ.
VGA video output	15-pin mini D-Sub; Drives VGA compatible monitors
GPIB	Type D-24, 24-pin; female compatible with IEEE-488
Parallel port (LPT1)	25-pin D-sub miniature connector; provides connection to printers or any other parallel port peripheral
Serial port (COM1)	9-pin D-Sub; male compatible with RS-232
USB port	Type-A configuration (4 contacts inline, contact 1 on left); female
Contact 1	Vcc: 4.75 to 5.25 VDC, 500 mA max
Contact 2	-Data
Contact 3	+Data
Contact 4	Ground
LAN	10/100 BaseT Ethernet; 8-pin configuration
Test set I/O	25-pin D-sub; available for external test set control
Handler I/O	36-pin, parallel I/O port; all input/output signals are default set to negative logic; can be rest to positive logic via GPIB command
Auxiliary I/O	25-pin connector; analog and digital I/O

General information *continued*

Description	Supplemental information
Line power¹	
Frequency	48 Hz to 66 Hz
Voltage at 115-V setting	90 to 132 VAC; 120 VAC, nom.
Voltage at 220-V setting	198 to 264 VAC; 240 VAC, nom.
VA max	600 VA max
General environmental	
RFI/EMI susceptibility	Defined by CISPR Pub. 11, Group 1, Class A, and IEC 50082-1
ESD	Minimize using static-safe work procedures and an antistatic bench mat
Dust	Minimize for optimum reliability
Operating environment	
Temperature	0°C to +40°C; Instrument powers up, phase locks, and displays no error messages within this temperature range. (Except for 'source unlevelled' error message that may occur at temperature extremes when power approaches limits of ALC range.)
Error-corrected temperature range	System specifications valid from 25°C ±5°C, with less than 1°C deviation from the calibration temperature
Humidity	5 to 95% at +40°C
Altitude	0 to 4500 m (14,760 ft)
Non-operating storage environment	
Temperature	-40°C to +70°C
Humidity	0 to 90% at +65°C (non-condensing)
Altitude	0 to 15,240 m (50,000 ft)
Cabinet dimensions	
Height x width x depth	Exclude front and rear protrusions 267 x 425 x 426 mm, nom. (10.5 x 16.75 x 16.8 in, nom.)
Weight	
Net	29 kg (64 lb), nom.
Shipping	36 kg (80 lb), nom.

1. A third-wire ground is required.

Measurement throughput summary

Cycle time vs. IF bandwidth¹

Instrument state: preset condition, 201 points, CF = 1 GHz, Span = 100 MHz, correction off. Add 21 ms for display on. Cycle time includes sweep and re-trace time.

IF bandwidth (Hz)	Cycle time (ms)
40,000	8
35,000	9
30,000	11
20,000	13
10,000	28
7,000	36
5,000	48
3,000	72
1,000	196
300	620
100	3853
30	8041
10	19855

Cycle time vs. number of points¹

Instrument state: preset condition, 35 kHz IF bandwidth, CF = 1 GHz, Span = 100 MHz, correction off. Add 21 ms for display on. Cycle time includes sweep and re-trace time.

Number of points	Cycle time (ms)
3	4
11	4
51	5
101	6
201	9
401	16
801	29
1601	55

Cycle time^{1,2} (ms)

	Number of points			
	51	201	401	1601
Start (fundamental band), IFBW = 35 kHz				
Uncorrected and one-port cal	21	23	28	65
Two-port cal	52	57	70	152
Start 45 MHz kHz, stop 10 GHz, IFBW = 35 kHz				
Uncorrected and one-port cal	71	79	84	110
Two-port cal	153	171	182	243
Start 45 MHz, stop 20 GHz, IFBW = 35 kHz				
Uncorrected and one-port cal	103	116	121	139
Two-port cal	216	245	256	303
Start 45 MHz, stop 40 GHz, IFBW = 35 kHz				
Uncorrected and one-port cal	145	181	190	232
Two-port cal	293	367	382	428
Start 45 MHz, stop 50 GHz, IFBW = 35 kHz				
Uncorrected and one-port cal	163	210	218	256
Two-port cal	332	425	442	487
Time Domain³ (increase over uncorrected sweep time)				
Conversions	<1	<1	4	13
Gating	<1	<1	4	17

1. Typical performance.
2. Includes sweep time, retrace time and band-crossing time. Analyzer display turned off with DISPLAY:ENABLE OFF. Add 21 ms for display on. Data for one trace (S11) measurement.
3. Option 010 only. Analyzer display turned off with DISPLAY:ENABLE OFF. Add 21 ms for display on.

Data transfer time (ms)¹

	Number of points			
	51	201	401	1601
SCPI over GPIB				
(program executed on external PC)				
32-bit floating point	3	7	12	43
64-bit floating point	4	12	22	84
ASCII	18	64	124	489
SCPI over 100 Mbit/s LAN				
(program executed on external PC)				
32-bit floating point	1	1	1	1
64-bit floating point	1	1	1	2
ASCII	5	15	26	96
SCPI (program executed in the analyzer)				
32-bit floating point	1	1	2	3
64-bit floating point	1	2	2	4
ASCII	8	29	56	222
COM (program executed in the analyzer)				
32-bit floating point	1	1	1	1
Variant type	1	1	2	6
DCOM over LAN				
(program executed on external PC)				
32-bit floating point	1	1	1	2
Variant type	1	3	6	19

1. Typical performance.

PNA Series simplified test set block diagram

Standard power range

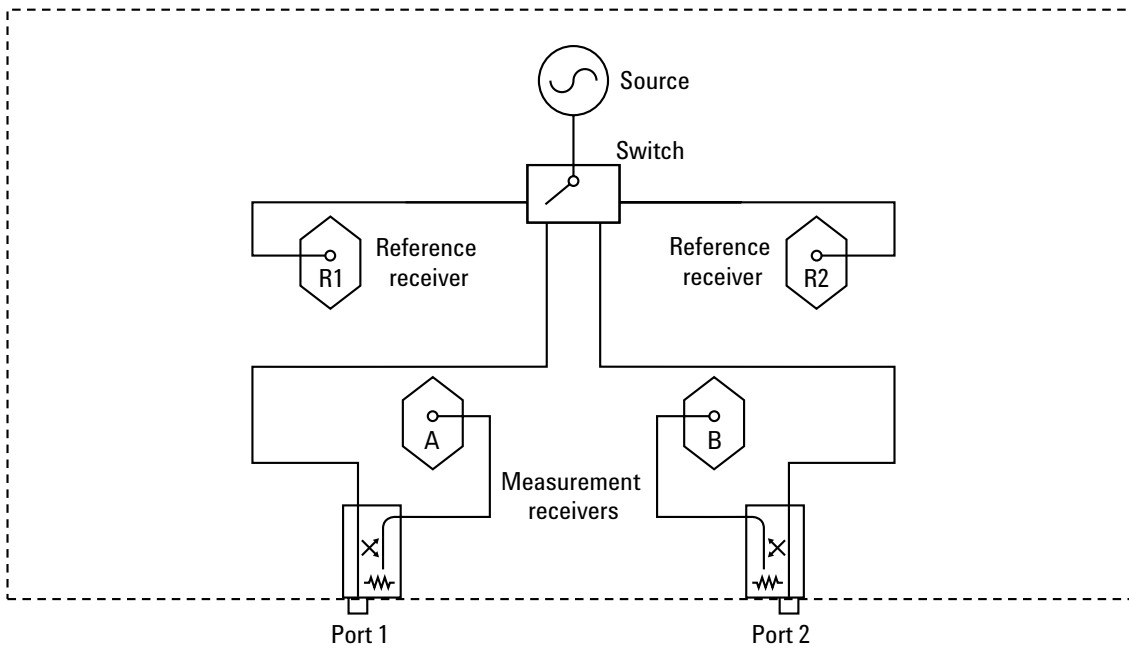

Extended configuration, source access, receiver (Option 014)

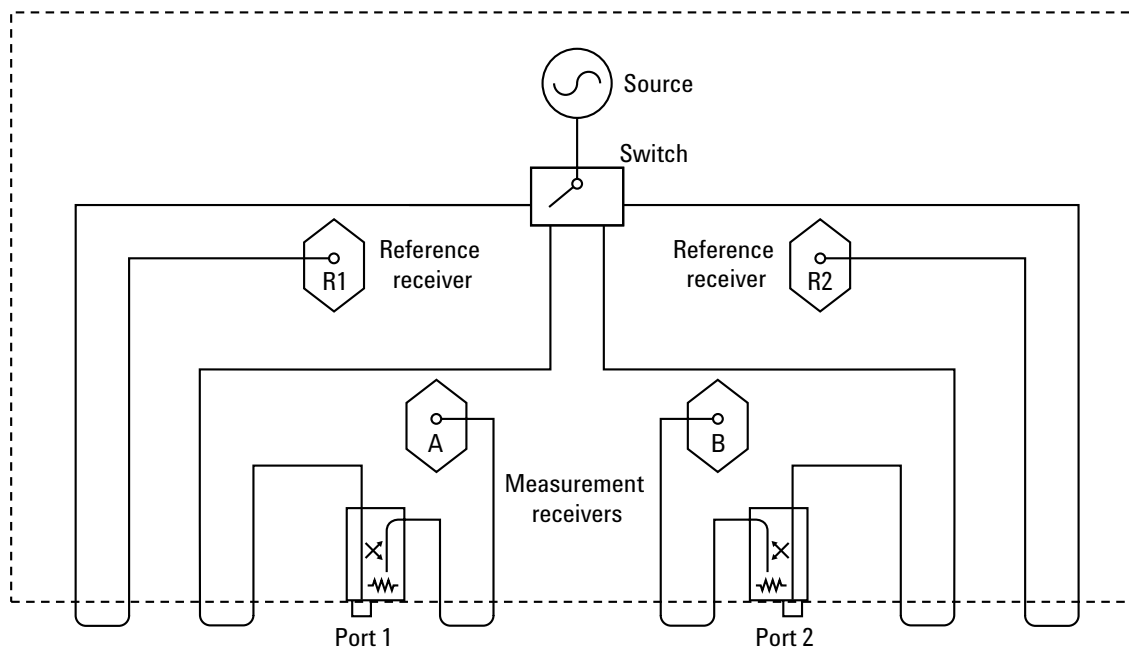

Extended power range and bias-tees (Option UNL)

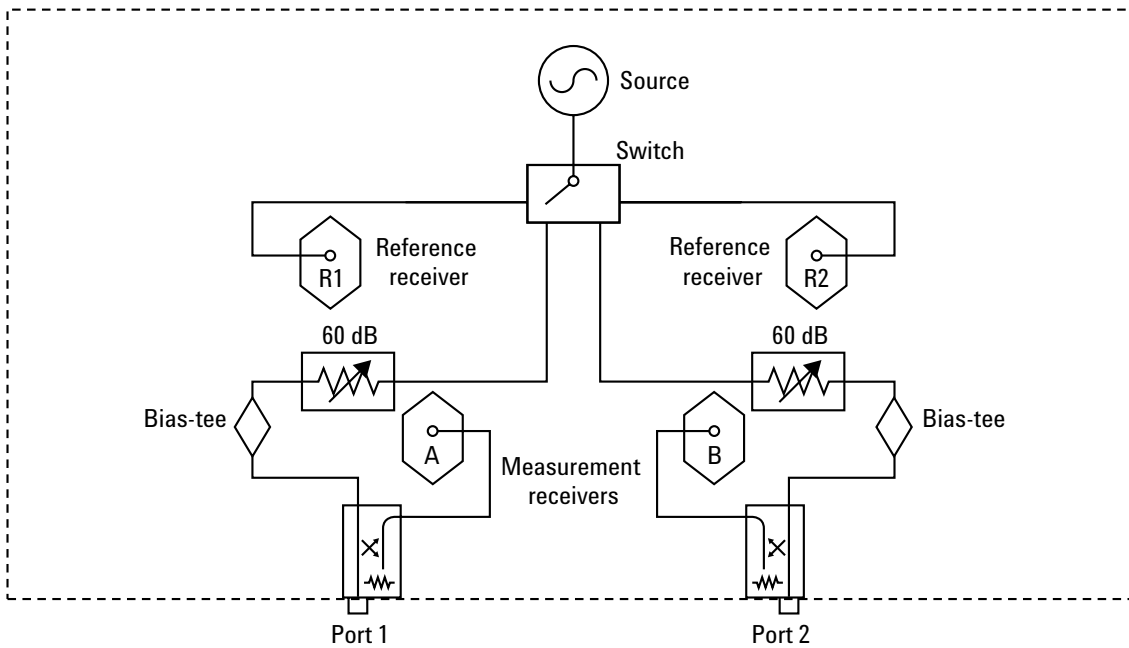

Extended configuration with extended power range and bias-tees (Option UNL and 014)

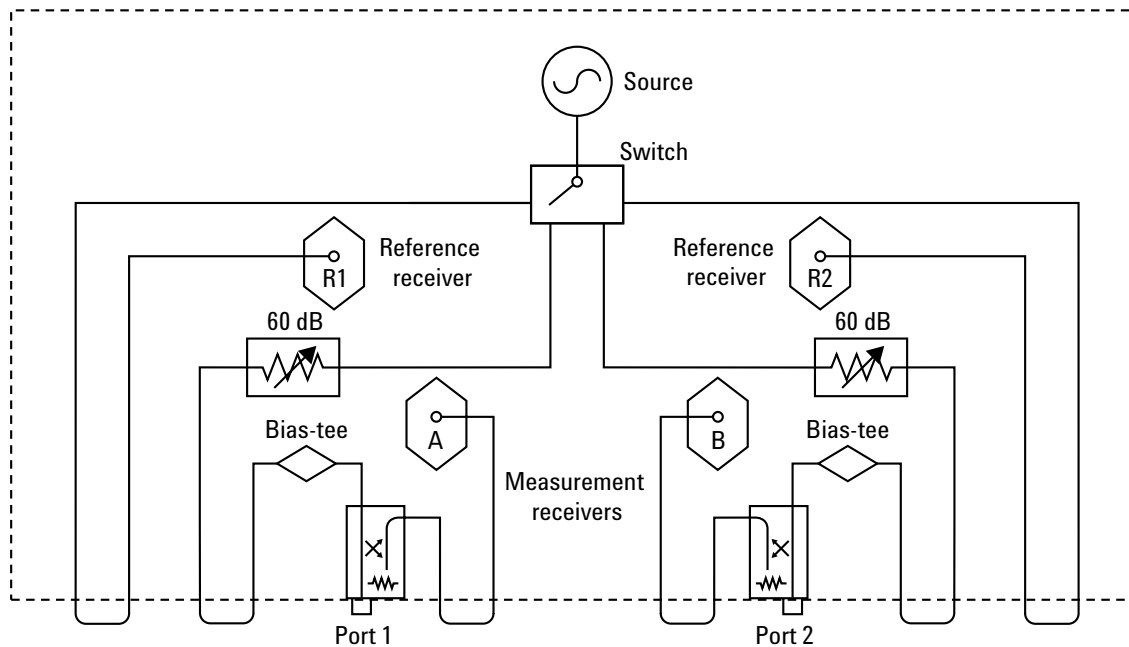

Measurement capabilities

Number of measurement channels

Sixteen independent measurement channels. A measurement channel is coupled to stimulus settings including frequency, IF bandwidth, power level, and number of points.

Number of display windows

Up to four display windows. Each window can be sized and re-arranged. Up to four measurement channels can be displayed per window.

Number of traces

Up to four active traces and four memory traces per window. Sixteen total active traces and 16 memory traces can be displayed. Measurement traces include S-parameters, as well as relative and absolute power measurements.

Measurement choices

S11, S21, S12, S22, A/R1, A/R2, A/B, B/R1, B/R2, B/A, R1/A, R1/B, R1/R2, R2/A, R2/B, R2/R1, A, B, R1, R2

Formats

Log or linear magnitude, SWR, phase, group delay, real and imaginary, Smith chart, polar.

Data markers

Ten independent markers per trace. Reference marker available for delta marker operation. Marker formats include log or linear magnitude, phase, real, imaginary, SWR, delay, $R + jX$, and $G + jB$.

Marker functions

Marker search

Maximum value, minimum value, target, next peak, peak right, peak left, target, and bandwidth with user-defined target values

Marker-to functions

Set start, stop, and center to active marker stimulus value; set reference to active marker response value; set electrical delay to active marker phase response value.

Trace statistics

Calculates and displays mean, standard deviation and peak-to-peak deviation of the data trace.

Tracking

Performs new search continuously or on demand.

Source control

Measured number of points per sweep

User definable from 2 to 1601.

Sweep type

Linear, CW (single frequency), power or segment sweep.

Segment sweep

Define up to 101 different, sub-sweep frequency ranges in any combination of start-stop sweep modes. Set number of points, test port power levels, IF bandwidth, and dwell time independently for each segment.

Sweep trigger

Set to continuous, hold, single, or group sweep with internal or external trigger.

Power

Power slope can be set in dBm/GHz. Control the test port signal by setting the internal attenuator of the test set over a 60-dB range.

Trace functions

Display data

Display current measurement data, memory data, or current measurement with measurement and memory data simultaneously.

Trace math

Vector addition, subtraction, multiplication or division of current linear measurement values and memory data.

Display annotations

Start/stop, center/span, or CW frequency, scale/div, reference level, marker data, warning and caution messages, trace status, and pass/fail indication.

Title

Add custom titles (50 characters maximum) to the display. Titles will be printed when making hardcopies of displayed measurements.

Autoscale

Automatically selects scale resolution and reference value to center the trace.

Electrical delay

Offset measured phase or group delay by a defined amount of electrical delay, in seconds.

Phase offset

Offset measured phase or group delay by a defined amount in degrees.

Data accuracy enhancement

Measurement calibration

Measurement calibration significantly reduces measurement uncertainty due to errors caused by system directivity, source and load match, tracking and crosstalk. Full two-port calibration removes all the systematic errors to obtain the most accurate measurements.

Calibration types available

Frequency response

Simultaneous magnitude and phase correction of frequency response errors for either reflection or transmission measurements.

Response and isolation

Compensates for frequency response and directivity (reflection) or frequency response and crosstalk errors.

One-port calibration

Uses test set port 1 or port 2 to correct for directivity, frequency response and source match errors.

Two-port calibration

Compensates for directivity, source match, reflection frequency response, load match, transmission frequency response and crosstalk. Crosstalk calibration can be omitted.

TRL/TRM calibration

Compensates for directivity, reflection and transmission frequency response and crosstalk in both forward and reverse directions. Provides the highest accuracy for both coaxial and non-coaxial environments, such as on-wafer probing, in-fixture or waveguide measurements.

Interpolated error correction

With any type of accuracy enhancement applied, interpolated mode recalculates the error coefficients when the test frequencies are changed. The number of points can be increased or decreased and the start/stop frequencies can be changed, but the resulting frequency range must be within the original calibration frequency. System performance is not specified for measurements with interpolated error correction applied.

Velocity factor

Enters the velocity factor to calculate the equivalent electrical length.

Reference plane extension

Redefine the plane-of-measurement reference to other than port 1 or port 2.

Storage

Internal hard disk drive

Store and recall binary instrument states and calibration data on 10-GB, minimum, internal hard drive. Instrument data can also be saved in ASCII (including S2P) format. All files are MS-DOS®-compatible. Instrument states include all control settings, active limit lines, active list frequency tables, memory trace data.

Disk drive

Instrument data, instrument states, and calibration data can be stored on internal 3.5-in, 1.4-MB floppy disk in MS-DOS-compatible format.

Data hardcopy

Printouts of instrument data are directly produced on any printer with the appropriate Windows® 2000 printer driver. The analyzer provides USB, Centronics (parallel), serial and LAN interfaces.

System capabilities

Familiar graphical user interface

The PNA employs a graphical user interface based on Windows 2000. There are two fundamental ways to operate the instrument manually: you can use a hardkey interface, or use drop-down menus driven from a mouse (or another standard USB pointing device). Hardkey navigation brings up active toolbars that perform most of the operations required to configure and view measurements. Front-panel navigation keys allow for use of the instrument without a mouse. In addition, mouse-driven pull-down menus provide easy access to both standard and advanced features. Both methods employ dialog boxes to display all the choices needed to make measurement set-ups.

Built-in information system

Embedded documentation provides measurement assistance in five different languages (English, French, German, Japanese, and Spanish). A thorough index of help topics and context-sensitive help available from dialog boxes.

Limit lines

Define test limit lines that appear on the display for go/no go testing. Lines may be any combination of horizontal, sloping lines, or discrete data points.

Time-domain (Option 010)

With the time-domain option, data from transmission or reflection measurements in the frequency domain are converted to the time domain using a Fourier transformation technique (chirp Z) and presented on the display. The time-domain response shows the measured parameter value versus time. Markers may also be displayed in electrical length (or physical length if the relative propagation velocity is entered).

Time stimulus modes

Two types of time excitation stimulus waveforms can be simulated during the transformations, a step and an impulse.

Low-pass step

This stimulus, similar to a traditional time-domain reflectometer (TDR) stimulus waveform, is used to measure low-pass devices. The frequency-domain data should extend from DC (extrapolated value) to a higher value. The step response is typically used for reflection measurements only.

Low-pass impulse

This stimulus is also used to measure low-pass devices. The impulse response can be used for reflection or transmission measurements.

Bandpass impulse

The bandpass impulse stimulates a pulsed RF signal (with an impulse envelope) and is used to measure the time-domain response of band-limited devices. The start and stop frequencies are selectable by the user to any values within the limits of the test set used. Bandpass time-domain responses are useful for both reflection and transmission measurements.

Time-domain range

The "alias-free" range over which the display is free of response repetition depends on the frequency span and the number of points. Range, in nanoseconds, is determined by: $\text{Time-domain range} = (\text{number of points} - 1) / \text{frequency span [in GHz]}$

Range resolution

The time resolution of a time-domain response is related to range as follows: $\text{Range resolution} = \text{time span} / (\text{number of points} - 1)$

Windows

The windowing function can be used to modify (filter) the frequency-domain data and thereby reduce over-shoot and ringing in the time-domain response. Kaiser Beta windows are available.

Gating

The gating function can be used to selectively remove reflection or transmission time-domain responses. In converting back to the frequency-domain the effects of the responses outside the gate are removed.

Configurable test set (Option 014)

With the configurable test set option, front panel access loops are provided to the signal path between the source output and coupler input.

Extended dynamic range configuration

Reverse the signal path in the coupler and bypass the loss typically associated with the coupled arm. Change the port 2 switch and coupler jumper configurations to increase the forward measurement dynamic range. When making full two-port error corrected measurements, the reverse dynamic range is degraded by 12 to 15 dB.

High power measurement configuration

Add external power amplifier(s) between the source output and coupler input to provide up to +30 dBm of power at the test port(s). Full two-port error correction measurements possible. When the DUT output is expected to be greater than +30 dBm, measure directly at the B input and use an external fixed or step attenuator to prevent damage to the receiver. For measurements greater than +30 dBm, add external components such as couplers, attenuators, and isolators.

Supplemental performance

Minimum reference channel input level: -35 dBm

Automation

	GPIB	LAN	Internal
SCPI	X	X	X
COM/DCOM		X	X

Methods

Controlling via internal analyzer execution

Write applications that can be executed from within the analyzer via COM (component object model) or SCPI standard-interface commands. These applications can be developed in a variety of languages, including Visual Basic, Visual C++, Agilent VEE, or LabView™ programming languages.

Controlling via GPIB

The GPIB interface operates to IEEE 488.2 and SCPI standard-interface commands. The analyzer can either be the system controller, or talker/listener.

Controlling via LAN

The built-in LAN interface and firmware support data transfer and control via direct connection to a 10 Base-T network.

SICL/LAN Interface

The analyzer's support for SICL (standard instrument control library) over the LAN provides control of the network analyzer using a variety of computing platforms, I/O interfaces, and operating systems. With SICL/LAN, the analyzer is controlled remotely over the LAN with the same methods used for a local analyzer connected directly to the computer via a GPIB interface.

DCOM Interface

The analyzer's support for DCOM (distributed component object model) over the LAN provides control of the network analyzer using a variety of platforms. DCOM acts as an interface to the analyzer for external applications. With DCOM, applications can be developed or executed from an external computer. During development, the application can interface to the analyzer over the LAN through the DCOM interface. Once development is completed, the application can be distributed to the analyzer and interfaced using COM.

Information resources

Literature

PNA Series RF and Microwave Network Analyzers Brochure,
literature number 5968-8472E
PNA Series Microwave Network Analyzer Configuration Guide,
literature number 5988-3993EN

Web

PNA Series: www.agilent.com/find/pna
Application and product resources:
www.agilent.com/find/test



Agilent Email Updates

www.agilent.com/find/emailupdates
Get the latest information on the products and applications you select.

Agilent Technologies' Test and Measurement Support, Services, and Assistance

Agilent Technologies aims to maximize the value you receive, while minimizing your risk and problems. We strive to ensure that you get the test and measurement capabilities you paid for and obtain the support you need. Our extensive support resources and services can help you choose the right Agilent products for your applications and apply them successfully. Every instrument and system we sell has a global warranty. Support is available for at least five years beyond the production life of the product. Two concepts underlie Agilent's overall support policy: "Our Promise" and "Your Advantage."

Our Promise

Our Promise means your Agilent test and measurement equipment will meet its advertised performance and functionality. When you are choosing new equipment, we will help you with product information, including realistic performance specifications and practical recommendations from experienced test engineers. When you use Agilent equipment, we can verify that it works properly, help with product operation, and provide basic measurement assistance for the use of specified capabilities, at no extra cost upon request. Many self-help tools are available.

Your Advantage

Your Advantage means that Agilent offers a wide range of additional expert test and measurement services, which you can purchase according to your unique technical and business needs. Solve problems efficiently and gain a competitive edge by contracting with us for calibration, extra-cost upgrades, out-of-warranty repairs, and on-site education and training, as well as design, system integration, project management, and other professional engineering services. Experienced Agilent engineers and technicians worldwide can help you maximize your productivity, optimize the return on investment of your Agilent instruments and systems, and obtain dependable measurement accuracy for the life of those products.

Get the latest information on the products and applications you select.

By internet, phone, or fax, get assistance with all your test & measurement needs

Online assistance:
www.agilent.com/find/assist

Phone or Fax

United States:
(tel) 800 452 4844

Canada:
(tel) 877 894 4414
(fax) 905 282 6495

China:
(tel) 800 810 0189
(fax) 800 820 2816

Europe:
(tel) (31 20) 547 2323
(fax) (31 20) 547 2390

Japan:
(tel) (81) 426 56 7832
(fax) (81) 426 56 7840

Korea:
(tel) (82 2) 2004 5004
(fax) (82 2) 2004 5115

Latin America:
(tel) (305) 269 7500
(fax) (305) 269 7599

Taiwan:
(tel) 0800 047 866
(fax) 0800 286 331

Other Asia Pacific Countries:
(tel) (65) 6375 8100
(fax) (65) 6836 0252
Email: tm_asia@agilent.com

Microsoft®, Windows® and MS-DOS® are U.S. registered trademarks of Microsoft Corporation.

National Instrument™ and LabView™ are trademarks of National Instruments Corporation.

Intel® and Pentium® are US registered trademarks of Intel Corporation.

Product specifications and descriptions in this document subject to change without notice.

© Agilent Technologies, Inc. 2002
Printed in USA, September 26, 2002
5988-3992EN



Agilent Technologies