

Agilent 8510C Network Analyzer

Data Sheet

45 MHz to 110 GHz

Discontinued Product Information — For Support Reference Only —

Information herein, may refer to products/services no longer supported. We regret any inconvenience caused by obsolete information. For the latest information on Agilent's test and measurement products go to: www.agilent.com/find/products

In the US, call Agilent Technologies at 1-800-829-4444
(any weekday between 8am–5pm in any U.S. time zone)

World-wide Agilent sales office contact information is available at: www.agilent.com/find/contactus

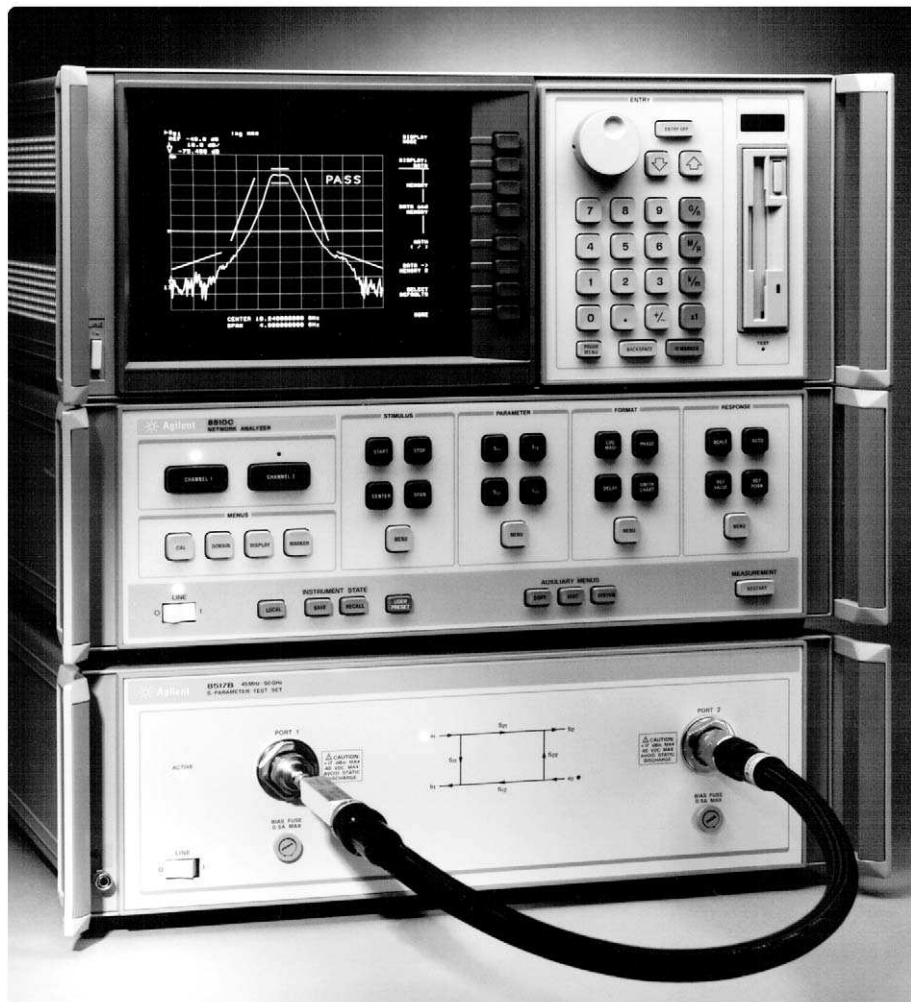

Contents

	Page
System performance characteristics	3
Major Agilent Technologies 8510 Network Analyzer Systems	
8510E , Option 005, 45 MHz to 20 GHz	4
8510SX , 45 MHz to 26.5 GHz	5
85107B Option 005, 45 MHz to 50 GHz	6
85107B Option 005 & 007, 45 MHz to 50 GHz	7
85106D millimeter-wave systems, 33 GHz to 110 GHz	7
8510XF, E7340A Option 005, 45 MHz to 85 GHz	8
8510XF, E7350A Option 005, 45 MHz to 110 GHz	10
85108A pulsed-RF system, 2 GHz to 20 GHz	12
85108L pulsed-RF system, 45 MHz to 2 GHz	12
8511A, 8511B frequency converters	13
Accuracy considerations	
when using RAMP sweep	14
8510C network analyzer capabilities	15
8510 System software	21
S-Parameter test sets , with common options	22
8510C Accessories	
(calibration kits, verification kits, and cables)	23

Excellence in Network Analysis

The **8510C vector network analyzer** continues to provide the best performance to meet your new design and test challenges. With unmatched accuracy and convenience, the 8510C vector network analyzer makes broadband measurements from 45 MHz to 50 GHz in 2.4 mm coax, from 45 MHz to 110 GHz in 1.0 mm coax and from 33 GHz to 110 GHz in waveguide bands.

The 8510C network analyzer measures the magnitude, phase, and group delay of two-port networks to characterize their linear behavior. Optionally, the 8510C network analyzer is also capable of displaying a network's time domain response to an impulse or a step waveform by computing the inverse Fourier transform of the frequency domain response.

The 8510C family of systems is modular. Choose the source(s), S-parameter test set(s), and test accessories to meet your measurement applications. This data sheet presents performance specifications for most standard 8510 network analyzer systems. To acquire specifications for system configurations not covered in this data sheet, refer to the 8510 Specifications and Performance Verification Software (part number 08510-10033) which is shipped with all 8510C network analyzers, test sets, and calibration kits.

System performance characteristics

This data sheet offers two types of performance numbers to describe the merit of any measurement system: specifications and supplemental characteristics.

Specifications describe the instrument's warranted performance over the temperature range of $23\text{ }^{\circ}\text{C} \pm 3\text{ }^{\circ}\text{C}$.

Supplemental characteristics are typical but non-warranted performance parameters. These are denoted as "typical," "nominal," or "approximate."

To specify the performance of an 8510 system, the data sheet lists each system's dynamic range, measurement uncertainty and measurement port characteristics. The glossary below explains the major terms used in the System Performance section of this data sheet.

DYNAMIC RANGE has two descriptions: receiver dynamic range and system dynamic range. In either case, the noise floor (which affects P_{\min} as defined below) is measured with full two-port error-correction and 1024 averages.

System dynamic range = $P_{\text{ref}} - P_{\min}$, where P_{ref} is the nominal or reference power out of port 1 with maximum power delivered from the source and P_{\min} is the minimum power into port 2 that can be measured above the peaks of the system's noise floor (10 dB above the average noise floor). System dynamic range is the amount of attenuation that can be measured from a 0 dB reference.

Receiver dynamic range = $P_{\max} - P_{\min}$, where P_{\max} is the maximum power that can be input to port 2 before 0.1 dB compression of the test set and P_{\min} is the minimum power into port 2 that can be measured above the peaks of the system's noise floor (10 dB above the average noise floor). Receiver dynamic range is the system's full usable dynamic range if the system is considered a receiver. An active device, such as an amplifier, may be required to realize the receiver dynamic range.

Calibration is the process of measuring standards which have fully defined models (and are thus called "known" standards) in order to quantify a network analyzer's systematic errors based on an error model.

Calibration must be performed within the operating temperature specified for the calibration kit. For all calibration kits the operating temperature is $23\text{ }^{\circ}\text{C} \pm 3\text{ }^{\circ}\text{C}$. For a calibration to remain fully verifiable, the temperature of the network analyzer must remain within $\pm 1\text{ }^{\circ}\text{C}$ around the initial measurement calibration temperature.

Error correction is the process of mathematically removing from the measurement those systematic errors determined by calibration.

MEASUREMENT UNCERTAINTY curves show the worst case uncertainty in reflection and transmission measurements using full two-port error correction with a specified calibration kit. This includes residual systematic errors, as well as system dynamic accuracy, connector repeatability, noise and detector errors. Cable stability and system drift are not included. All measurements assume step sweep mode with 1024 averages unless otherwise specified.

Furthermore, the graphs for reflection measurement uncertainty apply to a one-port device. The graphs for transmission measurement uncertainty assume a well-matched device ($S_{11} = S_{22} = 0$). In the phase uncertainty curves, the phase detector accuracy is better than 0.02 degrees, useful for measurements where only phase changes.

Using the 8510 specification and performance verification software, uncertainty curves can be calculated for non-idealized devices, and specifications can be edited for custom setups.

MEASUREMENT PORT CHARACTERISTICS indicate the RF performance of test set port leakages, mismatches, and frequency response. The specification for the test set's crosstalk does not include noise.

"Raw" port characteristics refer to the test set's intrinsic, uncorrected performance. **"Residual"** port characteristics give the test set's performance after error correction.

System performance

Agilent 8510E-005 45 MHz to 20 GHz

The following specifications describe the system performance for the 8510C network analyzer in the 8510E-005 (replaces 85052D fixed loads with 85052B sliding loads calibration kit) configuration. The system hardware includes the following:

Test set: 8514B S-parameter test set

RF source: 83621B synthesized sweeper

Calibration kit: 85052B 3.5mm calibration kit

Calibration technique: Full two-port calibration with sliding loads.

Dynamic range (for transmission measurements)

	Frequency range (GHz)		
	0.045–2	2–8	8–20
Maximum power measured at port 2	+20 dBm	+11 dBm	+10 dBm
Reference power at port 1 (nominal)	+2 dBm	-2 dBm	-6 dBm
Minimum power measured at port 2	-66 dBm	-95 dBm	-95 dBm
Receiver dynamic range	86 dB	106 dB	105 dB
System dynamic range	68 dB	93 dB	89 dB

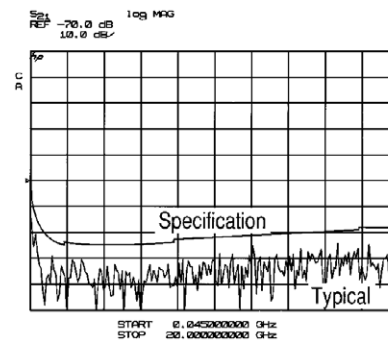

System dynamic range

Measurement uncertainty

Reflection measurements

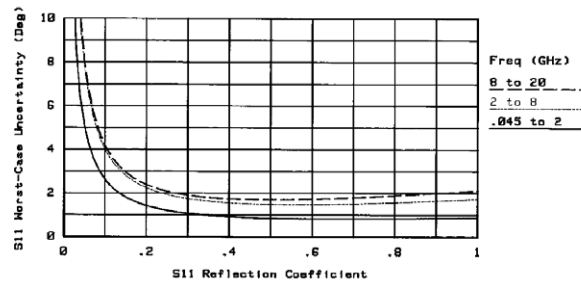
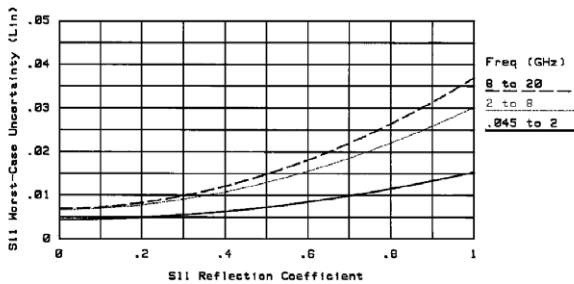

Magnitude

Transmission measurements

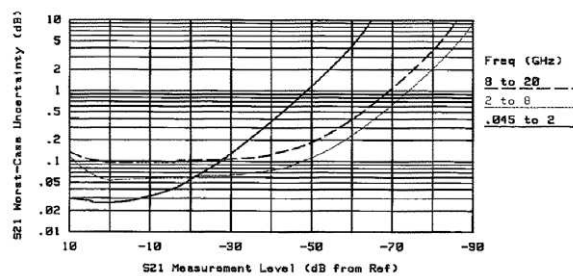

Phase

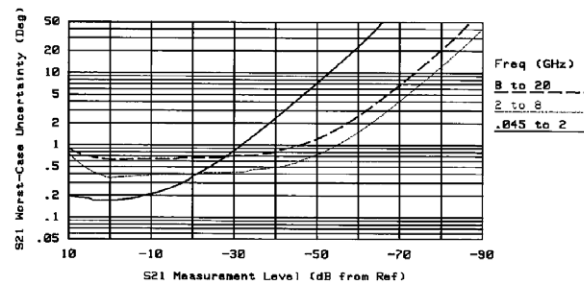

Magnitude

RESIDUAL	Frequency range (GHz)		
	0.045–2	2–8	8–20
Directivity	48 dB	44 dB	44 dB
Source match	40 dB	33 dB	31 dB
Load match	48 dB	44 dB	44 dB
Reflection tracking	±0.003 dB	±0.003 dB	±0.006 dB
Transmission tracking	±0.017 dB	±0.044 dB	±0.084 dB
Crosstalk	89 dB	115 dB	110 dB

Phase

RAW (Typical)	Frequency range (GHz)		
	0.045–2	2–8	8–20
Directivity	23 dB	23 dB	14 dB
Source match	17 dB	15 dB	11 dB
Load match	17 dB	15 dB	11 dB

Agilent 8510SX

45 MHz to 26.5 GHz

The following specifications describe the system performance for the 8510C network analyzer with the 8510SX configuration. The system hardware includes the following:

- Test set:** 8515A S-parameter test set
- RF source:** 83631B synthesized sweeper
- Calibration kit:** 85052C 3.5mm precision calibration kit
- Calibration technique:** TRL two-port calibration

Dynamic range (for transmission measurements)

	Frequency range (GHz)			
	0.045-2	2-8	8-20	20-26.5
Maximum power measured at port 2	+2 dBm	+3 dBm	+3 dBm	-1 dBm
Reference power at port 1 (nominal)	-5 dBm	-9 dBm	-14 dBm	-25 dBm
Minimum power measured at port 2	-98 dBm	-98 dBm	-100 dBm	-99 dBm
Receiver dynamic range	100 dB	101 dB	103 dB	98 dB
System dynamic range	93 dB	89 dB	86 dB	74 dB

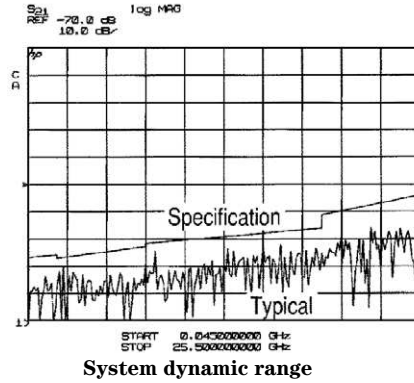

Measurement uncertainty

Reflection measurements

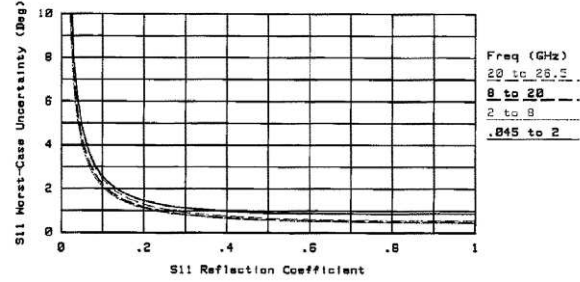
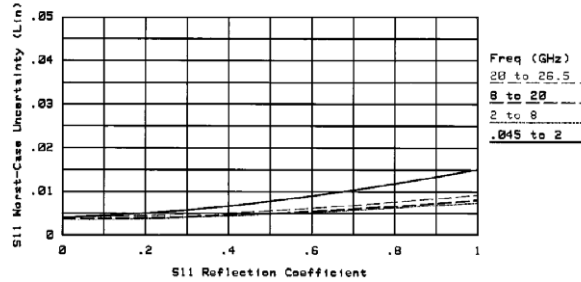

Magnitude

Phase

Transmission measurements

Measurement port characteristics

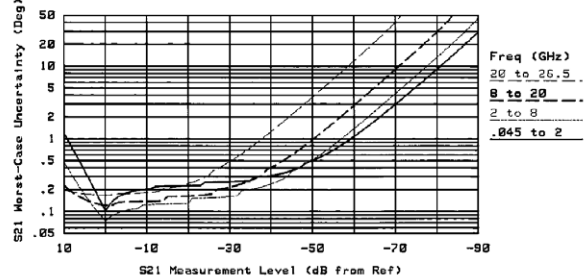
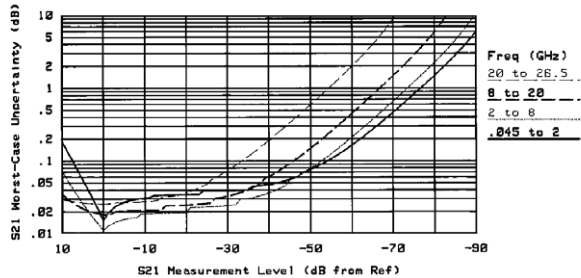

Magnitude

Phase

istics

RESIDUAL	Frequency range (GHz)			
	0.045-2	2-8	8-20	20-26.5
Directivity	48 dB	50 dB	50 dB	50 dB
Source match	40 dB	50 dB	50 dB	50 dB
Load match	48 dB	50 dB	50 dB	50 dB
Reflection tracking	±0.003 dB	±0 dB	±0 dB	±0 dB
Transmission tracking	±0.009 dB	±0.004 dB	±0.009 dB	±0.01 dB
Crosstalk	114 dB	111 dB	106 dB	95 dB

RAW (Typical)	Frequency range (GHz)			
	0.045-2	2-8	8-20	20-26.5
Directivity	24 dB	24 dB	28 dB	27 dB
Source match	23 dB	23 dB	16 dB	14 dB
Load match	23 dB	23 dB	16 dB	14 dB

Agilent 85107B-005

45 MHz to 50 GHz

The following specifications describe the system performance for the 8510C network analyzer in the 85107B-005 (adds step attenuators and bias tees to the 8517B test set) configuration for 50 GHz measurements. The system hardware includes the following:

- Test set:** 8517B S-parameter test set
- RF source:** 83651B synthesized sweeper
- Calibration kit:** 85056A 2.4mm calibration kit
- Calibration technique:** Full two-port calibration with sliding loads
- Dynamic range** (for transmission measurements)

	Frequency range (GHz)			
	0.045-2	2-20	20-40	40-50
Maximum power measured at port 2	+17 dBm	+8 dBm	+4 dBm	-3 dBm
Reference power at port 1 (nominal)	+1 dBm	-8 dBm	-19 dBm	-30 dBm
Minimum power measured at port 2	-76 dBm	-97 dBm	-91 dBm	-90 dBm
Receiver dynamic range	93 dB	105 dB	95 dB	87 dB
System dynamic range	77 dB	89 dB	72 dB	60 dB

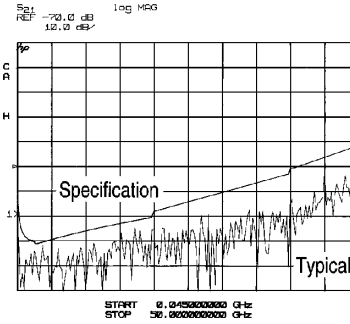

System dynamic range

Measurement uncertainty

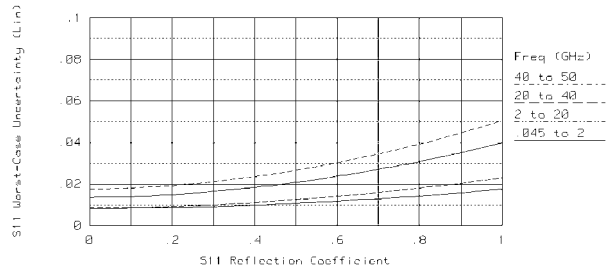

Magnitude

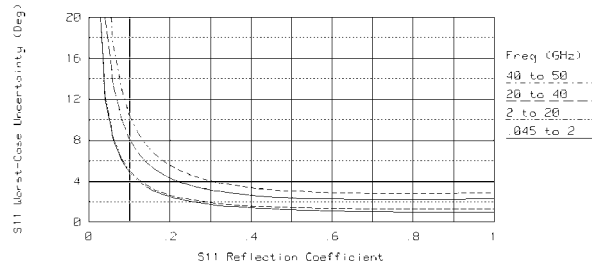

Phase

Reflection measurements

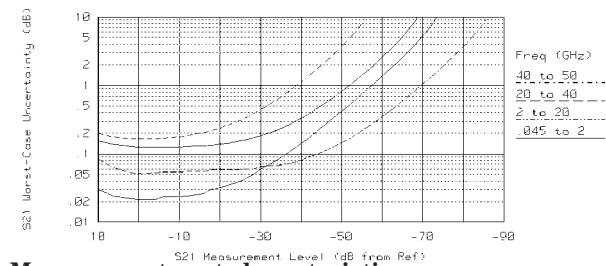

Measurement port characteristics
Magnitude

RESIDUAL	Frequency range (GHz)			
	0.045-2	2-20	20-40	40-50
Directivity	42 dB	42 dB	38 dB	36 dB
Source match	41 dB	38 dB	33 dB	31 dB
Load match	42 dB	42 dB	38 dB	36 dB
Reflection tracking	±0.001 dB	±0.008 dB	±0.02 dB	±0.027 dB
Transmission tracking	±0.014 dB	±0.043 dB	±0.110 dB	±0.137 dB
Crosstalk	99 dB	110 dB	93 dB	81 dB

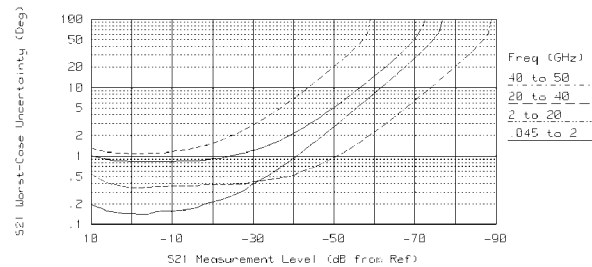

Phase

RAW (Typical)	Frequency range (GHz)			
	0.045-2	2-20	20-40	40-50
Directivity	22 dB	18 dB	18 dB	18 dB
Source match	20 dB	12 dB	9 dB	9 dB
Load match	20 dB	12 dB	9 dB	9 dB

Agilent 85107B-005, 007 45 MHz to 50 GHz

The following specifications describe the system performance for the 8510C network analyzer in the 85107B-005 (adds step attenuators and bias tees to the 8517B test set) and 85107B-007 (adds high power and high dynamic range to the 8517B test set) configuration for 50 GHz measurements. Specifications not shown are the same as those given for the 85107B-005. The system hardware includes the following:

Test set: 8517B-027, 8517B-003 S-parameter test set

RF source: 83651B synthesized sweeper

Calibration kit: 85056A 2.4mm calibration kit

Calibration technique: Full two-port calibration with sliding loads

Measurement uncertainty Transmission measurements

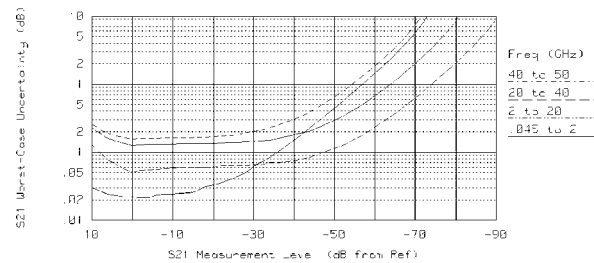

Dynamic range (for transmission measurements)

	Frequency range (GHz)			
	0.045–2	2–20	20–40	40–50
Maximum power measured at port 2	+17 dBm	+13 dBm	+6 dBm	-4 dBm
Reference power at port 1 (nominal)	+5 dBm	+2 dBm	-5 dBm	-16 dBm
Minimum power measured at port 2	-71 dBm	-92 dBm	-89 dBm	-91 dBm
Receiver dynamic range	88 dB	105 dB	95 dB	87 dB
System dynamic range	76 dB	94 dB	84 dB	75 dB

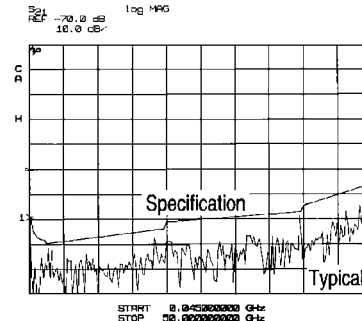

System dynamic range

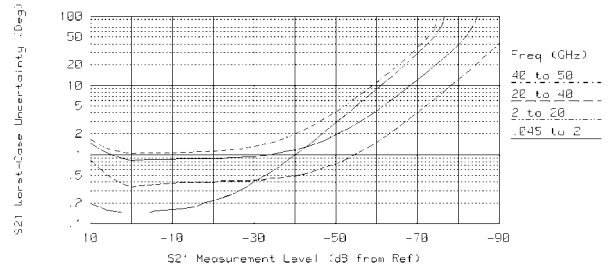

Agilent 85106D 33 GHz to 110 GHz

The following specifications describe the system performance for the 8510C network analyzer in the 85106D configuration for measurements from 33 to 110 GHz in four waveguide bands. For complete specifications, refer to the 85106D system data sheet. The system hardware includes the following:

Test set (two each): 85104A series millimeter-wave test set modules

RF sources (two): 83621B synthesized sweepers

Calibration kit: 11644A series waveguide calibration kit

Calibration technique: TRL two-port calibration

Dynamic range (for transmission measurements)

	Frequency range (GHz)			
	33–50	40–60	50–75	75–110
Maximum power measured at port 2	+12 dBm	+10 dBm	+10 dBm	0 dBm
Reference power at port 1 (nominal)	0 dBm	0 dBm	0 dBm	-3 dBm
Minimum power measured at port 2	-87 dBm	-87 dBm	-75 dBm	-79 dBm
Receiver dynamic range	99 dB	97 dB	85 dB	79 dB
System dynamic range	87 dB	87 dB	75 dB	76 dB

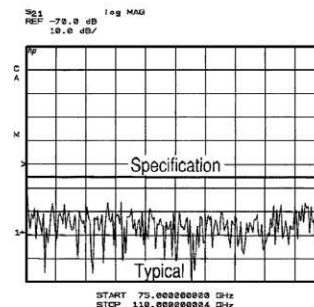

System dynamic range

Agilent 8510XF system performance E7340A-005 (45 MHz to 85 GHz)

The following specifications describe the system performance of the 8510XF system in the E7340A-005 configuration, from 0.045 GHz to 85 GHz. The following system configuration was used to generate the specifications:

Test set: E7342A-005, millimeter controller and two test heads, 45 MHz to 85 GHz

RF sources: 83621B and 83651B synthesized sweepers (one each)

Calibration kit: 85059A 1.0 mm precision calibration/verification kit

Calibration techniques: SOLT to 50 GHz, and offset-shorts from 50 to 85 GHz

Dynamic range (for transmission measurements)

	Frequency range (GHz)						
	0.045 - 2	2 - 18	18 - 40	40 - 50	50 - 65	65 - 75	75 - 85
Maximum power (in) measured at port 2	0 dBm	0 dBm	+10 dBm	+10 dBm	-3 dBm	-3 dBm	-3 dBm
Reference power (out) at port 1 (nominal)	0 dBm	0 dBm	-12 dBm	-12 dBm	-3 dBm	-3 dBm	-10 dBm
Minimum power (in) measured at port 2	-74 dBm	-104 dBm	-84 dBm	-84 dBm	-80 dBm	-80 dBm	-70 dBm
Receiver dynamic range	74 dB	104 dB	94 dB	94 dB	77 dB	77 dB	67 dB
System dynamic range	74 dB	104 dB	72 dB	72 dB	77 dB	77 dB	60 dB

Measurement port characteristics

RESIDUAL	Frequency range (GHz)						
	0.045 - 2	2 - 18	18 - 40	40 - 50	50 - 65	65 - 75	75 - 85
Directivity	30 dB	30 dB	26 dB	24 dB	28 dB	28 dB	28 dB
Source match	27 dB	27 dB	23 dB	21 dB	28 dB	28 dB	28 dB
Load match	27 dB	27 dB	23 dB	21 dB	28 dB	28 dB	28 dB
Reflection tracking	±0.10 dB	±0.10 dB	±0.20 dB	±0.25 dB	±0.30 dB	±0.30 dB	±0.30 dB
Transmission tracking	±0.273 dB	±0.273 dB	±0.429 dB	±0.669 dB	±0.322 dB	±0.340 dB	±0.360 dB

RAW (Typical)	Frequency range (GHz)						
	0.045 - 2	2 - 18	18 - 40	40 - 50	50 - 65	65 - 75	75 - 85
Directivity	20 dB	20 dB	15 dB	15 dB	13 dB	10 dB	10 dB
Source match	20 dB	20 dB	15 dB	15 dB	13 dB	12 dB	12 dB
Load match	11 dB	11 dB	10 dB	10 dB	10 dB	10 dB	10 dB

Measurement uncertainty

Reflection measurements

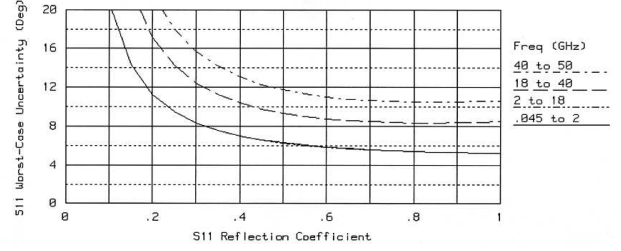
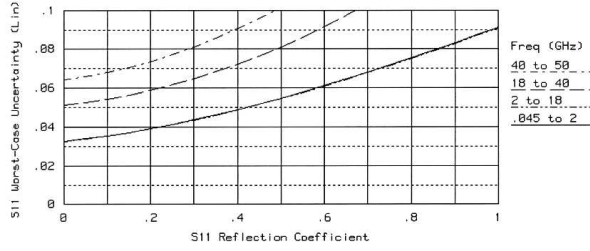

Magnitude



Phase

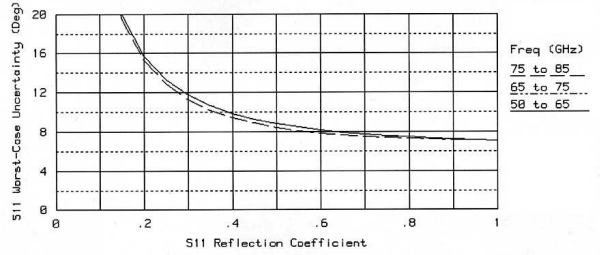

Magnitude

Transmission measurements

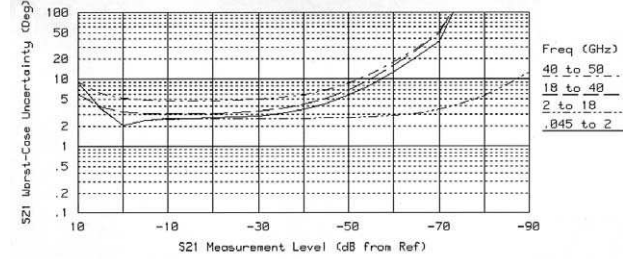
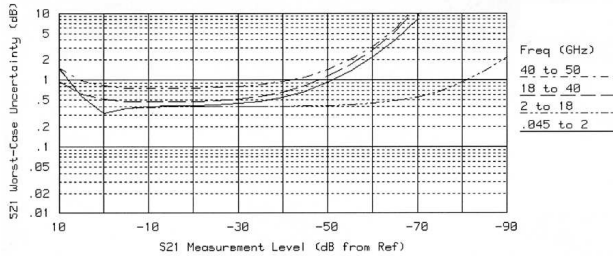

Magnitude

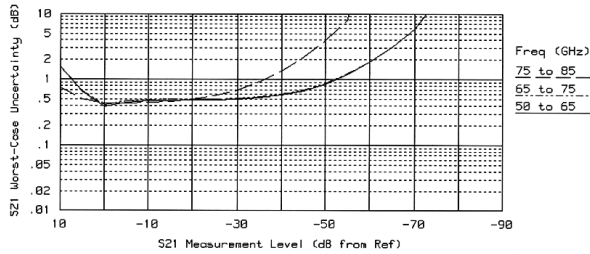

Phase

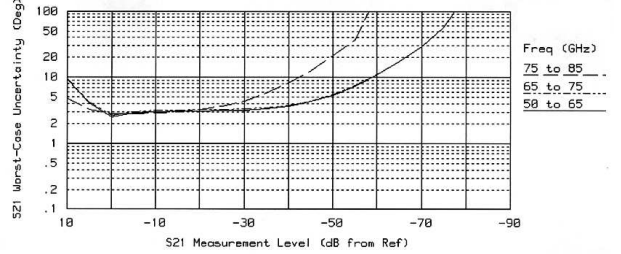

Magnitude

Phase

Agilent 8510XF system performance E7350A-005 (45 MHz to 110 GHz)

The following specifications describe the system performance of the 8510XF system in the E7350A-005 configuration, from 0.045 GHz to 110 GHz. The following system configuration was used to generate the specifications:

Test set: E7352A-005, millimeter controller and two test heads, 45 MHz to 110 GHz

RF sources: 83621B and 83651B synthesized sweepers (one each)

Calibration kit: 85059A 1.0 mm precision calibration/verification kit

Calibration techniques: SOLT to 50 GHz, and offset-shorts from 50 to 110 GHz

Dynamic range (for transmission measurements)

	Frequency range (GHz)							
	0.045 - 2	2 - 18	18 - 40	40 - 50	50 - 75	75 - 85	85 - 100	100 - 110
Maximum power (in)								
measured at port 2	0 dBm	0 dBm	+10 dBm	+10 dBm	0 dBm	0 dBm	0 dBm	0 dBm
Reference power (out)								
at port 1 (nominal)	0 dBm	0 dBm	-12 dBm	-12 dBm	-7 dBm	-12 dBm	-12 dBm	-12 dBm
Minimum power (in)								
measured at port 2	-74 dBm	-104 dBm	-84 dBm	-84 dBm	-75 dBm	-70 dBm	-70 dBm	-70 dBm
Receiver dynamic range	74 dB	104 dB	94 dB	94 dB	75 dB	70 dB	70 dB	70 dB
System dynamic range	74 dB	104 dB	72 dB	72 dB	68 dB	58 dB	58 dB	58 dB

Measurement port characteristics

RESIDUAL	Frequency range (GHz)							
	0.045 - 2	2 - 18	18 - 40	40 - 50	50 - 75	75 - 85	85 - 100	100 - 110
Directivity	30 dB	30 dB	26 dB	24 dB	28 dB	28 dB	26 dB	26 dB
Source match	27 dB	27 dB	23 dB	21 dB	28 dB	28 dB	26 dB	26 dB
Load match	27 dB	27 dB	23 dB	21 dB	28 dB	28 dB	26 dB	26 dB
Reflection tracking	±0.10 dB	±0.10 dB	±0.20 dB	±0.25 dB	±0.30 dB	±0.30 dB	±0.30 dB	±0.30 dB
Transmission tracking	±0.273 dB	±0.273 dB	±0.429 dB	±0.669 dB	±0.322 dB	±0.360 dB	±0.451 dB	±0.451 dB

RAW (Typical)	Frequency range (GHz)							
	0.045 - 2	2 - 18	18 - 40	40 - 50	50 - 75	75 - 85	85 - 100	100 - 110
Directivity	20 dB	20 dB	15 dB	15 dB	11 dB	11 dB	11 dB	8 dB
Source match	20 dB	20 dB	15 dB	15 dB	11 dB	11 dB	11 dB	10 dB
Load match	11 dB	11 dB	10 dB	10 dB	10 dB	10 dB	9 dB	9 dB

Measurement uncertainty

Reflection measurements

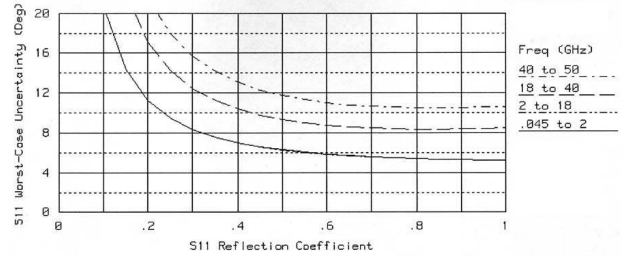
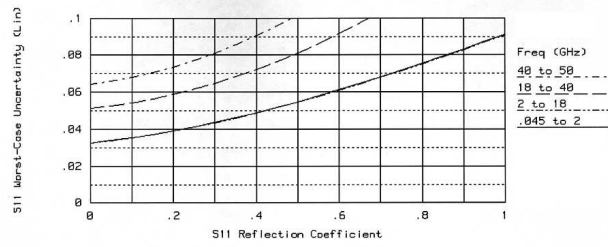

Magnitude

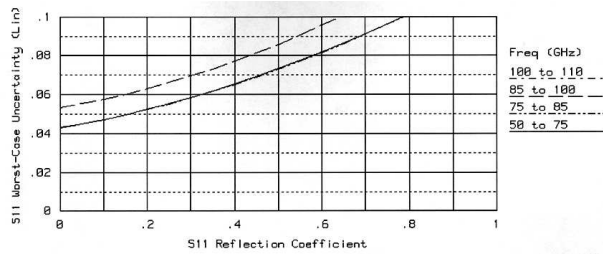

Phase

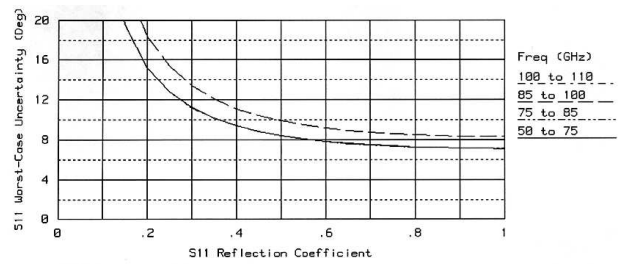

Magnitude

Transmission measurements

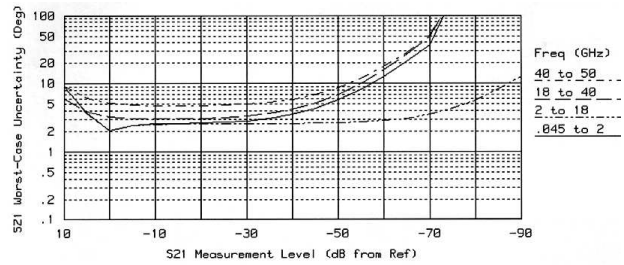
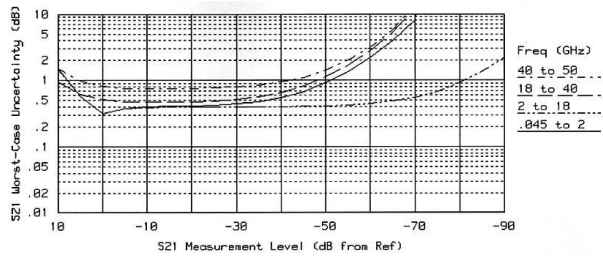

Magnitude

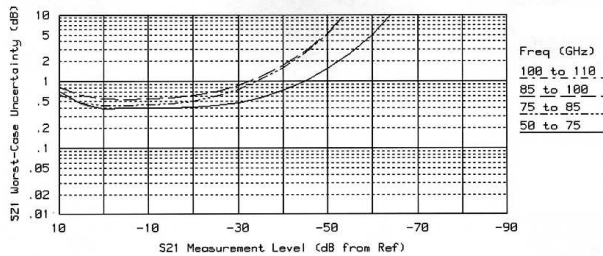

Phase

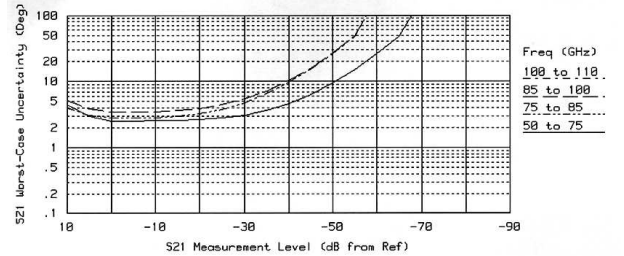

Magnitude

Phase

Agilent 85108A Pulsed-RF System 2 to 20 GHz

The following specifications describe the system performance for the 8510C network analyzer in 85108A configuration. For complete specifications, refer to the 85108A system data sheet. The system hardware includes the following:

Test set: 85110A S-parameter test set

RF sources (one each): 83622B and 83623L synthesized sweeper

Calibration kit: HP 85052B 3.5 mm calibration kit

Calibration technique: Full two-port calibration with sliding loads

Other capabilities such as 50 GHz frequency coverage, operating within synchronized pulsed bias, and measurements such as spectrum analysis, noise figure and load pull can be added easily without degradation of the raw system performance.

Dynamic range (for transmission measurements)

	Frequency range (GHz)		
	2–8	8–18	18–20
Maximum power (measured) at port 2 ¹	+11 dBm	+11 dBm	+11 dBm
Reference power at port 1 (nominal)	+0 dBm	–1 dBm	–2 dBm
Minimum power (measured) at port 2	(pulsed) –64 dBm (cw) –78 dBm	–63 dBm –78 dBm	–62 dBm –77 dBm
Receiver dynamic range	(pulsed) 75 dB (cw) 89 dB	74 dB 89 dB	73 dB 88 dB
System dynamic range	(pulsed) 64 dB (cw) 78 dB	62 dB 77 dB	60 dB 75 dB

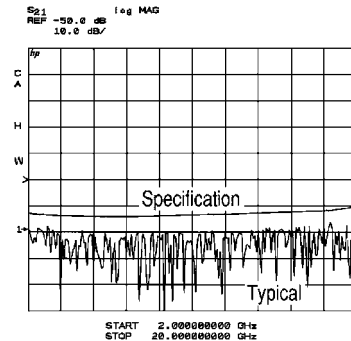

System dynamic range (pulsed)

Agilent 85108L Pulsed-RF system 45 MHz to 2 GHz

The following specifications describe the system performance for the 8510C network analyzer in 85108L configuration. For complete specifications, refer to the 85108L system data sheet. The system hardware includes the following:

Test set: 85110L S-parameter test set

RF sources (two each): 83620B-H80 synthesized sweeper

Calibration kit: 85050D 7 mm calibration kit

Calibration technique: Full two-port calibration with broadband loads

Dynamic range (for transmission measurements)

	Frequency range (GHz)		
	0.045–0.1	0.1–0.5	0.5–2
Maximum power (measured) at port 2 ²	+20 dBm	+6 dBm	+5 dBm
Reference power at port 1 (nominal)	+0 dBm	+1 dBm	0 dBm
Minimum power (measured) at port 2	(pulsed) –53 dBm (cw) –81 dBm	–66 dBm –95 dBm	–66 dBm –96 dBm
Receiver dynamic range	(pulsed) 72 dB (cw) 101 dB	72 dB 101 dB	72 dB 100 dB
System dynamic range	(pulsed) 53 dB (cw) 81 dB	67 dB 95 dB	66 dB 95 dB

1. This maximum power measurement assumes that the 85110A test set has its internal step attenuators set to 0 dB. The test set can handle up to 20 W (+43 dBm) of power if the step attenuators are activated and an isolator is installed (in the port 2 rear panel link).
2. This maximum power measurement assumes that the 85110L test set has its internal step attenuators set to 0 dB. The test set can handle up to 50 W (+47 dBm) of power if the step attenuators are activated and proper precautions are taken within the open architecture loops.

Agilent 8511A/8511B frequency converters

45 MHz to 26.5 GHz/45 MHz to 50 GHz

Description

Combining the 8511A or 8511B frequency converter with the 8510C network analyzer results in a four channel receiver/signal processor operating over a 45 MHz to 26.5 or 50 GHz frequency range. This system offers flexibility in the configuration of a user-supplied signal separation network to meet the needs of custom measurements. The 8511A/B contains four separate RF to IF converters all of which can operate over the entire dynamic range of the system. Either the a1 or a2 input must be defined as the reference channel to maintain phase lock and to track the RF source.

Dynamic accuracy

The following plots show the worst case magnitude and phase uncertainty due to IF residuals and detector inaccuracies. These plots exclude uncertainty due to noise, frequency response, directivity, port matches, crosstalk, and connector repeatability. Reference power is -20 dBm.

Measurement uncertainty

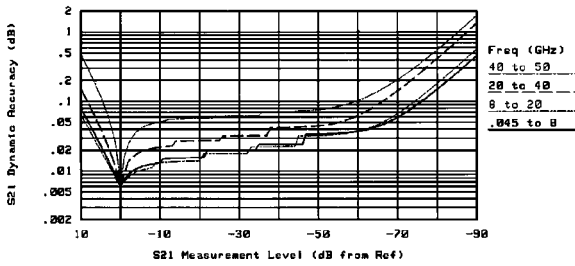

The following specifications describe the system performance for the 8510C network analyzer with the 8511A/B frequency converter.

Dynamic range (on all inputs)

	Frequency range (GHz)				
	0.045-8	8-20	20-26.5	26.5-40	40-50
Maximum power measured at port 2					
8511A	-10 dBm	-10 dBm	-15 dBm	—	—
8511B	-9 dBm	-8 dBm	-12 dBm	-12 dBm	-17 dBm
Reference power at port 1 (nominal)					
8511A	-20 dBm	-20 dBm	-20 dBm	—	—
8511B	-20 dBm	-20 dBm	-20 dBm	-20 dBm	-20 dBm
Minimum power measured at port 2					
8511A	-112 dBm	-115 dBm	-113 dBm	—	—
8511B	-113 dBm	-113 dBm	-106 dBm	-106 dBm	-104 dBm
Receiver dynamic range					
8511A	102 dB	105 dB	98 dB	—	—
8511B	104 dB	105 dB	94 dB	94 dB	87 dB
System dynamic range					
8511A	92 dB	95 dB	93 dB	—	—
8511B	93 dB	93 dB	86 dB	86 dB	84 dB

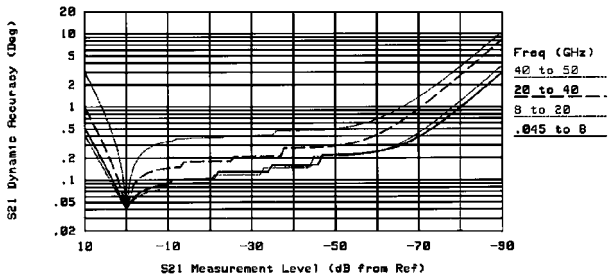

Phase

8511A general information

Input ports

Connector type (all inputs): 3.5 mm (f)
Impedance: 50 Ω nominal

8511B general information

Input ports

Connector type (all inputs): 2.4 mm (f)
Impedance: 50 Ω nominal

Magnitude

Input port characteristics

The following specifications show the uncorrected system characteristics at the four measurement ports.

	Frequency range (GHz)				
	0.045-8	8-20	20-26.5	26.5-40	40-50
Impedance match (all four ports)					
8511A	17 dB	15 dB	9 dB	—	—
8511B	17 dB	15 dB	9 dB	9 dB	7 dB
Frequency response tracking¹					
8511A	±1 dB	±1 dB	±1 dB	—	—
8511B	±1 dB	±1 dB	±3 dB	±3 dB	±3 dB
Crosstalk²					
8511A	115 dB	116 dB	114 dB	—	—
8511B	116 dB	114 dB	107 dB	107 dB	105 dB

1. Ratio measurement of any two ports, excludes slope.
2. After error-correction, response and isolation calibration assumes no noise.

Accuracy considerations when using ramp sweep

The uncertainty values for the preceding systems assume that the microwave source operates in the synthesized step sweep mode. Selecting ramp sweep saves time; the 8510C allows switching between step and ramp sweep without the need to recalibrate¹.

The frequency accuracy of the 8510 in ramp sweep mode is determined by the swept frequency accuracy of the source.

For 8360 series synthesizers, the swept frequency accuracy is summarized in the following table:

Sweep width		Accuracy (% of span, or MHz)
f ≤ 26.5 GHz	f > 26.5 GHz	
≤ n x 10 MHz	≤ n x 10 MHz	0.1% ± time base accuracy
> n x 10 MHz and ≤ 400 MHz	> n x 10 MHz and ≤ 800 MHz	1%
> 400 MHz and ≤ 4 GHz	> 800 MHz and ≤ 8 GHz	4 MHz/8 MHz
> 4 GHz	> 8 GHz	0.1%

Frequency range	n (Multiplier)
10 MHz to < 2 GHz	1
2 to < 7 GHz	1
7 to < 13.5 GHz	2
13.5 to < 20 GHz	3
20 to < 26.5 GHz	4
26.5 to < 38 GHz ²	6
38 to 50 GHz	8

The plots below indicate the typical swept mode accuracy.

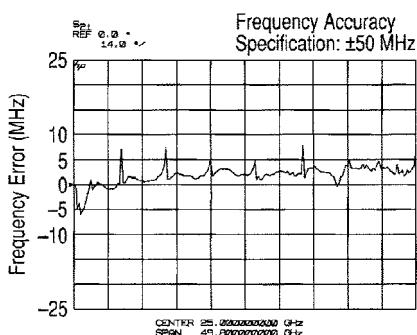
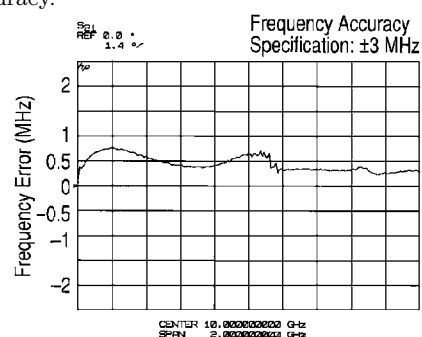

1. Ramp sweep mode is not available in the 8510XF systems.
2. This band is 26.5 to 40 GHz on the 83640A.

Phase errors due to device electrical length

Ramp sweep adds phase uncertainty to the measurement of electrically long devices. The phase uncertainty $\Delta\phi$ is given by the following equation:

$$\Delta\phi = (-360/c) \times \Delta F \times L$$

where c is the propagation velocity in a vacuum (3×10^{10} cm/sec), ΔF is the frequency accuracy specification of the synthesizer in ramp mode, and L is the electrical length of the device under test. The following graph shows this uncertainty for the 8360 series synthesizers in ramp sweep.

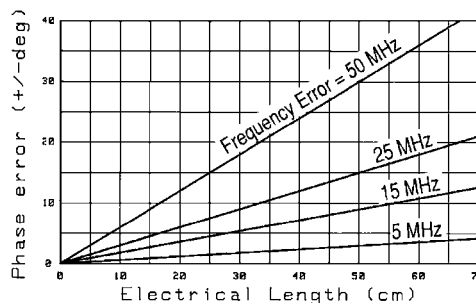

Agilent Technologies recommends the 8360 series synthesized sweepers in step sweep mode whenever measuring phase or group delay of electrically long devices, or whenever the highest system accuracy is required. Ramp sweep is recommended for measurements of electrically short devices, or for applications where maximum trace update rate is desired (for example, tuning).

System capabilities¹

Measurement

Number of display channels: Two display channels are available.

Number of display parameters: The four basic parameters, S11, S21, S12, S22, can be displayed for either selected channel in either a “four quadrant” or an “overlay” format.

Measurement parameters: S11, S21, S12, S22.

Parameters may be redefined by the user for special applications. Conversion to Z1 (input impedance), Z2 (output impedance), Y1 (input admittance), Y2 (output admittance), and 1/S is also provided.

Domains available: Frequency, time (Option 010), pulse profile² (Option 008), auxiliary voltage (rear panel output acting as device stimulus, range is ±10 VDC), and power³ (sweep power level at a CW frequency).

Formats

Cartesian: log/linear magnitude, phase, group delay, SWR, real part of complex parameter, imaginary part of complex parameter.

Smith chart: Marker format can be selected as log magnitude, linear magnitude, R + jX, or G + jB.

Polar: Marker format can be selected as log magnitude, linear magnitude, phase, or real and imaginary.

Data markers: Five independent data markers read out and display the value of the formatted parameter and stimulus (frequency, time, or auxiliary voltage).

Marker functions

Marker search: Specific trace values can be located, such as MAX, MIN, and target (for example -3.00 dB point)

Discrete/continuous: Markers can indicate data at actual data points or they can interpolate between data points to allow the setting of a marker at an exact stimulus value.

Delta marker: Marker readout shows difference between active marker and the reference marker (any marker can be used as the reference).

Group delay characteristics

Group delay is computed by measuring the phase change within a specified step (determined by the frequency span and the number of points per sweep).

Aperture: Determined by the frequency span, the number of steps per sweep, and the amount of smoothing applied.

Minimum aperture = (frequency span)/(# points - 1)

Maximum aperture = 20% of the frequency span

Range: The maximum delay is limited to measuring no more than ±180 degrees of phase change within the minimum aperture.

$$\text{Range} = 1/(2 \times \text{minimum aperture})$$

For example, with a minimum aperture of 200 kHz, the maximum delay that can be measured is 2.5 μsec.

Accuracy: The following graph shows group delay accuracy at 20 GHz with an 8514B test set and an 83621A operating in stepped sweep mode. Insertion loss is assumed to be zero.

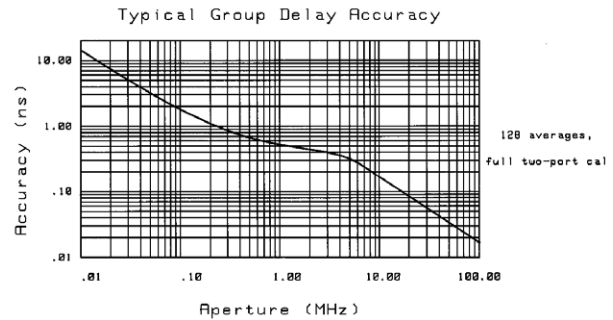

In general, the following formula can be used to determine the accuracy, in seconds, of a specific group delay measurement.

$$\frac{0.003 \times \text{Phase accuracy (deg)} + \text{delay (sec)} \times \text{linearity (Hz)}}{\text{Aperture (Hz)}}$$

Depending on the aperture and the device length, the phase accuracy used is either incremental phase accuracy or worst case phase accuracy. The above graph shows this transition.

Source control

All source control is provided from the 8510C front panel.

Compatible sources

8360 series synthesized sweeper

8340A/B synthesized sweeper⁴

8341A/B synthesized sweeper⁴

8350B sweep oscillator with 835xx RF plug-in⁴ (ramp sweep mode only)

Sweep limits: Set start/stop or center/span of the stimulus parameter (frequency, time, or auxiliary voltage).

Measured # points per sweep: Selectable as 51, 101, 201, 401, or 801 points. In frequency list mode, the number of points can range from 1 to 792.

Sweep modes

*Ramp sweep*⁵ (analog)

Stepped sweep (available with all sources except the Agilent 8350B): A faster version of step sweep, called “quick step”, is selectable when using an 8360 series synthesized sweeper.

Frequency list sweep: Define up to 30 different arbitrary sub-sweep frequency ranges by specifying start/stop, center/span, or CW sweeps. Define the number of points or step size for each range. Display all segments or a single segment on-screen. All frequencies are synthesized if using the 8340/41 or 8360 series synthesized sweepers. Frequency domain only.

Single point (single frequency)

Fast CW mode (GPIB only): Raw data (real and imaginary) is sent immediately to GPIB as soon as it is taken. Display is blanked in this mode. The source is phase-locked once when entering this mode, but is not re-phase-locked at each point. Must be triggered externally (TTL). Data is available approximately 500 μsec after the trigger pulse is received.

1. The symbol ¹ denotes a new feature or capability due to the 8510C firmware revision 7.0.

2. Pulse profile domain is not available in the 8510XF systems.

3. Power domain requires 8360 series sources. Sources with firmware revisions prior to 01 Oct 93 require updating.

4. The 8340, 8341 and 8350 series sources are not compatible with the 8510XF systems.

5. Ramp sweep mode is not available in the 8510XF systems.

Power sweep: From power domain, sweep power at a CW frequency. When combined with the receiver calibration feature, power sweep allows quicker and more accurate absolute-power measurements of an amplifier's 1 dB gain compression point.

Alternate sweep: The two channels, including markers, may be coupled¹ (same source parameters) or uncoupled (different source parameters).

Sweep time: Minimum sweep time is automatically selected, depending on the number of points per sweep (and the averaging factor if in stepped mode). Longer sweep times may be entered by the user from 0.1 to 100 seconds.

Source power: Set source power (dBm) or power slope (dBm/GHz). For the S-parameter test sets with built-in attenuators, the port 1 or port 2 signal level can be controlled by setting the internal attenuator of the test set. Flat power is achievable at the test port when using the user-flatness feature of the 8360 series synthesizers. An E4418A power meter with the 8480 series of power sensors are required to measure power for flatness correction.

Multiple frequency control mode: In this mode, the 8510C controls up to three frequency ranges independently: the frequency of the primary source (83621A synthesized sweeper), the frequency of a secondary source (may be phase-locked 8350B sweep oscillator), and the frequency of the network analyzer receiver.

Frequency control: All frequency ranges can be separately defined as functions of the device under test frequency, by specifying a multiplier (a ratio of integers) and an offset for each frequency.

Definition storage: The active multiple frequency mode parameters are stored in non-volatile memory and may be saved on disc with the hardware configuration.

Sweep modes: All sweep modes can be used in multiple frequency mode.

External LO phase-lock control: In applications where an external LO is used in place of a test set, LO phase-lock control is provided to phase-lock a sweep oscillator with DC FM capability (for example, 8350B) to a synthesized sweeper (for example, 83621A).

Power leveling and power control²

Power leveling capability comes as part of the standard 8510XF systems. With power leveling, power levels at the test ports are controlled with a typical accuracy of ± 1.0 dB with a control range greater than 20 dB.

Power leveling modes: These modes are available in both RF and LO power control.

System leveling: Power leveled at the test ports and is entirely controlled by the 8510XF system. This is also the normal operating mode.

Internal leveling: Power leveled at the output port of the source.

External leveling: Leveling is achieved using an external detector.

Leveling off: Source set to the unleveled mode.

Power leveling detections modes: These modes are available under system leveling. Each mode will determine how the "unleveled" condition is detected.

Always: The 8510C polls for errors during every sweep.

Smart: The 8510C polls for errors during the first sweep following a change in frequency, and thereafter only if an error was detected during the first sweep. This is the default mode.

Once: The 8510C polls for errors only during the first sweep following a change in frequency.

Never: The 8510C does not poll for errors during any sweep.

Power control: Set port power (dBm) or power slope (dBm/GHz). With system leveling selected, the 8510XF system will control the RF source, the millimeter-wave controller and the test heads to deliver the user requested power to the test ports.

Vector error correction techniques

Calibration types available: Various calibration types are available. Once calibrated, the frequency limits may be narrowed using the FREQUENCY SUBSET feature of the 8510C.

Response/isolation calibration: Compensates for frequency response and directivity (reflection) or frequency response and crosstalk (transmission) of test sets. Requires a short or open circuit and load termination (reflection) or through connection and load termination (transmission).

One port calibration: Correction of test set port 1 or port 2 directivity response and source match errors. Requires three known standards, for example, open, short, and load (fixed, sliding, or offset) terminations.

Two port calibration: Compensates for port 1 and port 2 directivity, source match, reflection frequency response, load match, transmission, frequency response and crosstalk. Crosstalk (isolation) calibration can be eliminated.

Full two-port (traditional): For use with an S-parameter test set, requires three known standards at each port, for example, short, open (or offset short), and load (fixed, sliding, or offset) terminations. A through connection is also required.

One path two-port calibration: A two-port calibration for one port Reflection/Transmission test sets, such as the millimeter-wave systems, provides a full two-port error-corrected measurement when the test device is turned around and measured in both directions.

1. In the 8510XF systems, the two channels are coupled (uncoupled channels is not available).

2. The features or capabilities listed under Power Leveling and Power Control are only available in the 8510XF systems.

Thru-reflect-line (TRL): A two-port calibration which requires a through connection, a reflection standard, and a reference transmission line. S-parameter test sets only.

Line-reflect-match (LRM): A two-port calibration similar to TRL except it uses fixed loads and not transmission line(s) as its impedance reference. LRM is a particularly convenient broadband calibration for non-coaxial environments with accuracy as good as TRL. S-parameter test sets only.

Adapter removal calibration: A two-port calibration for noninsertable devices, such as those with identical sexed connectors on both ports. S-parameter test sets only.

Two-port to one-port calibration: Create and store a separate one-port calibration set for either port 1 or port 2 from an existing two-port calibration.

Reference plane extension: Redefine the plane of measurement reference (zero phase) to other than that established at calibration. A new reference plane is defined in seconds of delay from the test set port and ranges between ± 1 second.

Connector compensation: Compensates for errors between dissimilar but matable connectors such as 3.5 mm and SMA.

Receiver cal: Adjusts non-ratioed receiver inputs to absolute power levels; displays absolute power in dBm; requires reference sweep of known source power (using flatness correction).

Set Zo: Can redefine the characteristic impedance of a measurement to other than 50 Ω .

Data averaging: Similar to a variable bandwidth IF filter, this function computes the running average of either a number of data traces in ramp mode or data points in stepped mode. Averaging factors range from 1 to 4096 in powers of 2. In stepped sweep mode, each data point is averaged before being displayed.

Trace smoothing: Similar to variable bandwidth video filter, this function computes the moving average of adjacent data points in a single trace. Smoothing aperture ranges from 0.125% to 20% of the trace width.

Data hardcopy

Data plotting: Hard copy plots are automatically produced by the 8510C when used with an HP-GL compatible plotter using either the system bus (GPIB compatible) or serial output interface (RS-232-C).

Plotter functions: Plot trace(s), graticule(s), marker(s), or text with any plotter pen. Operating and system parameters can also be plotted.

Formats: Full or quarter page plots of any parameter.

Plot all 4 S-parameters: Plots all four S-parameters in 4-quadrant format.

Plotter/printer buffer: Retain trace update of the 8510 while plotting/printing previous data via either of the two serial output interface (RS-232-C) ports. Total buffer memory available is 400 Kbytes for serial output port 1 and 100 Kbytes for serial output port 2.

Data listings: For printing and plotting, the Agilent 8510C can send data, via either its GPIB¹ or its RS-232 interface, to the HP ThinkJet, QuietJet, DeskJet, LaserJet, or PaintJet graphics printers. Measurement data, operating parameters and system parameters can all be printed or plotted.

Display control

Display type: Color (raster scan), 7.5" diagonal; display graticule, 5.5" diagonal.

Title: Add custom titles (49 characters maximum) to the display of the 8510C. Titles are plotted when making hardcopies of displayed measurements.

Adjust display: Control the intensity and background intensity of the display. Also, customize the color, tint, and brightness of the data traces, memory traces, reference lines, graticules, text, and warning messages. Select from 16 colors. Default colors can be recalled along with one set of user-defined display values. Control is in the percent of full range.

Limit lines: Define up to eight test limit segments per parameter per channel; segments may be any combination of flat lines, sloping lines, or discrete points; limit testing gives pass/fail decision on each sweep.

CRT formats: Single channel, dual channel overlay (both traces on one graticule), dual channel split (each trace on separate graticules), four parameter overlay or split.

Trace functions

Display data: Display current measurement data, memory data, or current measurement and memory data simultaneously.

Trace math: Vector math (+, -, \times , \div) of current linear measurement values and memory data.

Scale resolution

Magnitude: Log format (dB/div): 0.001 to 500

Linear format (units/div): 10×10^{-12} to 500

Phase: Cartesian (degrees/div): 10×10^{-12} to 500

Polar (degrees/display graticule): 45

Reference value: Ranges between ± 500 units (dB, degrees, seconds, etc.)

Reference position: Ranges from the 0 (bottom) to 10 (top) graticule position.

Auto: Automatically selects scale resolution and reference value to center the trace on the CRT graticules for easy viewing.

Electrical delay: Offset measured phase or group delay data by a defined amount of electrical delay, in seconds. Operates similar to an electronic line stretcher. Amount of electrical delay can range between ± 1 second. Electrical delay can also be displayed in electrical length (meters) or physical length by entering the appropriate VELOCITY FACTOR, the propagation velocity relative to the speed of light.

Waveguide delay: Non-linear electrical delay used to remove the effects of dispersion in waveguide.

Table delay: Allows user to input an array or real and imaginary pairs to correct for dispersion in non-coaxial media such as microstrip or coplanar waveguide.

1. When printing/plotting from the 8510 system bus (GPIB compatible) port to a Centronics printer/plotter, use an ITEL-45CHVU or ITEL-45CHVE HP-to-Centronics Converter.

Storage

Internal memory

Instrument state: Eight instrument states can be stored in non-volatile memory via the SAVE menu. They can then be recalled via the RECALL menu. Instrument states include all control settings, memory trace data, active list frequency tables, active calibration coefficients, and custom display titles. Register 8 is reserved for the power-up state, which can be defined by the user.

Hardware configurations: One hardware configuration is stored in active non-volatile memory. This configuration is not changed at instrument preset. The hardware configuration includes all instrument addresses and the multiple frequency mode parameters.

Data traces: Eight traces of data can be stored in the trace memories. Traces 1-4 are stored in non-volatile memory.

Calibration sets: Eight separate calibration sets may be stored in non-volatile memory. If any 801-point full two-port calibrations are stored, storage may be limited to as few as four calibration sets.

Calibration kits: Two calibration kits, including user-modified kits can be stored in the 8510 internally allocated memory. An internally stored kit is written over when another calibration kit is loaded in the same data storage location. Calibration kits can also be stored to disk.

Internal disk drive: The built-in disk drive can be used to store and retrieve different types of data on a 3.5 inch disk. Data files can be stored in either the HP LIF or MS-DOS® formats. Diskettes of double sided format or high density format are recommended.

External disk drive: Data can also be stored on disk using an external disk drive with command subset SS/80. Data files are stored in Hewlett-Packard's standard LIF or MS-DOS format.

Disk storage memory requirements

Type of Data to be Stored	Memory Required (Kbytes)
Calibration set (full two-port, 801 pts)	234
Calibration kit	2
Instrument state	7
Hardware state	0.5
Machine dump	400
Data data (201 pts)	
1 S-parameter	5.5
4 S-parameters	20
Data formatted, raw or memory (201 pts)	5.5
User display	33

Time domain (Option 010)

Description

With the time domain option, data from transmission or reflection measurements is converted from the frequency domain to the time domain using the inverse Fourier transform and presented on the CRT display. The time domain response shows the measured parameter value versus time. Markers may also be displayed in electrical length (or physical length if the relative propagation velocity is entered).

Time stimulus modes

Two types of time domain stimulus waveforms can be simulated during the transformation — a step and an impulse. Although these waveforms are generated mathematically with the inverse FFT, the results for linear circuits are the same as would be obtained if the actual time waveforms had been applied and measured.

Low pass step: This stimulus, similar to a traditional Time Domain Reflectometer (TDR) waveform, is used to measure low pass devices. Transforming to time low pass requires a sweep over a harmonic set of frequencies including an extrapolated DC value. The step response is typically used for reflection measurements only. The low pass step waveform displays a different response for each type of impedance (R, L, C), giving useful information about the discontinuities being measured.

Response resolution¹: In low pass step mode, response resolution is determined by the step rise time (10% to 90%) of the time stimulus. This depends on both the frequency span and the window used (see Windows):

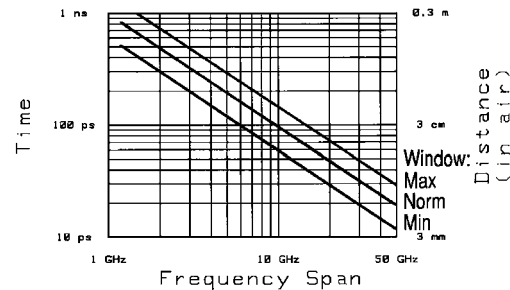

Low pass impulse: This stimulus is also used to measure low pass devices, and is the mathematical derivative of the low pass step response. Transforming to time low pass requires a sweep over a harmonic set of frequencies including an extrapolated DC value. The time domain response shows changes in the parameter value versus time. The impulse response can be used for reflection (fault location) or transmission measurements.

Response resolution¹: In low pass impulse mode, response resolution is defined by the 50% impulse width of the time stimulus. This depends on both the frequency span and the window used (see Windows):

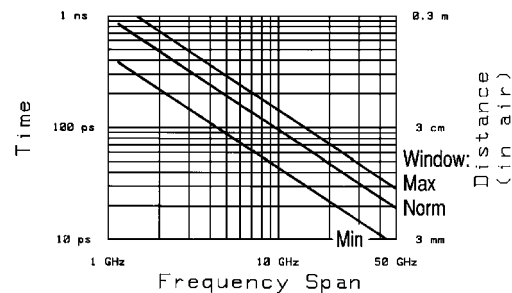

1. Response resolution is the ability to resolve two closely spaced responses of equal magnitude. For example, in time impulse response, two equal responses that are separated in time by less than one impulse width cannot be resolved as two separate responses.

Bandpass impulse: The bandpass impulse simulates a pulsed RF signal (with an impulse envelope) and is used to measure the time domain response of band-limited devices. The start and stop frequencies are selectable by the user to any values within the limits of the source and test set used. The bandpass time domain response shows changes in the parameter values versus time. Bandpass time domain responses are useful for both reflection and transmission measurements.

Response resolution¹: In bandpass impulse mode, response resolution is defined by the 50% impulse width of the time stimulus. This depends on both the frequency span and the window used (see Windows):

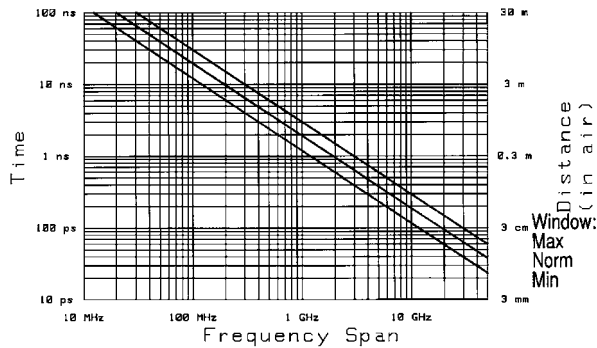

Time domain range

The time domain range, the range over which the display is free of response repetition, depends on the frequency span and the number of points as shown in the following graph²:

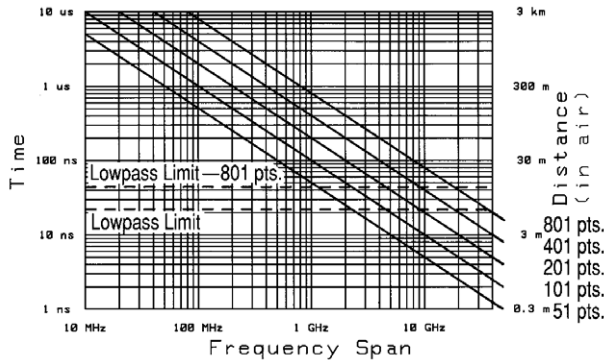

Range resolution: Range-resolution is the ability to locate a single response in time. It is a function of the time span selected and the number of data points. Range-resolution = time span/(number of points -1). Range-resolution better than 1 mm (3 ps) can typically be achieved. This is determined by source stability.

Windows: The windowing function can be used to modify (filter) the frequency domain data to reduce overshoot and ringing in the Time Domain response. Three types of windows are available—minimum, normal, maximum. Typical effective impulse width and sidelobe response to each type of window are shown in the table below:

Window type	Kaiseressel parameter	Impulse width	Sidelobes (relative to peak)
Minimum	0	Minimum	-15 dB
Normal	6	1.5x Minimum	-50 dB
Maximum	13	2.5x Minimum	-90 dB

Gating: The gating function can be used to isolate individual Time Domain responses. In converting back to the frequency domain the effects of the responses outside the gate are removed. The location and span of the gate can be controlled by setting either the gate center position and time span or by setting the gate start and stop times.

Measurement throughput summary

The following table shows typical measurement times for an 8510C system with full two-port error correction.

	Number of points				
	51	101	201	401	801
Measurement³					
Ramp sweep⁴	270 ms	340 ms	470 ms	740 ms	1.3 s
Stepped sweep					
Avg factor = 1	1.25 s	2.5 s	5 s	10 s	20 s
Avg factor = 128	6.25 s	12.8 s	24 s	49 s	106 s
Time domain conversion⁵	50 ms	100 ms	200 ms	400 ms	800 ms
 GPIB data transfer to computer⁶					
Internal format	20 ms	30 ms	50 ms	100 ms	200 ms
ASCII format	240 ms	460 ms	900 ms	1.8 s	3.6 s
IEEE 754 floating point format					
32 bit	20 ms	40 ms	80 ms	160 ms	320 ms
64 bit	40 ms	80 ms	150 ms	300 ms	590 ms

Remote programming

Interface: GPIB interface operates according to IEEE 488-1978 and IEC 625 standards and IEEE 728-1982 recommended practices.

System interface: The 8510C system bus is a GPIB port used exclusively by the 8510C to control and extract information from the other instruments in the system such as the RF source, test set, and the digital plotter.

Addressing: The GPIB addresses of the 8510C and all instruments connected to the 8510 system interface can be verified or set from the 8510C front panel via the LOCAL menu. Addresses can range from 0 to 30 decimal.

- Response resolution is the ability to resolve two closely spaced responses of equal magnitude. For example, in time impulse response, two equal responses that are separated in time by less than one impulse width cannot be resolved as two separate responses.
- In low pass mode (step or impulse), range is limited by the minimum spacing between frequency domain data points (45 MHz, or 22.5 MHz with 801 points). This limit is labeled on the graph as "low pass limit".
- Includes system retrace time, but does not include source bandswitch times (typically 50 msec each). Time domain gating is assumed off.
- If averaging is used, multiply the above ramp sweep measurement times by the averaging factor to get the total time.
- Option 010 only, gating off.
- Measured with an HP 9000 Series 300 computer. Single point data transfers can be accomplished in approximately 1 msec per point using the fast CW mode.

The factory selected addresses are the following:

8510C network analyzer	16
Source #1	19
Source #2	18
Test set	20
Plotter	05
Printer	01
Disc drive	00
Pass-through address	17

Pass-through address: Instruments connected to the 8510C system bus may be accessed via the pass-through address.

Transfer formats:

Binary (internal 48 bit floating point complex format)
 ASCII
 32/64 bit IEEE 754 floating point format
 Form 5 (for transfer to PC's)

Interface function codes:

SH1, AH1, T6, TE0, L4, LE0, SR1, RL1, PPO, DC1, DT0, CO, E1

General characteristics

Rear panel connectors

Sweep in: Input for 0 to 10 V sweep voltage from compatible sweep oscillator.

Stop sweep: Input and output for stop sweep signal from compatible sweep oscillator.

10 MHz in: Input for external 10 MHz reference.

Input level: -10 dBm to +20 dBm, typical

Input frequency accuracy: ±0.005% (50 ppm)

20 MHz out: Output of internal 20 MHz reference oscillator.

Frequency accuracy: ±0.01%, typical

Analog ±10V: Settable output voltage used for auxiliary voltage domain measurements, or analog output for analog recorders.

Range: -9.995 to +10.000 volts

Linearity: ±0.1%, typical

Resolution: 4.88 mV, nominal

Output impedance: 1k Ω

External trigger: TTL input to trigger acquisition of single data point. Delay is included to equalize the single path delay from the test port. Data is taken on negative-going TTL pulse.

Pulse repetition period: 1 msec minimum with no averaging. If averaging, add (200 μs x averaging factor).

Pulse width: 1 μs minimum.

Environmental

Operating conditions: Temperature: 5 °C to 40 °C

Non-operating conditions: Temperature: -40 °C to +75 °C

Power

47.5 to 66 Hz: 100, 120, 200, 240 Vac, ±10%

8510C: 460 VA, maximum

Test sets: 145 VA, maximum

8510XF millimeter-subsystem: 500 VA, maximum

Weight

8510C: Net, 42 kg (92 lb); shipping, 52 kg (114 lb)

8511A/B: Net, 15 kg (33 lb); shipping, 18 kg (40 lb)

8514B: Net, 17 kg (38 lb); shipping, 20 kg (45 lb)

8515A: Net, 19 kg (41 lb); shipping, 22 kg (48 lb)

8517B: Net, 15.5 kg (34.2 lb); shipping, 18.7 kg (41.2 lb)

85105A: Net, 20.4 kg (45 lb); shipping, 24.5 kg (54 lb)

85104A series modules (each): Net, 6 kg (23 lb);

shipping 6.8 kg (15 lb)

8510XF controller: Net, 20.4 kg (45 lb); shipping, 24.5 kg (54 lb)

8510XF test heads (each): Net, 11.34 kg (25 lb);

shipping, 13.6 kg (30 lb)

Dimensions

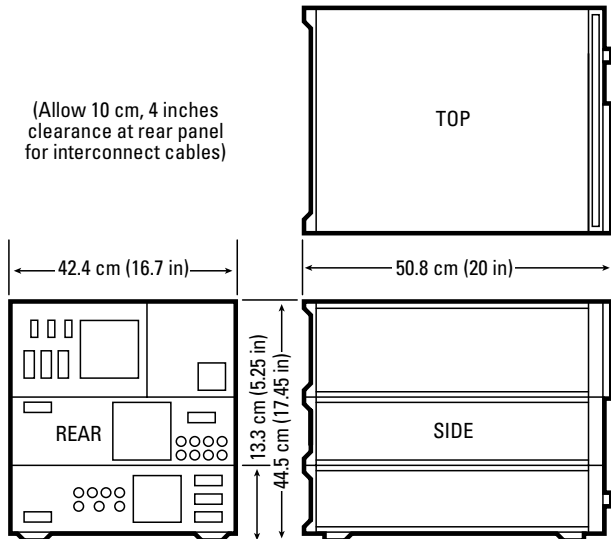

System Software

Agilent 85161B measurement automation software

Description: This software is designed specifically to operate on an HP 9000 Series 200 or 300 computer for automation of the 8510 system including millimeter-wave systems. The software complements the hardware, providing calibration, measurement, and data output capabilities with a minimum of operator interaction. Measurement data can be stored in binary format or in a data file compatible with many CAE design programs.

Operating requirements

Compatible with an HP 9000 Series 200 or 300 computer with the following:

BASIC Operating System (5.0 or higher)

RAM memory (including BASIC): 2 Mbytes, or a PC running Basic for Windows revision 6.3 or higher under Windows (3.1/95/NT)

Agilent 85071B materials measurement software

Description: The 85071B software takes broad-band S-parameter measurements of dielectric and magnetic materials and determines their electromagnetic properties. The software calculates both the complex permittivity ϵ_r (or dielectric constant) and permeability μ_r , including their loss factors. Depending on the network analyzer and fixtures used, measurements can extend from 100 MHz to 110 GHz. The software offers the choice of four algorithms, each designed to address specific measurement needs.

Operating requirements

Standard: Requires MS-DOS on an HP Vectra (or any 100%-compatible PC-AT computer) compatible with Microsoft® Windows 2.11 with mouse. Requires >20 Mbyte hard disk and >640 Kbytes RAM.

Option 300: Substitutes BASIC software for the standard version for operation with the 9000 Series 300 controllers. Requires BASIC 5.0 or higher and 2 Mbytes of RAM.

Refer to the 85071B data sheet for more information.

Agilent 85070B dielectric probe kit

The 85070B dielectric probe kit allows convenient non-destructive testing of materials using the open-ended coaxial probe method. The probe, together with its own dedicated software, determines the complex permittivity of a wide variety of liquids, semi-solids, and solids. Since the probe kit measures only permittivity, only non-magnetic materials should be measured. Measurements are efficient and cost-effective because the testing is non-destructive and there is no need for sample preparation or special fixtures. Refer to the 85070B data sheet for more information.

S-parameter test sets

Description

Combining the 8510C network analyzer with an 8514B, 8515A, or 8517B results in a system for making full S-parameter measurements. The dual port architecture of the test sets develops a separate reference channel for each incident port. RF switching is done with a single built-in electronic switch.



Test set general information

	8514B	8515A	8517B	85110A	85110L	85105A/85104A			
Frequency range (GHz)	0.045 to 20	0.045 to 26.5	0.045 to 50	2 to 20	0.045 to 2	33 to 50	40 to 60	50 to 75	75 to 110
Test ports (port 1 or 2)									
Nominal operating power level (dBm)	2 to -6	-5 to -25	+2 to -29 +5 to -16 ¹	0 to -3	0	0	0	0	-3
Connector type	3.5 mm (m)	3.5 mm (m)	2.4 mm (m)	3.5 mm (m)	7 mm	WR-22	WR-19	WR-15	WR-10
Impedance, DC bias	50 Ω nominal, 500 mA, 40 Vdc maximum					Waveguide impedance, no bias			
Attenuation range (incident signal)	0 to 90 dB, in 10 dB steps		0 to 60 dB, in 10 dB steps	0 to 90 dB, in 10 dB steps		N/A	N/A	N/A	N/A
RF input connector (rear panel)									
Max. input power	+16 dBm	+14 dBm	+16 dBm	+14 dBm	+14 dBm	+13 dBm	+13 dBm	+13 dBm	+13 dBm
Connector type	3.5 mm (f)	3.5 mm (f)	2.4 mm (f)	3.5 mm (f)	3.5 mm (f)	3.5 mm (f)	3.5 mm (f)	3.5 mm (f)	3.5 mm (f)

Various configurations are available for all test sets. Please see the 8510 Network Analyzer Configuration Guide.

1. 8517B Option 007

Agilent 8510C accessories

A wide range of accessories support the 8510C network analyzer including calibration kits, verification kits, cables and adapters in 7 mm, 3.5 mm, 2.92 mm, Type-N, 2.4 mm, 1.85 mm and 1.0 mm coax and in the standard waveguide bands. The standards used in the 3.5 mm, Type-N, and 2.4 mm calibration and verification kits use precision slotless connectors¹ (PSC-3.5, PSC-N, and PSC-2.4).

Calibration kits

Before a network analyzer can make error-corrected measurements, the network analyzer's systematic errors must be measured and removed. Calibration is the process of quantifying these errors by measuring "known", or precision standards. The calibration kits listed below contain the precision mechanical standards required to calibrate an 8510 system. For calibrating an 8510 system in the 7 mm, 3.5 mm, 2.92 mm, Type-N, 2.4 mm, 1.85 mm, or 1.0 mm interface, mechanical calibration kits all contain the following:

- Calibration standards to perform full-two port calibration
- Torque wrenches for properly connecting the standards
- Adapters to change the sex of the test port
- A disk for loading the standard definitions into the network analyzer. Option 002² provides calibration standard definitions on magnetic tape for use with the 8510A/B.

Three classes of mechanical calibration kits are available: **Standard kits** contain open circuits, short circuits, and both fixed and sliding terminations in both sexes for all connector types (except 7 mm, a sexless connector). Connector gauges are included in these kits for maintaining each standard's connector interface.

Precision kits have precision 50 Ω airline(s) for performing the Thru-Reflect-Line (TRL) calibration², the most accurate error-correction technique for coaxial measurements. These kits also contain the open circuit, short circuit, and fixed terminations used for traditional open-short-load calibration techniques. All precision kits except the 85052C and 85059A include gauges.

All waveguide calibration kits are precision kits and support TRL calibration in their waveguide band. Most kits contain two straight waveguide sections with precision flanges, a flush short circuit, a precision waveguide line section, and either sliding or fixed terminations.

Economy kits include the open circuit, short circuit, and fixed termination standards but not sliding terminations or gauges. Gauges can be ordered separately.

Cal kit type and name	Frequency range (GHz) f_{\min} – f_{\max}	Connector type	Return loss, fixed load	Return loss, sliding load	Return loss (dB), airline @ f_{\max}	Residual directivity (dB) @ f_{\max}	Residual source match (dB) @ f_{\max}
STANDARD							
85050B	0.045–18	7 mm	≥ 52 dB, DC–2 GHz	≥ 52 dB, 2–18 GHz	—	52	41
85052B	0.045–26.5	3.5 mm	≥ 44 dB, DC–3 GHz	≥ 44 dB, 3–26.5 GHz	—	44	31
85054B	0.045–18	Type-N	≥ 48 dB, DC–2 GHz	≥ 42 dB, 2–18 GHz	—	42	32
85056A	0.045–50	2.4 mm	≥ 42 dB, DC–4 GHz	≥ 36 dB @ 50 GHz	—	36	32
PRECISION							
85050C	0.045–18	7 mm	≥ 38 dB, DC–18 GHz	—	>60	60	60
85052C	0.045–26.5	3.5 mm	≥ 46 dB, DC–2 GHz	—	50	50	50
85059A	0.045–110	1.0 mm	≥ 24 dB, DC–50 GHz	—	—	24	21
X11644A ¹	8.2–12.4	WR-90	≥ 42 dB, 8.2–12.4 GHz	—	50	50	50
P11644A ¹	12.4–18	WR-62	≥ 42 dB, 12.4–18 GHz	—	50	50	50
K11644A ¹	18–26.5	WR-42	≥ 42 dB, 18–26.5 GHz	—	50	50	50
R11644A	26.5–40	WR-28	—	≥ 46 dB	50	50	50
Q11644A	33–50	WR-22	—	≥ 46 dB	50	50	50
U11644A	40–60	WR-19	—	≥ 46 dB	50	50	50
V11644A	50–75	WR-15	≥ 38 dB	—	50	50	50
W11644A	75–110	WR-10	≥ 36 dB	—	50	46	46
ECONOMY							
85050D	0.045–18	7 mm	≥ 38 dB, DC–18 GHz	—	—	40	35
85052D	0.045–26.5	3.5 mm	≥ 30 dB @ 26.5 GHz	—	—	30	25
85054D	0.045–18	Type-N	≥ 34 dB @ 18 GHz	—	—	34	28
85056D	0.045–50	2.4 mm	≥ 26 dB @ 50 GHz	—	—	26	23

1. Precision slotless connectors provide greater accuracy and repeatability than standard connectors because the impedance does not change when it is connected to a device.

2. Not available with the 85059A calibration kit

Electronic calibration

Electronic calibration (ECal) is a precision, single connection, one- or two-port calibration technique that uses fully traceable and verifiable electronic impedance standards. ECal replaces the traditional calibration technique that uses mechanical standards. ECal requires fewer connections. It removes the intensive operator interaction, which is prone to errors. A full two-port calibration can be accomplished with a single connection of the ECal module and minimal operator interaction. This results in a faster and more repeatable calibration. Calibrations for non-insertable devices are equally convenient and straight forward.

ECal modules are controlled manually or automatically via the 85097A PC interface module with control software. The 85097A consists of a PC interface module, control software and a power supply.

The Agilent 85090 family of RF ECal modules provides calibration across the complete frequency range of the 8753C/D/E vector network analyzers. The 85060 family of microwave ECal modules provides calibrations through 26.5 GHz for the 8510B/C and 8719/20/22C/D vector network analyzers.

ECal modules and available options^{A, B}

Connector type ¹	Frequency range	ECal module model number	Available options
7 mm	30 kHz to 6 GHz ²	85091A	1BN, 1BP, 910, UK6
7 mm	1 GHz to 18 GHz	85060B	001, 1BN, 1BP, 910, UK6
Type-N	30 kHz to 6 GHz ²	85092A	00F, 00M, 00A, 1BN, 1BP, 910, UK6
Type-N	1 GHz to 18 GHz	85064B	001, 00F, 00M, 00A, 1BN, 1BP, 910, UK6
3.5 mm	30 kHz to 6 GHz ²	85093A	00F, 00M, 00A, 1BN, 1BP, 910, UK6
3.5 mm	1 GHz to 26.5 GHz	85062B	001, 00F, 00M, 00A, 1BN, 1BP, 910, UK6

Options

Option	Description
001	Adds a 30 kHz to 6 GHz RF module ²
00F	Replace f/m connectors on ECal module(s) with f/f connectors
00M	Replace f/m connectors on ECal module(s) with m/m connectors
00A	Adds male-to-male and female-to-female adapters (also adds a 5/16" 90 N-cm (8 in-lb) torque wrench to 3.5 mm modules)
1BN	Mil-STD 45662 calibration certificate
1BP	Mil-STD 45662 calibration certificate with measured data
910	Add an extra operating and service manual
UK6	Commercial calibration certificate with measured data

An 85097A PC interface module with control software must be ordered to drive all ECal modules. The 85097A requires a customer-supplied PC meeting the following minimum requirements:

- Windows 95®, Windows NT 4.0® or later operating system
- 486 or later CPU
- 32 MB of RAM
- 10 MB available hard-disk space
- one of the following GPIB interface cards:
82340A/B, 82341C/D, National AT-GPIB/TNT, National AT-GPIB/TNT (*plug&play*) or National PCI-GPIB

1. For ECal modules with sexed (m-f) connectors, the standard modules have one female and one male connector.
2. RF ECal modules are specified to operate from 300 kHz to 6 GHz, with typical performance down to 30 kHz.
A. 85060 series modules cover a frequency range of 1 GHz to either 18 or 26.5 GHz. The upper frequency is limited by the connector cutoff frequency. Each module is supplied with a torque wrench and foam-padded wood storage box.
B. 85090 series modules cover a frequency range of 30 kHz to 6 GHz. Each module is supplied with a torque wrench and foam-padded wood storage box.

Verification kits

Verification kits are used to verify that a network analyzer is operating within its specified performance. Agilent Technologies offers verification kits that include precision airlines, mismatch airlines, and precision fixed attenuators. All verification kits include measurement data and uncertainties which are traceable to the U.S. National Institute of Standards and Technology (NIST).

Verification kits

Verification kit	Connector type	Frequency range (GHz)	Description (Contents)
85051B	7 mm	0.045–18	10 cm airline, stepped impedance airline, 20 dB, and 50 dB attenuators
85053B	3.5 mm	0.045–26.5	7.5 cm airline, stepped impedance airline 20 dB, and 40 dB attenuators
85055A	Type-N	0.045–18	10 cm airline, stepped impedance airline, 20 dB and 50 dB attenuators
85057B	2.4 mm	0.045–50	50 Ω airline, stepped impedance airline, 20 dB and 40 dB attenuators
R11645A	WR-28	26.5–40	All contain:
Q11645A	WR-22	33–50	Standard waveguide section
U11645A	WR-19	40–60	Standard waveguide mismatch
V11645A	WR-15	50–75	20 dB attenuator
W11645A	WR-10	75–110	50 dB attenuator

Test port return cables

Test port cables are available in the 7 mm, 3.5 mm, Type-N, 2.4 mm, and 1.0 mm connector types¹. The configurations and performance for all cables are described in the tables on the opposite page. All cable ends connect directly to the special rugged test port of the network analyzer test set.

Agilent offers two cable designs: semi-rigid and flexible. Semi-rigid cables offer excellent performance and are suitable for applications where the connectors of the DUT are “in-line” or parallel. Flexible cables are ideal for manufacturing environments since they are more rugged and have a tighter bending radius than semi-rigid cables. Semi-rigid cables are warranted for 90 days; flexible cables are warranted for one year.

Either a single long cable or a shorter cable set can connect a coaxial device to the test set. A single cable with an appropriate test port adapter is best for applications where the DUT requires a connection next to the test port for mechanical rigidity. A set of cables offers the flexibility required to position the test devices away from the test set.

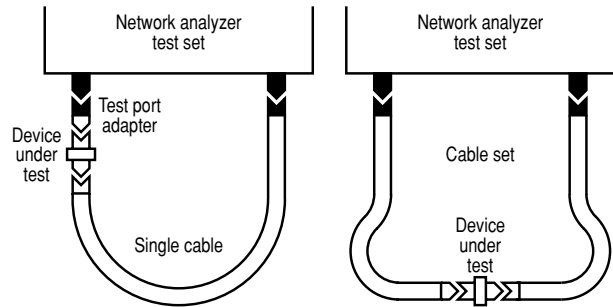

Test port adapter sets

The 85130 series test port adapter sets protect the test set port when connecting devices to the test port. These adapters convert the rugged test set port to a connection that can be mated with the device under test. Each set contains a male and a female adapter.

Adapter sets

Adapter set	Connector type (test port to device)	Frequency (DC– f_{max})	Return loss (dB) @ f_{max}
85130C	3.5 mm ² to Type-N	DC–18 GHz	≥28
85130D	3.5 mm ² to PSC-3.5 mm (f) or 3.5 mm (m)	DC–26.5 GHz	≥28
85130E	2.4 mm ² to 7 mm	DC–18 GHz	≥26
85130F	2.4 mm ² to PSC-3.5 mm (f) or 3.5 mm (m)	DC–26.5 GHz	≥26
85130G	2.4 mm ² to PSC-2.4 mm (f) or 2.4 mm (m)	DC–50 GHz	≥23
11904S	2.4 mm ² to 2.92 mm (4)	DC–40 GHz	≥28

Waveguide to 1.0 mm adapter kits

Adapter kit	Frequency range	Description (contents)
V85104A K10	DC–75 GHz	WR-15 to 1.0 mm (f) adapters (4) and 1.0 mm coax cables (2)
W85104A K10	DC–110 GHz	WR-10 to 1.0 mm (f) adapters (4) and 1.0 mm coax cables (2)

85043C racked system kit

85043C racked system kit is a rack standing 132 cm (52 in) high, with a width of 60 cm (23.6 in), and a depth of 80 cm (32 in). Complete with support rails and AC power distribution (suitable for 50 to 60 Hz, 100 to 240 VAC), the kit includes rack mounting hardware for all instruments. Thermal design is such that no rack fan is needed.

Bias networks

The 11612 bias networks apply DC as close to the device as possible, bypassing the test set's internal shunt resistor. These bias networks are especially useful when measuring DC parameters of semiconductor devices.

Model number	Frequency range	Maximum current	Maximum voltage
11612A K10/K20³	45 MHz–26.5 GHz	0.5 amps	40 volts
11612A K12/K22³	400 MHz–26.5 GHz	2.0 amps	40 volts
11612B K11/K21³	45 MHz–50 GHz	0.5 amps	40 volts

- To measure Type-N devices, use a pair of 7 mm cables and the 7 mm-to-Type-N adapters provided in the 85054B, D calibration kits.
- Special rugged female connector specifically for connecting to the network analyzer test port, but does not mate with a standard male connector
- Special option number K1x refers to port 1, K2x refers to port 2

Test port return cable specifications

Single cables for the 8514B and 8515A test sets (3.5 mm)

	Connector type (test port to device)	Frequency (GHz)	Length ² cm (inch)	Return loss (dB)	Insertion loss (dB) (f in GHz)	Stability ^{1, 2} ±magnitude (dB)	±Phase (degrees)
85131C semi-rigid cable	3.5 mm ³ to PSC-3.5 mm (f)	DC–26.5	81 (32)	≥17	0.43 √f +0.3 (2.5 dB @ f _{max})	<0.06	0.16 (f) +0.5
85131E flexible cable	3.5 mm ³ to PSC-3.5 mm (f)	DC–26.5	96.5 (38)	≥16	0.35 √f +0.3 (2.1 dB @ f _{max})	<0.22	0.16 (f) +0.8
85132C semi-rigid cable	3.5 mm ³ to 7 mm	DC–18	81 (32)	≥17	0.35 √f +0.3 (1.8 dB @ f _{max})	<0.06	0.16 (f) +0.5
85132E flexible cable	3.5 mm ³ to 7 mm	DC–18	97.2 (38.25)	≥17	0.35 √f +0.3 (1.8 dB @ f _{max})	<0.22	0.16 (f) +0.8

Cable set for the 8514B and 8515A test sets (3.5 mm)

	Connector type (test port to device)	Frequency (GHz)	Length ² cm (inch)	Return loss (dB)	Insertion loss (dB) (f in GHz)	Stability ^{1, 2} ±magnitude (dB)	±Phase (degrees)
85131D semi-rigid cable set	3.5 mm ³ to PSC-3.5 mm (f) or 3.5 mm (m)	DC–26.5	53 (21)	≥16	0.30 √f +0.2 (1.8 dB @ f _{max})	<0.06	0.16 (f) +0.5
85131F flexible cable set	3.5 mm ³ to PSC-3.5 mm (f) or 3.5 mm (m)	DC–26.5	62.2 (24.5)	≥16	0.25 √f +0.2 (1.5 dB @ f _{max})	<0.12	0.13 (f) +0.5
85132D semi-rigid cable set	3.5 mm ³ to 7 mm	DC–18	53 (21)	≥17	0.25 √f +0.2 (1.3 dB @ f _{max})	<0.06	0.16 (f) +0.5
85132F flexible cable set	3.5 mm ³ to 7 mm	DC–18	62.9 (24.75)	≥17	0.25 √f +0.2 (1.3 dB @ f _{max})	<0.12	0.13 (f) +0.5

Single cables for the 8517B test set (2.4 mm)

	Connector type (test port to device)	Frequency (GHz)	Length ² cm (inch)	Return loss (dB)	Insertion loss (dB) (f in GHz)	Stability ^{1, 2} ±magnitude (dB)	±Phase (degrees)
85133C semi-rigid cable	2.4 mm ³ to PSC-2.4 mm (f)	DC–50	81 (32)	≥15	0.84 √f +0.3 (5.6 dB @ f _{max})	<0.06	0.18 (f)
85133E flexible cable	2.4 mm ³ to PSC-2.4 mm (f)	DC–50	113 (44)	≥12.5	0.58 √f +0.35 (4.45 dB @ f _{max})	<0.25	0.8 +0.16 (f)
85134C semi-rigid cable	2.4 mm ³ to PSC-3.5 mm (f)	DC–26.5	81 (32)	≥16	0.46 √f +0.3 (2.7 dB @ f _{max})	<0.06	0.18 (f)
85134E flexible cable	2.4 mm ³ to PSC-3.5 mm (f)	DC–26.5	97.2 (38.25)	≥16	0.46 √f +0.3 (2.7 dB @ f _{max})	<0.22	0.16 (f) +0.8
85135C semi-rigid cable	2.4 mm ³ to 7 mm	DC–18	81 (32)	≥17	0.46 √f +0.3 (2.25 dB @ f _{max})	<0.06	0.18 (f)
85135E flexible cable	2.4 mm ³ to 7 mm	DC–18	97.2 (38.25)	≥17	0.46 √f +0.3 (2.25 dB @ f _{max})	<0.22	0.16 (f) +0.8

Cable set for the 8517B test set (2.4 mm)

	Connector type (test port to device)	Frequency (GHz)	Length ² cm (inch)	Return loss (dB)	Insertion loss (dB) (f in GHz)	Stability ^{1, 2} ±magnitude (dB)	±Phase (degrees)
85133D semi-rigid cable set	2.4 mm ³ to PSC-2.4 mm (f) or 2.4 mm (m)	DC–50	53 (21)	≥15	0.55 √f +0.2 (3.7 dB @ f _{max})	<0.06	0.16 (f)
85133F flexible cable set	2.4 mm ³ to PSC-2.4 mm (f) or 2.4 mm (m)	DC–50	72 (28)	≥12.5	0.48 √f +0.25 (3.64 dB @ f _{max})	<0.17	0.8 +0.16 (f)
85134D semi-rigid cable set	2.4 mm ³ to PSC-3.5 mm (f) or 3.5 mm (m)	DC–26.5	53 (21)	≥16	0.31 √f +0.2 (1.8 dB @ f _{max})	<0.06	0.18 (f)
85134F flexible cable set	2.4 mm ³ to PSC-3.5 mm (f) or 3.5 mm (m)	DC–26.5	62.9 (24.75)	≥16	0.31 √f +0.2 (1.8 dB @ f _{max})	<0.12	0.13 (f) +0.5
85135D semi-rigid cable set	2.4 mm ³ to 7 mm	DC–18	53 (21)	≥17	0.31 √f +0.2 (1.5 dB @ f _{max})	<0.06	0.18 (f)
85135F flexible cable set	2.4 mm ³ to 7 mm	DC–18	62.9 (24.75)	≥17	0.31 √f +0.2 (1.5 dB @ f _{max})	<0.12	0.13 (f) +0.5

1. Phase stability of semi-rigid/flexible cables is specified with a 90 degree bend and a 4" radius.

2. Cable length and stability are supplemental characteristics.

3. Special rugged female connector specifically for connecting to the network analyzer test port, but does not mate with a standard male connector.

Related literature

- 5091-8970E** Agilent 8510 Network Analyzer Color Brochure
- 5965-8837E** Agilent 8510 System Solutions
- 5091-8967E** Agilent 8510 Family Network Analyzer Configuration Guide
- 5091-8969E** Agilent 85103 Upgrade Package to the 8510
- 5964-4229E** Agilent 85106D Millimeter-wave Network Analyzer System
Product Overview
- 5091-8965E** Agilent 85108A/L CW/Pulsed Network Analyzer Systems
Product Overview
- 5965-9888E** Agilent 8510XF 110 GHz Single-Sweep Systems
Product Overview
- 5963-3743E** Agilent 85060 Series and 85090 Series Electronic Calibration
Modules and PC Interface



Agilent Email Updates

www.agilent.com/find/emailupdates

Get the latest information on the products and applications you select.



Agilent Email Updates

www.agilent.com/find/emailupdates

Get the latest information on the products and applications you select.



Agilent Direct

www.agilent.com/find/agilentdirect

Quickly choose and use your test equipment solutions with confidence.



www.agilent.com/find/open

Agilent Open simplifies the process of connecting and programming test systems to help engineers design, validate and manufacture electronic products. Agilent offers open connectivity for a broad range of system-ready instruments, open industry software, PC-standard I/O and global support, which are combined to more easily integrate test system development.

www.agilent.com

Agilent Technologies' Test and Measurement Support, Services, and Assistance

Agilent Technologies aims to maximize the value you receive, while minimizing your risk and problems. We strive to ensure that you get the test and measurement capabilities you paid for and obtain the support you need. Our extensive support resources and services can help you choose the right Agilent products for your applications and apply them successfully. Every instrument and system we sell has a global warranty. Two concepts underlie Agilent's overall support policy: "Our Promise" and "Your Advantage."

Our Promise

Our Promise means your Agilent test and measurement equipment will meet its advertised performance and functionality. When you are choosing new equipment, we will help you with product information, including realistic performance specifications and practical recommendations from experienced test engineers. When you receive your new Agilent equipment, we can help verify that it works properly and help with initial product operation.

Your Advantage

Your Advantage means that Agilent offers a wide range of additional expert test and measurement services, which you can purchase according to your unique technical and business needs. Solve problems efficiently and gain a competitive edge by contracting with us for calibration, extra-cost upgrades, out-of-warranty repairs, and onsite education and training, as well as design, system integration, project management, and other professional engineering services. Experienced Agilent engineers and technicians worldwide can help you maximize your productivity, optimize the return on investment of your Agilent instruments and systems, and obtain dependable measurement accuracy for the life of those products.

United States:

(tel) 800 829 4444

(fax) 800 829 4433

Canada:

(tel) 877 894 4414

(fax) 800 746 4866

China:

(tel) 800 810 0189

(fax) 800 820 2816

Europe:

(tel) 31 20 547 2111

Japan:

(tel) (81) 426 56 7832

(fax) (81) 426 56 7840

Korea:

(tel) (080) 769 0800

(fax) (080) 769 0900

Latin America:

(tel) (305) 269 7500

Taiwan:

(tel) 0800 047 866

(fax) 0800 286 331

Other Asia Pacific

Countries:

(tel) (65) 6375 8100

(fax) (65) 6755 0042

Email: tm_ap@agilent.com

Contacts revised: 09/26/05

For more information on Agilent Technologies' products, applications or services, please contact your local Agilent office. The complete list is available at:

www.agilent.com/find/contactus

Product specifications and descriptions in this document subject to change without notice.

© Agilent Technologies, Inc. 2002, 2006

Printed in USA, July 11, 2006

5091-8484E



Agilent Technologies