

Emulation and Analysis Solutions for Hitachi SH7709A/29 Microprocessors

Product Overview
Debug and Integrate
Real-Time Embedded Systems



Logic analysis provides timing and state analysis so you can monitor microprocessor activity in relation to other important system signals such as a PCI bus, other microprocessors, or I/O devices. Traditional emulation systems don't allow you to time-correlate events across your entire system using timing, analog, and state analysis for your most difficult integration problems.

The logic analyzers are nonintrusive, allowing you to run your target system at full speed. A system trace, up to 2M deep, can be combined with complex triggering to find the toughest problems. The microprocessor instruction set execution can be correlated to the high-level source code to help track down problems in your design.

Quickly and accurately determine the root cause of your team's most difficult hardware, software, and system integration problems with Agilent Technologies' powerful emulation and logic analysis solutions.

Agilent's emulation and analysis solution for the Hitachi SH7709A/29 combine the powerful tools of run control, code download, debugger connections, and logic analysis for a complete, scalable system debug environment.

With a scalable solution from Agilent Technologies, your design team members can customize product offerings to meet their unique requirements. Solutions range from emulation probes combined with the industry's leading debuggers to emulation with real-time trace to solve today's most complex SH7709A/29 design problems. Agilent's solutions are designed to meet your needs today and protect your investment as your needs change in the future.



Agilent Technologies

Innovating the HP Way

Agilent Technologies Scalable Solutions

Agilent Technologies emulation and logic analysis solutions are scalable for each member of the digital design team. The following are two typical configurations for firmware/software debug,

hardware debug, and system integration.

Components of these solutions include a logic analyzer, emulation probe/module, analysis

probe, and emulation solution interface software.

Information on each of these components is included in this document.

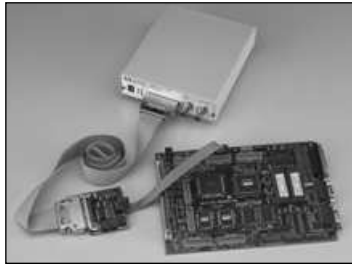

System Features

Run Control with Real-time Execution Trace

- Microprocessor run control on your target system
- Debugger connection

System Components and Functionality

- Emulation Probe:
 - Download code, view and modify memory and view registers on your target system or evaluation board from the debugger interface.
- Emulation Solution Interface Software:
 - C-level run control
- Connection to Industry-Leading Debuggers



Emulation Solution with Real-time Logic Analysis Trace

- Microprocessor run control on your target system
- Debugger connection
- Real-time logic analysis trace solution
 - Assembly & C source level trace
 - Source Correlation

- 16700A Series Logic Analysis System:
 - Capture and analyze code flow and data flow without halting the target system
 - Time correlate analog, timing, and state events across your entire system
 - Monitor microprocessor activity in relation to system buses, other microprocessors, or I/O devices
- Analysis Probe
- Integrated Emulation Module:
 - Download code, view and modify memory and view registers on your target system or evaluation board from the debugger interface
 - Connect to industry-leading debuggers
- Emulation Solution Interface Software:
 - C-level run control
- Bus Trace Interface
- Bus Trigger Interface

Emulation Probe and Module

The emulation probe and module provide the same functionality. The emulation probe is a standalone product, as shown in figure 1. The emulation module is an integrated plug-in for the Agilent Technologies 16700A Series logic analysis systems.

Both the probe and the module help you debug code by providing run control, code download, and memory/register display and modification. You can control program execution through single stepping, start/stop, run/break, and set/modify breakpoints. You can also run code at full speed in the target.

The emulation probe and module can be controlled by an industry-leading debugger, emulation control interface or emulation solution interface software. These interfaces are described on pages 5 and 6.

The emulation probe and module can be controlled over your local area network (LAN) by a debugger and connect to your target through a 14-pin connector or an analysis probe.

Unlike traditional emulators, the emulation probes and modules provide more stable operation by accessing only the debug pins of the microprocessor. You don't need a serial port on your target system to download code. Unlike ROM monitors, they don't require user memory.



Figure 1: Standalone Agilent Technologies Emulation Probe

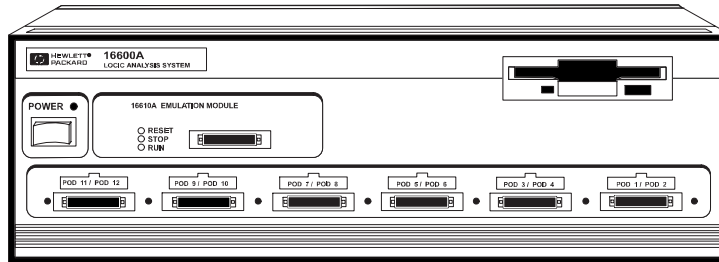

Figure 2: Agilent Technologies 16600A Logic Analysis System with Integrated Emulation Module

Emulation Module Triggering Integration with Logic Analyzer

With the emulation module, use the powerful triggering of the 16700A Series logic analysis systems to halt on events such as microprocessor activity, system buses, or other external events. The emulation module also can trigger the logic analyzer when a breakpoint is hit. This provides powerful event correlation between the debugger interface environment and the logic analyzer.

Analysis Probe

The analysis probe allows easy connection of an Agilent Technologies logic analyzer to your Hitachi SH7709A/29 QFP target system for real-time analysis. With the analysis probe solution, you don't need to design special debug connectors into your target system.

The Hitachi SH7709A/29 analysis probe consists of:

- Analysis probe board
- Configuration files
- Elastomeric probing solution
- Three Agilent E5346A high-density termination adapters
- User's guide

Elastomeric Probing Solution

The elastomeric probing solution included in the analysis probe offers an inexpensive, rugged, and easy-to-use probing solution for the Hitachi SH7709A/29 QFP package. The probes require a minimal "keep out" area around the device, as shown in figure 9.

A retainer is glued to the top of the device, which ensures a solid connection to each pin of the device. Five retainers, a locator tool, and adhesive are included with each probe adapter.

Additional retainers and locator tools can be ordered. Agilent E5374A option 201 offers a kit of five additional retainers and adhesive. An additional locator tool is available as Agilent Technologies E5374A option 202.

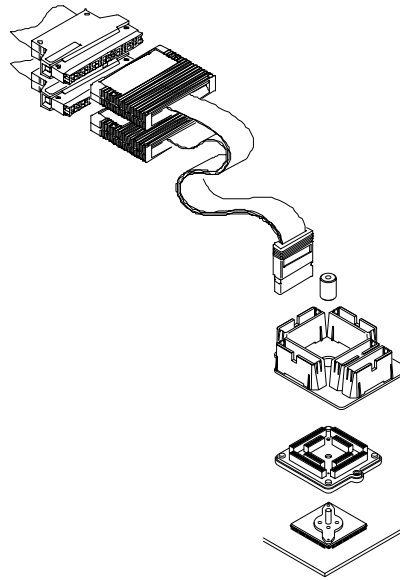

Figure 3: Analysis Probe

Modes of Operation

State-Per-Clock

The logic analyzer records all clock cycles and then the emulation solution interface software analyzes and displays the cycles. The software can also be used to set trigger sequences.

Timing Mode

Timing analysis is supported. All microprocessor signals are presented to the logic analyzer unbuffered.

System Correlation

With the Agilent Technologies logic analysis systems, you can time-correlate bus information from other microprocessors or bus interfaces in your system, such as a PCI bus, with the Hitachi SH7709A/29. Analysis probes are available for additional microprocessors. (Contact your local Agilent Technologies sales office or visit our web site at: <http://www.agilent.com/find/las-data> for more information.)

Optional Mictor Connection Solution

If system constraints won't allow use of the analysis probe, you can design high-density AMP Mictor connectors into your target system for connection to the microprocessor signals. The emulation solution interface software can be ordered separately to provide inverse assembly and configuration files to set up the logic analyzer.

All the necessary signals for inverse assembly can be routed to three Mictor connectors. The AMP Mictor connectors can be located around the microprocessor.

Three Agilent E5346A high-density termination adapters are required for connection to the logic analyzer pods. Mictor connectors can be purchased directly from AMP or from Agilent. Five Mictor connectors and recommended support shrouds are included in the Agilent E5346-68701 Mictor connector kit.

Select Interface Software

There are several different user interfaces available for the Hitachi SH7709A/29 emulation solution. You can connect to industry-leading debuggers, a standard logic analysis emulation control interface or emulation solution interface software.

Debugger Interface

Industry-leading debuggers can control the emulation probe and module. You can set breakpoints, single-step through code, examine variables, and modify source code variables from the high-level source code debugger interface.

Debugger interfaces must be ordered directly from the debugger vendor.

Emulation Control Interface

The emulation module or probe can be controlled directly by the emulation control interface. You can easily display and modify contents of micro-processor registers, system memory, and I/O.

From the run control window you can instruct the microprocessor to run, break, reset, or single-step. You also can choose whether the memory, I/O, and register displays are updated for breaks and single steps.

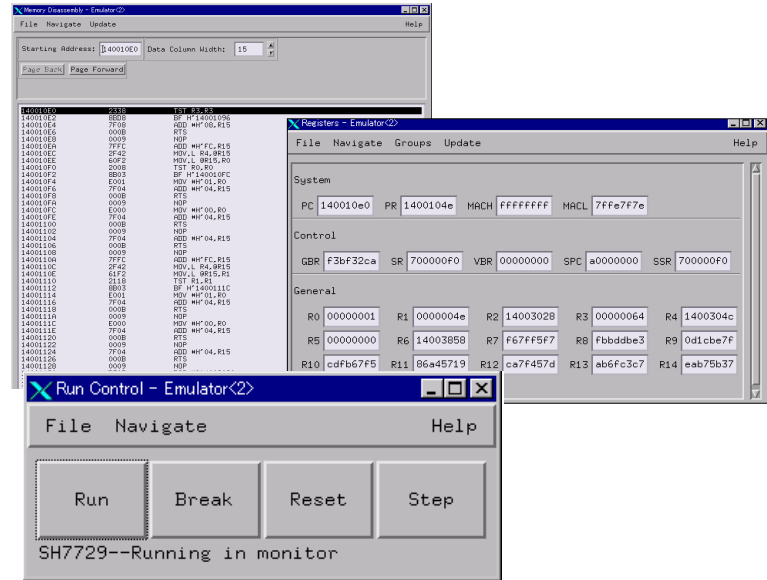

Emulation Solution Interface Software

All the features of the Agilent Technologies emulation and analysis solution are available through one easy-to-use interface -- the Agilent emulation solution interface software.

The emulation solution interface software delivers standard debug features including single stepping through code, setting breakpoints and displaying or modifying memory or registers in your C source code. External bus data or I/O data can be displayed with symbol information. Additionally you can cross trigger external bus data with I/O activity.

The software provides a source-level trace and triggering capability. You can see a complete source-level trace display and can specify any trigger point by pointing to a line in a source window. The interface software can also correlate source code to the trace listing by built-in global markers, making it easy to diagnose hardware/software integration problems.

The interface software supports several kinds of memory systems. These memory systems are directly connected to a dedicated memory controller unit of the Hitachi SH7709A/29. The interface enables you to direct the inverse assembler to capture a variety of memory bus cycles, including DRAM, EDO-DRAM, SDRAM, PCMCIA, Burst-ROM, etc. You can capture and display every kind of memory cycle and bus state with ADDRESS, DATA and STATUS schemes.

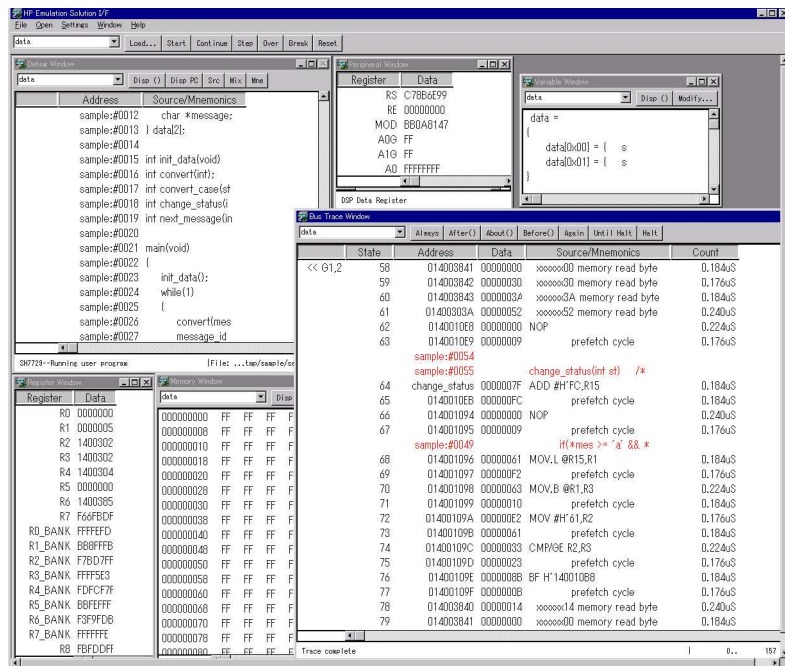

Figure 5: Emulation Interface Software

Pods Required

Six to ten, 16-channel logic analyzer pods are required for inverse assembly. These pods are connected to Agilent E5346A high-density termination adapters included with the analysis probe.

Probe Loading

- 10 pf on all signals
- 100 Kohms on all signals

Agilent Technologies Logic Analyzers Supported

•Contact your Agilent field engineer for latest logic analyzer information.

External Bus Speed	Memory Types Combinations			Required Pods	Minimum Logic Analyzer Supported
	Other than EDO/SDRAM	EDO-DRAM	SDRAM		
>40MHz ²	Yes	No	No	6	16602A 16700/2A + 16550 16700/2A + 16555/6/7 x 2 16700/2A + 16710/1/2
	D.C.	Yes	No	8	16601A 16700/2A + 16550 x 2 16700/2A + 16555/6/7 x 2 16700/2A + 16710/1/2 x 2
	Yes (w/wait cycle) ³	No	Yes	8	16601A 16700/2A + 16550 x 2 16700/2A + 16555/6/7 x 2 16700/2A + 16710/1/2 x 2
	Yes (no-wait cycle)	No	Yes	10	16600A 16700/2A + 16550 x 2 16700/2A + 16555/6/7 x 3 16700/2A + 16710/1/2 x 2
≤40MHz ^{1, 2}	D.C.	D.C.	D.C.	6	16602A 16700/2A + 16550 16700/2A + 16555/6/7 x 2 16700/2A + 16710/1/2

D.C. = Don't Care

¹ Condition of ≤ 40 MHz: CKIO (cycle) = min 25 ns, CKIO (low) = min 10 ns, CKIO (high) = min 10 ns

² If you are using the 16557, an external bus speed threshold would be up to 50 MHz.

Condition of ≤ 50 MHz: CKIO (cycle) = min 20 ns, CKIO (low) = min 7.5 ns, CKIO (high) = min 7.5 ns

Table 1: Logic Analyzers Supported

Language		Version
Hitachi	Compiler	5.0
	Assembler	4.1
	Linker	6.0A
Green Hills		1.8.9

Table 2: Support Languages for Emulation Solution Interface Software

Host Computer	Operating System
HP S-700 Work Station	HP-UX 9.00 or greater
SUN Work Station	Solaris 2.4 or greater
	SUN-OS 4.1.1 or greater
PC	Windows 95 or greater
	Windows NT 4.0 or greater

Table 3: Host Computers Supported by Emulation Solution Interface Software

Emulation Probe and Module Target Connection Information

A connector is needed on the target development board to connect the Hitachi SH7709A/29 microprocessor interface assembly to the debug port of the microprocessor.

	Adapter Type	Part Number
14 pin H-UDI	Vertical mount	3M 2514-6002UB
	Right Angle	3M 2514-5002UB
30 pin AUD	Vertical mount	AMP 104068-3
	Right Angle	AMP 104069-5
36 pin AUD	Screw mount type	Hirose DX10M-36S
	Lock pin mount type	Hirose DX10M-36SE
		Hirose DX10GM-36SE

Table 4: Debug Adapter

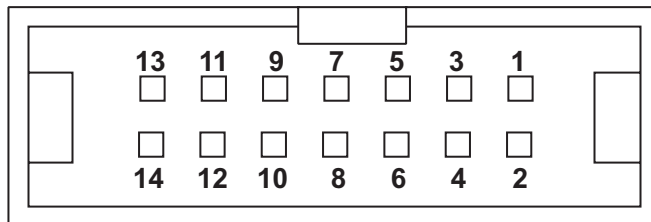

Probe Pin Assign	Signal	SH7709A/29 Pin Number	Probe Pin Assign	Signal	SH7709A/29 Pin Number
1	TCK	88	2	GND	-
3	TRST	60	4	GND	-
5	TDO	87	6	GND	-
7	ASEBRK/BRKACK	86	8	IO VDD	-
9	TMS	85	10	GND	-
11	TDI	84	12	GND	-
13	RESET	83	14	GND	-

Figure 6: 14 Pin H-UDI

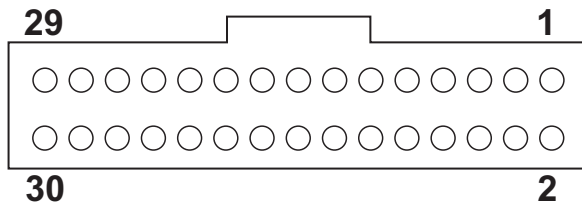

Probe Pin Assign	Signal	SH7709A/29 Pin Number	Probe Pin Assign	Signal	SH7709A/29 Pin Number
1	/RESETP	193	16	GND	-
2	GND	-	17	TDI	138
3	ACDCK	151	18	GND	-
4	GND	-	19	TMS	137
5	AUDATA0	135	20	GND	-
6	GND	-	21	TD0	120
7	AUDATA1	133	22	GND	-
8	GND	-	23	TRST	136
9	AUDATA2	131	24	ASEMD0	127
10	GND	-	25	GND	-
11	AUDATA3	130	26	ASEBRKAK	128
12	GND	-	27	/RST0	-
13	AUDSYNC	94	28	GND	-
14	GND	-	29	VccQ(3.3V)	-
15	TCK	139	30	TRG	-

Figure 7: 30 Pin AUD

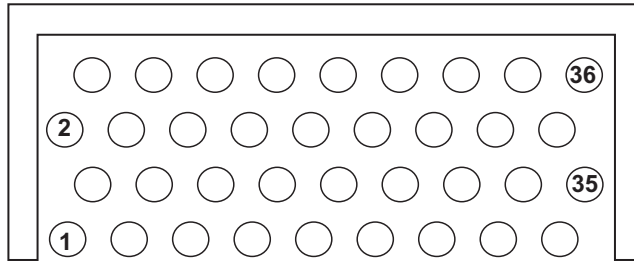

Probe Pin Assign	Signal	SH7709A/29 Pin Number	Probe Pin Assign	Signal	SH7709A/29 Pin Number
1	NC	-	19	TMS	137
2	GND	-	20	GND	-
3	AUDATA0	135	21	/TRST	136
4	GND	-	22	GND	-
5	AUDATA1	133	23	TDI	138
6	GND	-	24	GND	-
7	AUDATA2	131	25	TDO	120
8	GND	-	26	GND	-
9	AUDATA3	130	27	/ASEBRKAK	128
10	GND	-	28	GND	-
11	/AUDSYNC	94	29	VDD	-
12	GND	-	30	GND	-
13	NC	-	31	/RESET	193
14	GND	-	32	GND	-
15	NC	-	33	GND	-
16	GND	-	34	GND	-
17	TCK	139	35	AUDCK	151
18	GND	-	36	GND	-

Figure 8: 36 Pin AUD

Analysis Probe Mechanical Specifications

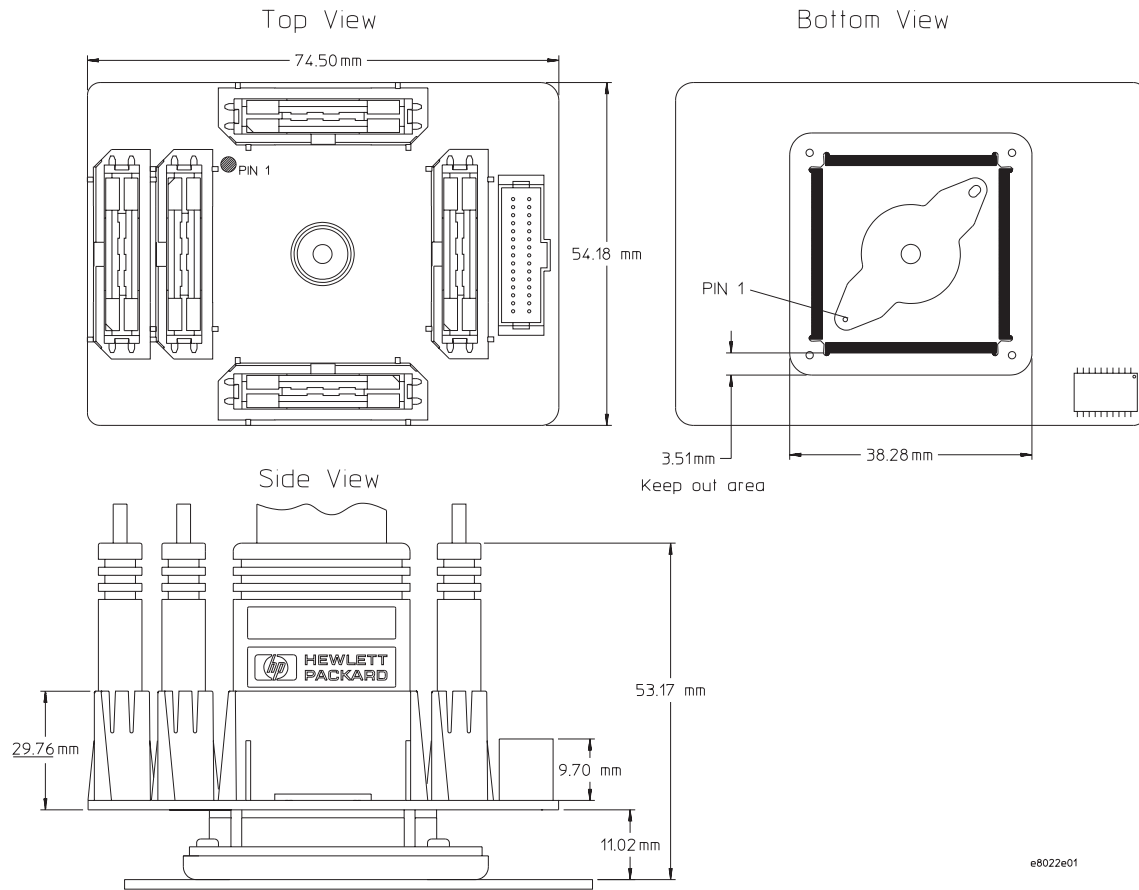

e8022e01

Figure 9: Agilent Technologies E9605A #002 Analysis Probe Dimensions

System Configuration and Ordering Information

The table below shows the system components you need to order and what is included in each. For real-time trace, two alternatives are available to fit your needs.

The solution product numbers do not include logic analysis. The Agilent Technologies 16700A Series logic analysis systems must be ordered separately.

If you want to configure or upgrade your system with individual products, see page 14 for individual product number information.

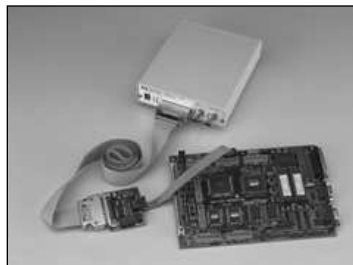

Solution	Products to Order	Included Components
----------	-------------------	---------------------

Run Control with Real-time Execution Trace

- | | | |
|--|---|--|
| <ul style="list-style-type: none"> SH7709A/29 Emulation Probe | <ul style="list-style-type: none"> E5900A #720, B3759A #720 | |
| <ul style="list-style-type: none"> Debugger Connection | <ul style="list-style-type: none"> Order directly from debugger vendor | |



Emulation Solution with Real-time Logic Analysis Trace

- | | | |
|---|---|---|
| <ul style="list-style-type: none"> 16700A Series Logic Analysis System | <ul style="list-style-type: none"> Refer to publication 5966-3107E for logic analyzer configuration Contact your local Agilent field engineer for latest logic analyzer information | |
| <ul style="list-style-type: none"> SH7709A/29 Emulation Solution | <ul style="list-style-type: none"> E5901A #720 B3759A #720 E9605A #002 | <ul style="list-style-type: none"> Emulation Module Emulation Solution Interface Software Analysis Probe Three E5346A High-Density Termination Adapters |
| <ul style="list-style-type: none"> Custom Probing | <ul style="list-style-type: none"> Mictor Solution - HP E5346-68701 Mictor Connector Kit | |
| <ul style="list-style-type: none"> Debugger Connection | <ul style="list-style-type: none"> Debugger Connection - Order directly from Debugger vendor | |



Protecting Your Investment

Agilent Technologies protects your current investment by providing a migration path for the emulation modules and emulation probes as your needs change. To move from one processor family to another, simply order a migration kit for the emulation module or probe, which will provide all the necessary hardware, firmware, and cables to support your new processor family at a fraction of the cost of a new system.

This same migration path works for emulation probes and for emulation modules.

Related Literature	Pub. Number
<i>HP 16600A and 16700A Logic Analysis System Mainframes, Product Overview</i>	5966-3107E
<i>Processor and Bus Support for Agilent Technologies Logic Analyzers, Configuration Guide</i>	5966-4365E
<i>State and Timing Modules for Agilent Technologies Logic Analysis Systems, Product Overview</i>	5966-3367E

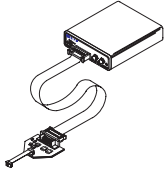
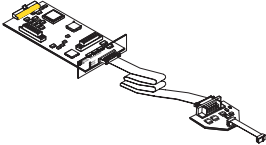
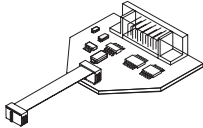
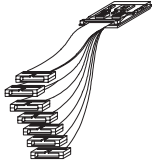
Ordering Information

	<p>E5900A #720</p>	<p>Emulation Probe</p>
	<p>E5901A #720</p>	<p>Emulation Module</p>
	<p>E5902A #720</p>	<p>Emulation Migration</p>
	<p>E9605A #002</p>	<p>Analysis Probe</p>
	<p>B3759A #720</p>	<p>Emulation Solution Interface Software</p>

High-Density Termination Adapter E5346A
Mictor Connector Kit E5346-68701
Five Additional Retainers & Locator Kits E5374A Opt. 201
Additional Locator Tool E5374A Opt. 202

Figure 10: Ordering Information for Individual Components

Agilent Support, Services, and Assistance

Total support for the life of your equipment

Every Agilent instrument and system is backed by a comprehensive set of support policies and services to make sure you get the information and assistance required to use your equipment successfully.

Our Promise:

- Services included at no extra charge
- Practical product recommendations
- Realistic product descriptions
- Functional verification
- Help with basic product operation and advertised capabilities
- Extensive self-help tools
- Global warranties
- Minimum five-year support life

Your Advantage:

- Value-added professional services, when you need them
- Expert professional engineering and consulting services
- Flexible repair and calibration programs
- Software subscriptions and notifications
- Flexible on-site support programs
- Education and training

www.agilent.com

By Internet, phone, fax, or mail, get assistance with all your test & measurement needs

Online

Internet access for Agilent product information, services and support at www.agilent.com/find/tmdir

Internet directory for your local Agilent contacts at www.tm.agilent.com/tmo/assist/English/index.html or www.agilent.com/find/LASystems

Phone and Fax

United States:

Agilent Technologies
(tel) 1 800 452 4844

Canada:

Agilent Technologies Canada Inc.
(tel) 1 877 894 4414

Europe:

Agilent Technologies
Test & Measurement
European Marketing Organisation
(tel) (31 20) 547 2000

Japan:

Agilent Technologies Japan Ltd.
(tel) (81) 426 56 7832
(fax) (81) 426 56 7840

Latin America:

Agilent Technologies
Latin American Region Headquarters, U.S.A.
(tel) (305) 267 4245
(fax) (305) 267 4286

Australia/New Zealand:

Agilent Technologies Australia Pty Ltd
(tel) 1-800 629 485 (Australia)
(fax) (61 3) 9272 0749
(tel) 0 800 738 378 (New Zealand)
(fax) (64 4) 802 6881

Asia Pacific:

Agilent Technologies, Hong Kong
tel: (852)-3197-7777
fax: (852)-2506-9284

Email and Post

Contact your regional Call Center during business hours to get the email and postal address of the Agilent representative whom can best answer your specific test & measurement questions. You can also find the main email and postal addresses for your area (organized by region and then by country) at www.tm.agilent.com/tmo/assist/English/index.html.

Technical and pricing information in this document subject to change without notice.

Copyright © 2000 Agilent Technologies

Printed in USA

5968-6946E 03-00



Agilent Technologies

Innovating the HP Way