

# Complete, PC-compatible, Closed-loop Laser Positioning

Data Sheet

## Laser interferometer increases positioning accuracy

Typical applications for PC-based positioning systems include servo-track writing on high-density disk drives, X-Y stage positioning for IC inspection and repair, and custom test and manufacturing systems. These systems typically have moving platforms that carry the product being fabricated or inspected. The position or movement of the platform determines the characteristics of the end product.

**Agilent 10889B PC Servo-Axis Board**  
**Agilent 10885A PC Axis Board**  
**Agilent 10886A PC Compensation Board**  
**Agilent 10884A Power Supply**

Agilent Technologies offers a complete, versatile laser interferometer positioning system available in PC-compatible format, the most popular industry-standard backplane. Save valuable time and money by quickly and easily integrating Agilent Technologies' lowest-cost laser positioning system into your PC-based equipment.

For complete, closed-loop positioning, use the 10889B PC Servo-Axis Board. For open-loop measurement and for providing position data to custom servo electronics, use the 10885A PC Axis Board. For improved accuracy and repeatability, add the 10886A PC Compensation board to compensate for environmental effects.

Take advantage of the benefits of the lowest cost industry-standard electronics when developing your next precision positioning system:

- Easier, faster development
- Lower development cost and risk
- Reduced hardware cost and complexity
- Smaller size
- Reduced support requirements
- Complete, closed-loop positioning solution
- High accuracy and repeatability from environmental compensation
- High reliability backed by a three-year warranty

A laser interferometer positioning system, when built into these types of equipment, measures the position and allows motion control of the platform with greater accuracy than any other available method.

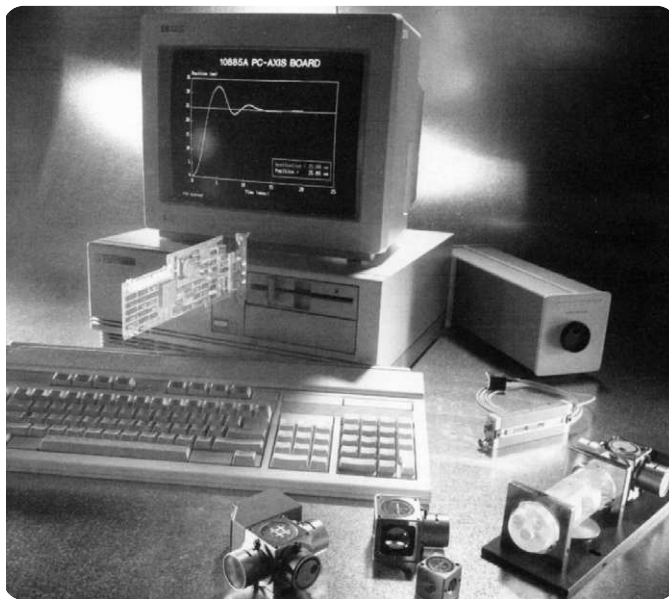

The Agilent 10889B PC Servo-Axis Board, 10885A PC Axis Board, and 10886A PC Compensation Board make it easy to integrate a low-cost laser interferometer into your PC-based system.



**Agilent Technologies**

## Agilent 10889B: powerful, PC-compatible servo capability

### Eliminate the time and expense of custom servo designs

The 10889B PC Servo-Axis Board combines both servo and axis functions to provide a high-performance, closed-loop positioning solution in PC-compatible format. The PC servo-axis board comes with software and design information\* to speed system design and assure a successful positioning solution. Eliminate the time, cost, and risk of designing your own custom positioning system by using the PC servo-axis board.

\* See Application Note 325-10, "Submicron Positioning with the Agilent 5527A Laser Position Transducer System and Agilent 10936A Servo-Axis Board," (5952-7942), which provides design information that also applies to the Agilent 10889B PC Servo-Axis Board.

### Powerful servo capability

The 10889B board provides twice the position resolution of other PC laser electronics and offers a high sample rate for high bandwidth operation. Output of the 10889B board is a  $\pm 10$  V analog motor drive signal; position is also available over the PC backplane and via direct hardware output.

Motion control algorithms are in firmware on the PC servo-axis board, and tuning software and procedures are included. A PID (proportional, integral, differential) filter is included for straightforward positioning problems, and an IIR (infinite impulse response) filter is included for more complex situations. You choose the algorithm that best matches your needs and tune the servo system by programming the motion-control parameters. External, user-defined equations can also be downloaded to the board for maximum flexibility.

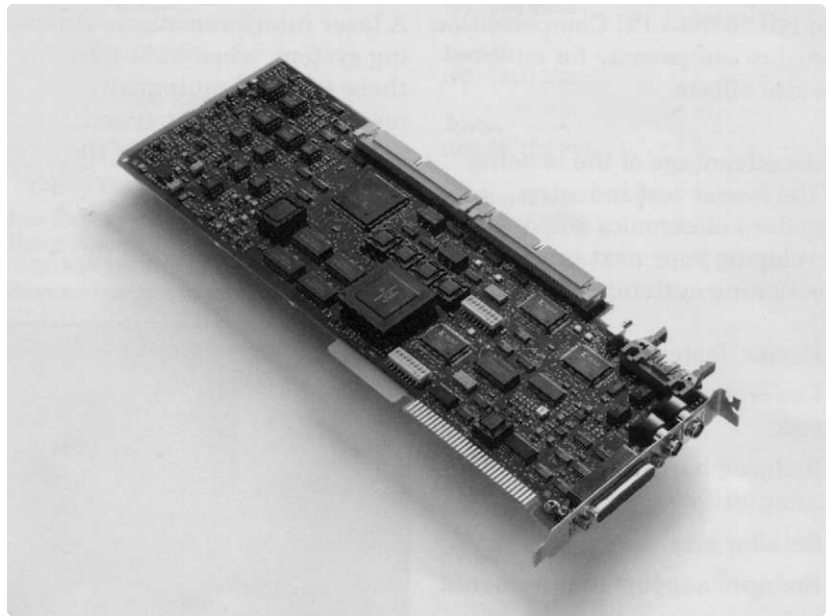

**The Agilent 10889B PC Servo-Axis board eliminates the time, cost, and risk of designing custom servo-electronics for PC-based positioning systems. For compactness and simplicity, the 10889B board combines the servo function and axis function in one convenient package.**

## Versatile performance

The PC servo-axis board provides a wide variety of features so you can tailor system performance to your needs.

With delayed destination capability, destinations can be pipelined to enhance throughput. This allows pre-move profile calculations to be performed while an earlier move is being completed.

The PC servo-axis board includes a programmable settle detect algorithm and a latched out-of-null indication. These features allow you to start an operation once the stage has settled, and detect if the stage has moved out of the null range at any time during the operation.

Position outputs, available via hardware and over the back-plane, provide additional control and flexibility. For example, if position exceeds a predetermined limit, motion can be stopped or fabrication can be suspended. These position outputs can also be used for open-loop operation if desired.

Programmable interrupts are available through selectable interrupt routines which are downloaded to the PC servo-axis board. To maintain the highest performance, interrupts have not been permanently integrated into the PC servo-axis board. Instead, you select the required interrupts from a library of routines, giving you the interrupt control you need without sacrificing system performance.

Up to six PC servo-axis boards can be used in a single, compact system for independent, multiple-axis operation such as simultaneous servo-track writing on multiple drives.

## Improve servo-track writing throughput

Minimize seek and settle times by choosing one of the supplied motion control equations and programming your own coefficients. Different sets of control equation coefficients can be used while writing tracks to deal with system dynamic variations that can degrade seek and settle times over different disk locations. Up to four different sets of coefficients can be stored simultaneously for use during servo-track writing.

You can also save time and improve yields with real-time fault detection. The 10889B's position outputs enable you to quickly detect position wandering outside pre-determined limits during the write process. This could occur from an external disturbance, such as mechanical shock. An out-of-null bit is provided which can be polled in software. Alternatively, if a hardware output is desired, an out-of-window bit is available. If position moves out of the specified range, track-writing can be stopped immediately. When the system is back in position, the affected track can be rewritten correctly. This eliminates tracks written out of position, which saves time and improves yields.

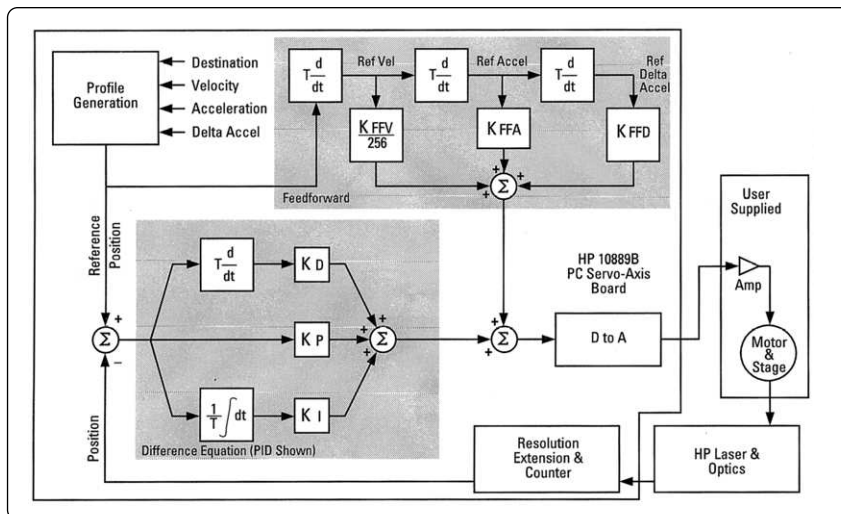

The Agilent 10889B PC Servo-Axis board provides a complete, closed-loop positioning solution for PC-based systems incorporating laser interferometers. The parameters shown are programmed according to the application.

## Agilent 10889B: powerful, PC-compatible servo capability (continued)

### Quickly optimize system performance with trace capability

Speed and simplify tuning using the trace capability to optimize and verify system performance. The Tune program uses trace during profiled moves to display complete profiles of reference position, following error, difference equation output, and motor drive signal. Trace capability allows you to record system performance data during moves and display it for immediate feedback. Quickly understand the effects of your difference equation, coefficients, and feed-forward terms in your system, then easily adjust them to optimize performance.

### Fast startup with tune program

The Tune program provides a front-panel display for the PC servo-axis board for quick tuning of your system using either the PID or IIR difference equation. You simply enter setup parameters and equation coefficients in Tune parameter fields, command moves through menu soft-keys, and view a display of your system's performance. By changing any of these parameters and viewing updated performance profiles, you can quickly tune and verify your system's performance without any prior programming.

In addition, the Tune program easily converts a PID algorithm into an equivalent IIR algorithm if required. This could be important if the mechanism has resonances that cannot reasonably be eliminated by mechanical adjustments, and notch filters are required to stabilize system performance.

### For your special needs

Continuous product development is underway to enhance system performance and capabil-

ity. Quick turn-around enhancements may include customized difference equations and specialized PC servo-axis processing routines. Contact your Agilent Technologies sales representative (see back cover for sales office listings) if you need features not presently included in the 10889B PC Servo-Axis Board. If an upgrade that meets your special needs is not already available, one may be developed for you.

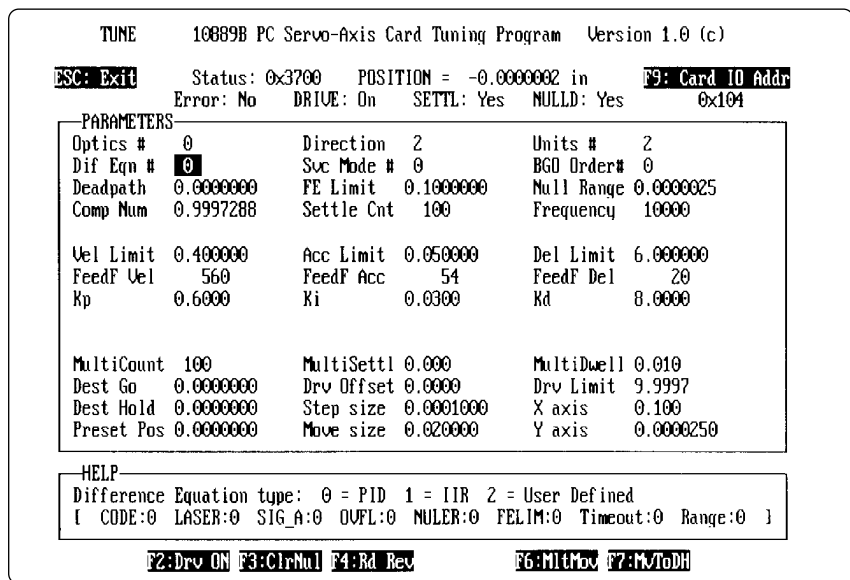

The Tune program provides a front panel display for quick system tuning without programming.

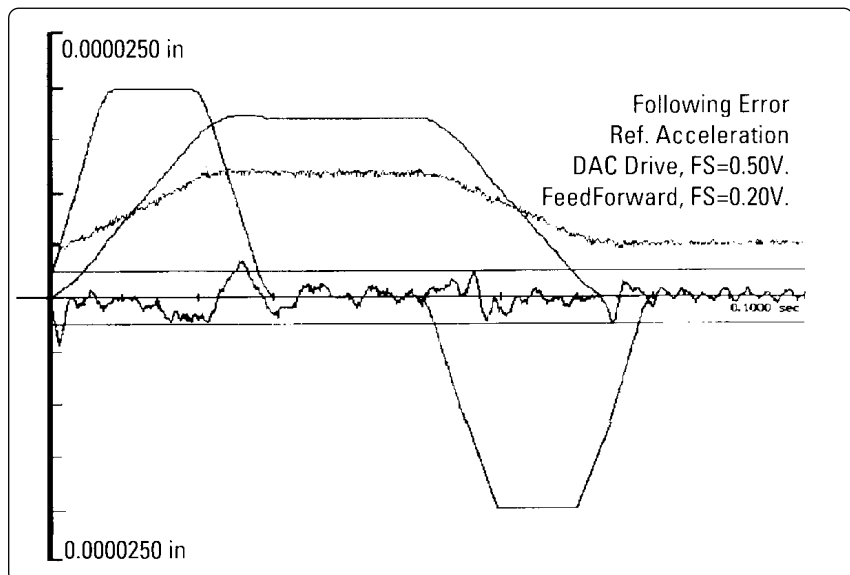

The Tune program display of servo position error speeds tuning by providing immediate performance feedback.

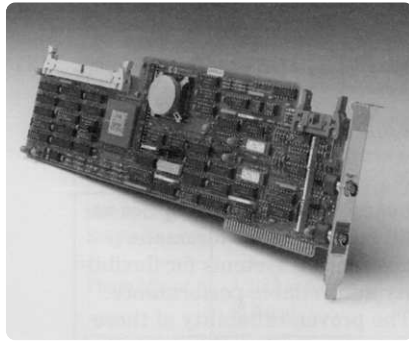

Reduce your system's size, cost, and complexity with the 10885A PC Axis Board.

## Agilent 10885A and 10886A: More choices to optimize your measurement system

### PC axis board provides fast, easy data access

The 10885A is a register-programmed position interferometer which provides a 32-bit position word\* that is readable over the PC backplane and is also available from a real-time hardware output. This makes it well-suited for open-loop measurements and for providing position data for custom closed-loop servo electronics.

The PC Axis Board also provides the ease of programming you expect from the DOS environment, saving valuable development time. Eight-bit bus transfers are used for compatibility with standard software programs. In addition, a set of programs is included on 3 1/2" diskette for fast setup and data gathering.

\* The position word is in fractions of a wave length, not English or metric units.

## PC compensation electronics increase system accuracy and repeatability

The 10886A PC Compensation Board is used with the 10885A PC Axis Board and 10889B PC Servo-Axis Board to improve the quality of manufactured parts. The compensation board with environmental sensors increases the accuracy and repeatability of the laser interferometer positioning system by compensating for changes in the system's operating environment.

Every laser interferometer measurement depends on the wavelength-of-light (WOL) as its basic scale length. Changes in air temperature, pressure, and humidity change the air's index of refraction, which in turn changes the WOL in air. The 10886A board is used with the 10751C/D Air Sensor to measure these environmental changes so the resulting errors can be compensated to provide a system accuracy up to  $\pm 1.5$  ppm.

In addition to WOL considerations, measurement errors can also result from thermal expansion of the workpiece or machine being measured. Up to three 10757D/E/F Material Temperature Sensors can be used with the 10886A board to measure material temperature so thermal expansion errors can be compensated.

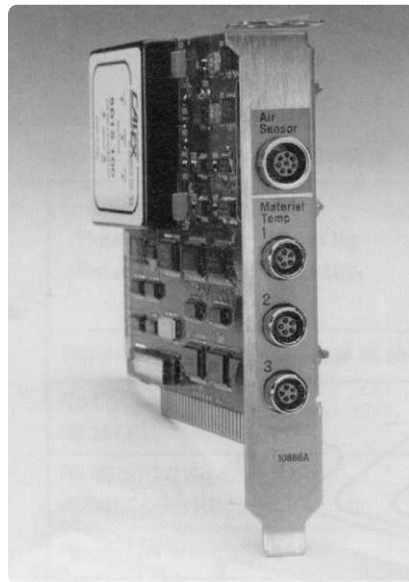

Improve your system's accuracy and repeatability with environmental compensation using the 10886A PC Compensation Board.



The 10757D/E/F Material Temperature Sensor monitors the temperature of the object being measured for automatic compensation for thermal expansion.

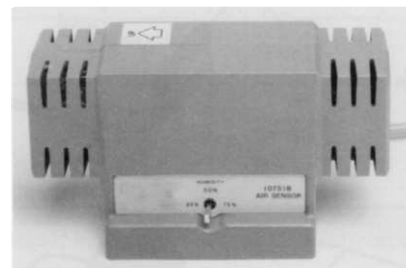

The 10751 C/D Air Sensor measures air temperature and pressure for automatic wavelength-of-light compensation.

# PC-based laser system configuration guide

## PC-based laser system configurations

The sketch shows a typical single-axis configuration for a PC-based laser interferometer positioning system.

Normally a single compensation board is used to compensate an entire multi-axis system. For applications with special compensation needs, such as several very long axes, a separate compensation board and air sensor can be used to compensate each axis individually.

For complete information about the laser heads, optics, sensors, and cables available for PC-based systems, including dimensions, see the *Ordering Information*, publication number 5091-7651E and the *Optics and Laser Heads data sheet*, publication number 5091-0728E.

## Typical configuration for servo-track writer

(Uncompensated, single-axis, closed-loop system)

- 10889B PC Servo-Axis Board
- 5517C Laser Head
- 10881A Laser Head Cable
- 10884A Power Supply
- 10780C Receiver
- 10880A Receiver Cable
- 10705A Single Beam Interferometer
- 10704A Retroreflector\*

\* For applications sensitive to retroreflector weight, bare cube corners are available:  
10713C  
0.5 in (12.7 mm) Cube Corner  
10713D  
0.25 in (6.3 mm) Cube Corner

## Proven reliability

All PC electronics are warranted for three years and use the same proven laser heads, receivers, and optics as all Agilent laser interferometer positioning systems for flexibility and reliable performance. The proven reliability of these components, together with their traditional Agilent Technologies quality, service, and support, ensure system durability and reduce support cost and risk.

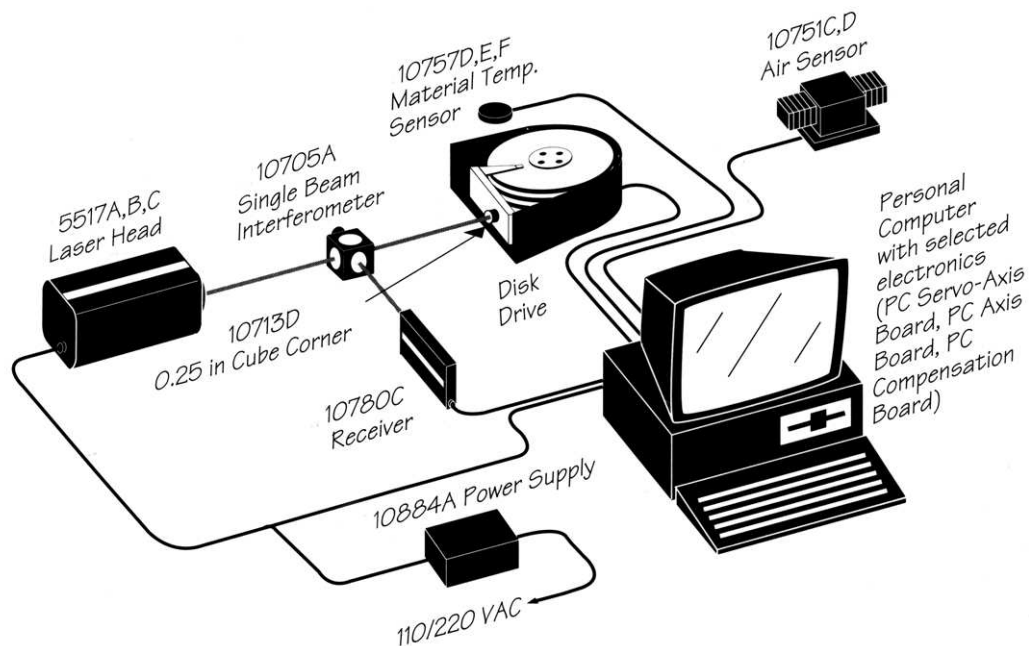

Modular design of the PC-compatible laser interferometer positioning system gives you maximum flexibility. Disk drive servo-track writer is shown.

# System specifications

## System performance

Optics	Resolution		Maximum velocity			
	10885A	1088913*	Range**	5517A Laser head	5517B Laser head	5517C Laser head
Linear or single beam	$\lambda/64$ or 10.0 nm (0.4 $\mu\text{m}$ )	$\lambda/128$ or 5 nm (0.2 $\mu\text{m}$ )	$\pm 10.6$ m (34.8 ft)	406 mm/s (16 in/s)	508 mm/s (20 in/s)	711 mm/s (28 in/s)
Plane mirror	$\lambda/128$ or 5.0 nm (0.2 $\mu\text{m}$ )	$\lambda/256$ or 2.5 nm (0.1 $\mu\text{m}$ )	$\pm 5.3$ m (17.4 ft)	203 mm/s (8 in/s)	254 mm/s (10 in/s)	356 mm/s (14 in/s)
High resolution	$\lambda/256$ or 2.5 nm (0.1 $\mu\text{m}$ )	$\lambda/512$ or 1.2 nm (0.05 $\mu\text{m}$ )	$\pm 2.65$ m (8.7 ft)	102 mm/s (4 in/s)	127 mm/s (5 in/s)	178 mm/s (7 in/s)

\* Applies to both open and closed-loop operation.

\*\* The range shown is the limit before the position counter overflows.  
The range may be extended by monitoring the number of overflows.

## System measurement accuracy

Environment: Pressure: 760 mm + 25mm Hg Relative humidity: 50% $\pm$ 10%	Measurement accuracy*		
Temperature: 20° C plus range as shown	$\pm 0.1^\circ$ C	$\pm 1.0^\circ$ C	$\pm 5.0^\circ$ C
No compensation** (@ 20° C)	$\pm 9.0$ ppm	$\pm 9.9$ ppm	$\pm 14.0$ ppm
10751C/D Air sensor (@ 20° C) and 10886A	$\pm 1.5$ ppm	$\pm 1.6$ ppm (typical)	$\pm 1.7$ ppm
10717A Wavelength tracking compensation***	$\pm 0.15$ ppm	$\pm 0.19$ ppm	$\pm 0.44$ ppm
Measurement in vacuum	$\pm 0.1$ ppm	$\pm 0.1$ ppm	$\pm 0.1$ ppm
Measurement in vacuum with Factory calibration of laser head to MIL STD 45662	$\pm 0.02$ ppm	$\pm 0.02$ ppm	$\pm 0.02$ ppm

\* These accuracy specifications include the laser head term, but exclude electronics accuracy and interferometer nonlinearity terms.

\*\* No compensation means that no correction in compensation number occurs during environmental changes.

\*\*\* System accuracy equals these values (measurement repeatability) for a calibrated laser head plus accuracy of initial compensation value.  
Use of the 10717A requires its own 10885A PC Axis Board and 10780C Receiver.

# Specifications

## Agilent 10889B PC servo-axis board

### Motor drive outputs

$\pm 10$  V analog (DAC OUT and AGND):

Resolution: 0.305 mV

Output updated at sample rate

Programmable limit (centered on 0 volts)

### Programmable control

Selectable difference equation:

PID (Proportional, Integral, Difference)

IIR (Infinite Impulse Response), 2nd order

User-modifiable downloadable equations (requires assembly language programming)

Consult your Agilent Technologies' sales representative for further customized equations and firmware routines available

Programmable sample rate:

250 Hz to 20 kHz (depending on equation used)

Programmable difference equation coefficients:

3 coefficients for PID

5 coefficients for IIR

Programmable feedforward terms:

Feedforward velocity

Feedforward acceleration

Feedforward delta acceleration

Profiling Modes:

Internal and external position profiling

Internal and external velocity profiling

Buffered position profiling (Linear Interpolation available)

Programmable profile limit terms

Position profiling (velocity, acceleration, and delta acceleration)

Velocity profiling (acceleration and delta acceleration)

Programmable trace function:

Buffer size: 32k longwords

Data size:

Reference position, actual position: one longword  
Difference equation output, drive signal output: half longword

(Position error can be displayed from reference position minus actual position)

### Included software tools

Tune Program

Demo Programs

Library of C Functions\*

User Downloadable Routines\*

\* Contact your Agilent Technologies' sales representative for C Function Libraries and Downloadable Routines.

### Hardware position output

(Uses PC internal ribbon cable connector)

Binary units: Fractions of a wavelength, 2's complement

Data update rate: 10 MHz for all laser heads

Data age: Typical 1.2  $\mu$ s fixed  
< 1 ns ambiguity for constant ambient temperature  
< 10 ns ambiguity over a temperature range of 0–55° C

Assumes sampling is synchronized to the 10 MHz clock

Least significant bit (one count) equals resolution /4

### PC backplane position output

Binary units: Fractions of a wavelength, English or metric  
Least significant bit (one count) equals resolution

Data update rate: (typical, varies according to board configuration and PC performance)

Units	386/25 PC	486SX/25 PC
Inches or metric	7 kHz	8 kHz
Raw, uncompensated counts	10 kHz	12 kHz

Note: Custom downloadable software may significantly improve these data rates. Contact your Agilent Technologies' sales representative for details.

### ISA compatibility

10889B is a standard AT-size board which supports 8-bit bus transfers

### Power requirements (typical)

5 Vdc +0.25 V/0.125 V at 3.0 A  
+12V  $\pm 0.5$  Vdc at 0.15 A  
–12V  $\pm 0.5$  Vdc at 0.05 A

### Cables

Agilent 10880A/B/C Receiver cable

Agilent 10881A/B/C/D/E/F Laser head cable

### Weight

0.45 kg (1 lb)

### Operating temperature

0–40° C (32–104° F)

# Agilent 10885A PC axis board

## PC backplane position output

### *Data format*

Units: fractions of a wavelength  
32 bits (4 bytes)  
2's Complement  
Positive logic least significant bit (one count) equals resolution

### *Typical data update rate over backplane (Compiled quick basic program)*

80286 @ 8 MHz: 58 kHz  
80386 @ 25 MHz: 74 kHz  
80486 @ 25 MHz: 105 kHz

### *Data age and sample ambiguity*

After a sample operation, the value in the position register will reflect an actual position that occurred 0.1 to 1.4  $\mu$ s before the sample operation was initiated.

### *Sample delay*

The position register may be read 1.5  $\mu$ s after a sample operation.

## Connector position output

### *Data format*

Units: fractions of a wavelength  
2's Complement  
32-bit parallel binary  
Positive logic  
Least significant bit (one count) equals resolution

### *Data update rate*

5517A: 1.5–2.0 MHz  
5517B: 1.9–2.4 MHz  
5517C: 2.4–3.0 MHz  
(Hardware included to synchronize to slower clocks)

### *Data Age*

5517A: 2.1–4.1  $\mu$ s  
5517B: 1.8–3.3  $\mu$ s  
5517C: 1.5–2.7  $\mu$ s

Data Age is dependent on the laser head reference signal (split-frequency) and on knowing exactly when, in relation to the rising edge of the Error Clock, the Position Error lines are sampled – call this time  $\Delta T$ .

$$\text{Data Age} = 0.34 \mu\text{s} + \Delta T \mu\text{s} + \frac{4.0 \pm 0.5}{\text{Reference (in MHz)}} \mu\text{s}$$

Additionally, the Data Age may vary up to 0.1  $\mu$ s typically and up to 0.25  $\mu$ s in a worst case situation as a result of the Reference frequency varying over time.

## Power requirements (typical)

5 Vdc at 1.6 A  
 $\pm 12$  Vdc at 0.015 A

## Weight

0.30 kg (0.65 lb)

## Operating temperature

0–40°C (32–104°F)

## ISA compatibility

Standard XT-size board which supports 8-bit bus transfers

## Cables

10880A/B/C Receiver Cable  
10881A/B/C/D/E/F Laser Head Cable

## Specifications (continued)

### Agilent 10884A power supply

Up to six axes may be used with a single laser head. If the power supply can be adjusted to provide more than 15V, all six axes can use any length receiver cable. However, if a fixed 15V power supply (such as the 10884A) is used, voltage drop over the cables limits the number of axes. Using medium length cables, a maximum to two axes is recommended. Using long cables, a maximum of two axes is recommended.



The 10884A Power Supply provides power to the 5517A/B/C Laser Head and 10780C/F Receivers.

#### Input

100–240 Vac, 50/60 Hz,  
0.8–50.40 A, 60W

#### Output

+5 Vdc at 3.0 A  
+15 Vdc at 2.0 A  
–15 Vdc at 0.35 A

#### Weight

0.84 kg (1.84 lb)

#### Operating temperature

0–40° C (32–104° F)

## Cable specifications

### Agilent 10880A/B/C receiver cable

**Use:** Connects 10780C/F Receiver to 10885A and 10889B electronics

#### Lengths

10880A: 5 in (16.4 ft)  
10880B: 10 in (32.8 ft)  
10880C: 20 in (65.6 ft)

### Agilent 10881A/B/C/D/E/F laser head cable\*

**Use:** Connects 5517A/B/C Laser Head to 10885A and 10889A electronics

#### Lengths

10881A: 3 in (9.8 ft)  
10881B: 7 in (23.0 ft)  
10881C: 20 in (65.6 ft)  
10881D: 3 in (9.8 ft.)  
10881E: 7 in (23.0 ft.)  
10881F: 20 in (65.6 ft.)

\* Note: 10881A/B/C has a DIN connector to connect to 10884A Power Supply. 10881D/E/F has a spade lug connector.

### Agilent 10886A PC compensation board†

**Compensation update rate**  
0.5 Hz (maximum)

#### Power requirements (typical)

5 Vdc at 1.0 A with all four sensors connected

#### Weight

0.18 kg (0.40 lb)

#### Operating temperature

0–40° C (32–104° F)

#### ISA compatibility

Half XT-size board which supports 8-bit bus transfers

† System measurement accuracy is given in table on page 7.

## Environmental sensor specifications

The environmental sensors are used with the 10886A PC Compensation Board. The 10751C/D Air Sensor measures air temperature and pressure. The 10757D/E/F Material Temperature Sensor monitors the temperature of an object being measured or of the machine itself.

## Agilent 10757D/E/F material temperature sensor

### Weight

10757D: 255 g (9 oz)  
10757E: 525 g (19 oz)  
10757F: 795 g (28 oz)

### Cable lengths

10757D: 5 m (16 ft)  
10757E: 15 m (49 ft)  
10757F: 25 m (82 ft)

### Power requirements (typical)

+15 V at 7 mA  
-15 V at 7 mA

### Heat dissipation

0.2 W typical

### Calibration interval

12 months

### Operating range 0–40° C

### Accuracy (0–40° C)

±0.35° C  
±0.10° C with 12-month calibration interval

### Time constant 40 s typical

## Agilent 10751C/D air sensor

### Weight

10751C: 840 g (30 oz)  
10751D: 1500 g (53 oz)

### Cable lengths

10751C: 5 m (16 ft)  
10751D: 15 m (49 ft)

### Power requirements (typical)

+15 V at 53 mA  
-15 V at 53 mA

### Heat dissipation

2 W typical

### Calibration interval

12 months

### Operating range

Temperature: 0–40° C  
Absolute pressure:  
517.2–775.7 mm Hg  
(10–15 psia)

### Accuracy

19.5–20.5° C: 1.4 ppm  
15–25° C: 1.6 ppm  
0–40° C: 2.9 ppm

### Time constant

Temperature: 7 min typical  
Pressure: 2 s typical

**Agilent Technologies' Test and Measurement Support, Services, and Assistance**

Agilent Technologies aims to maximize the value you receive, while minimizing your risk and problems. We strive to ensure that you get the test and measurement capabilities you paid for and obtain the support you need. Our extensive support resources and services can help you choose the right Agilent products for your applications and apply them successfully. Every instrument and system we sell has a global warranty. Support is available for at least five years beyond the production life of the product. Two concepts underlie Agilent's overall support policy: "Our Promise" and "Your Advantage."

**Our Promise**

Our Promise means your Agilent test and measurement equipment will meet its advertised performance and functionality. When you are choosing new equipment, we will help you with product information, including realistic performance specifications and practical recommendations from experienced test engineers. When you use Agilent equipment, we can verify that it works properly, help with product operation, and provide basic measurement assistance for the use of specified capabilities, at no extra cost upon request. Many self-help tools are available.

**Your Advantage**

Your Advantage means that Agilent offers a wide range of additional expert test and measurement services, which you can purchase according to your unique technical and business needs. Solve problems efficiently and gain a competitive edge by contracting with us for calibration, extra-cost upgrades, out-of-warranty repairs, and on-site education and training, as well as design, system integration, project management, and other professional engineering services. Experienced Agilent engineers and technicians worldwide can help you maximize your productivity, optimize the return on investment of your Agilent instruments and systems, and obtain dependable measurement accuracy for the life of those products.

**By internet, phone, or fax, get assistance with all your test & measurement needs**

**Online assistance:**  
[www.agilent.com/find/assist](http://www.agilent.com/find/assist)

**Phone or Fax  
United States:**  
(tel) 1 800 452 4844

**Canada:**  
(tel) 1 877 894 4414  
(fax) (905) 282-6495

**Europe:**  
(tel) (31 20) 547 2323  
(fax) (31 20) 547 2390

**Japan:**  
(tel) (81) 426 56 7832  
(fax) (81) 426 56 7840

**Latin America:**  
(tel) (305) 269 7500  
(fax) (305) 269 7599

**Australia:**  
(tel) 1 800 629 485  
(fax) (61 3) 9210 5947

**New Zealand:**  
(tel) 0 800 738 378  
(fax) 64 4 495 8950

**Asia Pacific:**  
(tel) (852) 3197 7777  
(fax) (852) 2506 9284

**Product specifications and descriptions in this document subject to change without notice.**

**Copyright © 2001  
Agilent Technologies  
Printed in USA March 21, 2001  
5091-8435E**



**Agilent Technologies**