

# Agilent 2-Port PNA-L Microwave Network Analyzer

**Please note:** This document *does not* contain Agilent's most up-to-date PNA-L network analyzer portfolio. This document is available for reference only for customers using Agilent's legacy network analyzers. To view the current Agilent 2-port PNA-L Microwave Network Analyzer Data Sheet [click here](#).

**N5230A**  
**300 kHz to 6, 13.5 GHz**  
**10 MHz to 20, 40, 50 GHz**  
Data Sheet

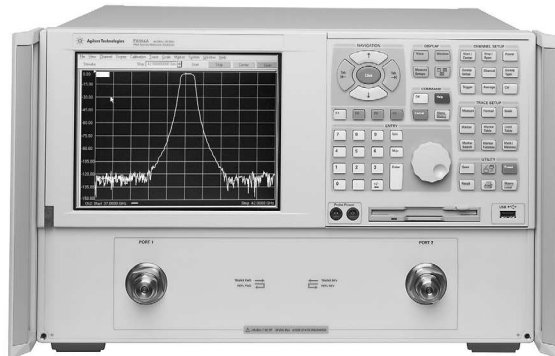
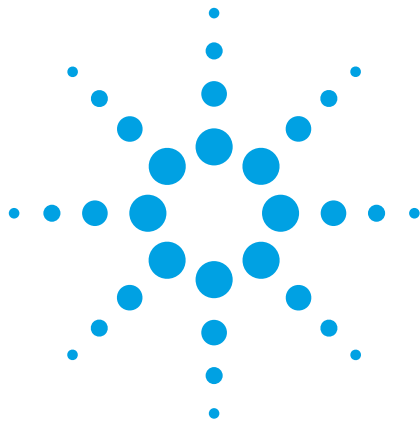

**Note:**  
Specification information in this document is also available within the PNA-L network analyzer's internal Help system.

# Table of Contents

|  |           |
|--|-----------|
| <b>Definitions</b> .....   | <b>3</b>  |
| <b>Corrected System Performance</b> .....  | <b>4</b>  |
| Table 1. System dynamic range .....  | 4         |
| Table 2. Extended dynamic range .....  | 5         |
| N5230A Corrected system performance with 3.5mm connectors .....  | 6         |
| Table 3. 85052B Calibration kit N5230A –<br>Configuration test set and extended power range (Option 025 or 125) ..                     | 6         |
| Table 4. 85052B Calibration kit N5230A –<br>Configuration test set and extended power range (Option 225) .....                         | 8         |
| Table 5. N4691A Electronic calibration module N5230A –<br>Configuration test set and extended power range (Option 225) .....           | 10        |
| Table 6. 85056A Calibration kit N5230A –<br>Configuration test set and extended power range<br>(Option 425 or 525) .....               | 12        |
| Table 7. N4693A Electronic calibration module N5230A –<br>Configuration test set and extended power range<br>(Option 425 or 525) ..... | 14        |
| N5230A Corrected system performance with Type-N connectors .....   | 16        |
| Table 8. N5232B Calibration kit N5230A –<br>Configuration test set and extended power range (Option 025) .....                         | 16        |
| Table 9. Uncorrected system performance .....  | 18        |
| Table 10. Test port output .....   | 19        |
| Table 11. Test port input .....  | 21        |
| <b>Dynamic Accuracy</b> .....  | <b>25</b> |
| Table 12. Test port input (group delay) .....  | 25        |
| <b>General Information</b> .....   | <b>26</b> |
| Table 13. Miscellaneous information .....  | 26        |
| Table 14. Front panel information .....  | 26        |
| Table 15. Rear panel information .....   | 27        |
| Table 16. Analyzer environment and dimensions .....  | 28        |
| <b>Measurement Throughput Summary</b> .....  | <b>29</b> |
| Table 17. Typical cycle time (ms) for measurement completion .....   | 29        |
| Table 18. Cycle time vs IF bandwidth (Options 020, 025, 120, 125) .....  | 30        |
| Table 19. Cycle time vs IF bandwidth (Options 220, 225, 420, 425) .....  | 31        |
| Table 20. Cycle time vs number of points (Options 020, 025, 120, 125) .....  | 32        |
| Table 21. Cycle time vs number of points<br>(Options 220, 225, 420, 425, 520, 525) .....   | 33        |
| Table 22. Data transfer time (ms) .....  | 34        |
| <b>Specifications: Front-Panel Jumpers</b> .....   | <b>35</b> |
| Table 23. Measurement receiver inputs (Rcvr A In, Rcvr B In) .....   | 35        |
| Table 24. Reference receiver inputs (Rcvr R1, Rcvr R2) .....   | 36        |
| Table 25. Reference outputs (Reference 1 Source out,<br>Reference 2 Source Out) .....  | 36        |
| Table 26. Source outputs (Port 1 source out, Port 2 Source Out) .....  | 37        |
| Table 27. Coupler inputs (port 1 Cplr Thru, Port 2 Cplr Thru) .....  | 37        |
| Table 28. Coupler outputs (port 1 Cplr Arm, Port 2 Cplr Arm) .....   | 37        |
| <b>Test Set Block Diagrams</b> .....   | <b>38</b> |
| N5230A Option 220, or 420, or 520<br>(standard test set and standard power range) network analyzer .....                               | 38        |
| N5230A Option 225, or 425, or 525<br>(configurable test set and extended power range) network analyzer .....                           | 38        |
| <b>Web Resources</b> .....   | <b>39</b> |

---

This is a subset of technical specifications for the N5230A network analyzer.

To view or print the N5230A technical specifications, visit our web site at [www.agilent.com/find/pnal](http://www.agilent.com/find/pnal)

This N5230A document provides technical specifications for the following calibration kits and ECal modules only: 85052B, 85056A, 85032B, N4691A, and N4693A. Please download our free Uncertainty Calculator from [www.agilent.com/find/na\\_calculator](http://www.agilent.com/find/na_calculator) to generate the curves for your calibration kit and PNA setup.

---

## Definitions

All specifications and characteristics apply over a 25 °C  $\pm$ 5 °C range (unless otherwise stated) and 90 minutes after the instrument has been turned on.

**Specification (spec.):** Warranted performance. Specifications include guardbands to account for the expected statistical performance distribution, measurement uncertainties, and changes in performance due to environmental conditions.

**Characteristic (char.):** A performance parameter that the product is expected to meet before it leaves the factory, but that is not verified in the field and is not covered by the product warranty. A characteristic includes the same guardbands as a specification.

**Typical (typ.):** Expected performance of an average unit which does not include guardbands. It is not covered by the product warranty.

**Nominal (nom.):** A general, descriptive term that does not imply a level of performance. It is not covered by the product warranty.

**Calibration:** The process of measuring known standards to characterize a network analyzer's systematic (repeatable) errors.

**Corrected (residual):** Indicates performance after error correction (calibration). It is determined by the quality of calibration standards and how well "known" they are, plus system repeatability, stability, and noise.

**Uncorrected (raw):** Indicates instrument performance without error correction. The uncorrected performance affects the stability of a calibration.

**Standard:** When referring to the analyzer, this includes no options unless noted otherwise.

## Corrected System Performance

The specifications in this section apply for measurements made with the N5230A analyzer with the following conditions:

- 10 Hz IF bandwidth
- No averaging applied to data
- Isolation calibration with an averaging factor of 8

**Table 1. System dynamic range<sup>1</sup>**

### Standard configuration and standard power range

| Description                   | Specification (dB)<br>at test port |               |               |               | Typical (dB)<br>at test port |               |               |               |
|-------------------------------|------------------------------------|---------------|---------------|---------------|------------------------------|---------------|---------------|---------------|
|                               | Option<br>020, 120                 | Option<br>220 | Option<br>420 | Option<br>520 | Option<br>020, 120           | Option<br>220 | Option<br>420 | Option<br>520 |
| 300 kHz to 3 MHz <sup>3</sup> | 93 <sup>4</sup>                    |               |               |               |                              |               |               |               |
| 3 to 10 MHz                   | 113                                |               |               |               |                              |               |               |               |
| 10 to 45 MHz                  | 122                                |               |               |               | 103                          | 89            | 89            |               |
| 45 to 70 MHz <sup>2</sup>     | 122                                | 101           | 90            | 90            |                              |               |               |               |
| 70 to 500 MHz <sup>2</sup>    | 122                                | 105           | 90            | 90            |                              |               |               |               |
| 500 MHz to 2 GHz              | 122                                | 110           | 110           | 110           |                              |               |               |               |
| 2 to 6 GHz                    | 122                                | 110           | 110           | 110           |                              |               |               |               |
| 6 to 8 GHz                    | 120                                | 110           | 110           | 110           |                              |               |               |               |
| 8 to 9 GHz                    | 120                                | 110           | 100           | 100           |                              |               |               |               |
| 9 to 10.5 GHz                 | 116                                | 110           | 100           | 100           |                              |               |               |               |
| 10.5 to 12.5 GHz              | 111                                | 110           | 100           | 100           |                              |               |               |               |
| 12.5 to 13.5 GHz              | 109                                | 108           | 100           | 100           |                              |               |               |               |
| 13.5 to 20 GHz                |                                    | 108           | 100           | 100           |                              |               |               |               |
| 20 to 31.25 GHz               |                                    |               | 95            | 95            |                              |               |               |               |
| 31.25 to 40 GHz               |                                    |               | 90            | 90            |                              |               |               |               |
| 40 to 50 GHz                  |                                    |               |               | 79            |                              |               |               |               |

### Configurable test set and extended power range

| Description                   | Specification (dB)<br>at test port |               |               |               | Typical (dB)<br>at test port |               |               |               |
|-------------------------------|------------------------------------|---------------|---------------|---------------|------------------------------|---------------|---------------|---------------|
|                               | Option<br>025, 125                 | Option<br>225 | Option<br>425 | Option<br>525 | Option<br>025, 125           | Option<br>225 | Option<br>425 | Option<br>525 |
| 300 kHz to 3 MHz <sup>3</sup> | 92 <sup>4</sup>                    |               |               |               |                              |               |               |               |
| 3 to 10 MHz                   | 112                                |               |               |               |                              |               |               |               |
| 10 to 45 MHz                  | 121                                |               |               |               | 103                          | 88            | 88            |               |
| 45 to 70 MHz <sup>2</sup>     | 121                                | 101           | 90            | 90            |                              |               |               |               |
| 70 to 500 MHz <sup>2</sup>    | 121                                | 105           | 90            | 90            |                              |               |               |               |
| 500 MHz to 2 GHz              | 121                                | 110           | 110           | 110           |                              |               |               |               |
| 2 to 6 GHz                    | 121                                | 110           | 110           | 110           |                              |               |               |               |
| 6 to 8 GHz                    | 120                                | 110           | 110           | 110           |                              |               |               |               |
| 8 to 9 GHz                    | 120                                | 110           | 100           | 100           |                              |               |               |               |
| 9 to 10.5 GHz                 | 116                                | 110           | 100           | 100           |                              |               |               |               |
| 10.5 to 12.5 GHz              | 111                                | 110           | 100           | 100           |                              |               |               |               |
| 12.5 to 13.5 GHz              | 108                                | 108           | 100           | 100           |                              |               |               |               |
| 13.5 to 20 GHz                |                                    | 108           | 100           | 100           |                              |               |               |               |
| 20 to 31.25 GHz               |                                    |               | 92            | 92            |                              |               |               |               |
| 31.25 to 40 GHz               |                                    |               | 87            | 87            |                              |               |               |               |
| 40 to 50 GHz                  |                                    |               |               | 75            |                              |               |               |               |

1. The system dynamic range is calculated as the difference between the noise floor and the specified source maximum output power. The effective dynamic range must take measurement uncertainties and interfering signals into account.
2. May be degraded typically by 10 dB at particular frequencies (multiples of 5 MHz) below 500 MHz due to spurious receiver residuals. Methods are available to regain the full dynamic range.
3. May be limited by crosstalk at certain frequencies below 3 MHz.
4. Value and frequency band changed July 2006.

Table 2. Extended dynamic range<sup>1</sup>

**Configurable test set and extended power range**

| Description                   | Specification (dB) at direct receiver access input |            |            |            | Typical (dB) at direct receiver access input |            |            |            |
|-------------------------------|--|------------|------------|------------|--|------------|------------|------------|
|                               | Option 025, 125                                    | Option 225 | Option 425 | Option 525 | Option 025, 125                              | Option 225 | Option 425 | Option 525 |
| 300 kHz to 3 MHz <sup>3</sup> | 108 <sup>4</sup>                                   |            |            |            |  |            |            |            |
| 3 to 10 MHz                   | 128  |            |            |            |  |            |            |            |
| 10 to 45 MHz                  | 137  |            |            |            | 115  | 109        | 109        |            |
| 45 to 70 MHz <sup>2</sup>     | 137  | 113        | 111        | 111        |  |            |            |            |
| 70 to 500 MHz <sup>2</sup>    | 137  | 117        | 111        | 111        |  |            |            |            |
| 500 MHz to 2 GHz              | 137  | 122        | 122        | 122        |  |            |            |            |
| 2 to 6 GHz                    | 137  | 122        | 122        | 122        |  |            |            |            |
| 6 to 8 GHz                    | 136  | 122        | 122        | 122        |  |            |            |            |
| 8 to 9 GHz                    | 136  | 122        | 122        | 122        |  |            |            |            |
| 9 to 10.5 GHz                 | 132  | 122        | 112        | 112        |  |            |            |            |
| 10.5 to 12.5 GHz              | 127  | 122        | 112        | 112        |  |            |            |            |
| 12.5 to 13.5 GHz              | 124  | 120        | 112        | 112        |  |            |            |            |
| 13.5 to 20 GHz                |  | 120        | 112        | 112        |  |            |            |            |
| 20 to 31.25 GHz               |  |            | 103        | 103        |  |            |            |            |
| 31.25 to 40 GHz               |  |            | 98         | 98         |  |            |            |            |
| 40 to 50 GHz                  |  |            |            | 83         |  |            |            |            |

1. The direct receiver access input extended dynamic range is calculated as the difference between the direct receiver access input noise floor and the source maximum output power. The effective dynamic range must take measurement uncertainties and interfering signals into account. This set-up should only be used when the receiver input will never exceed its compression or damage level. When the analyzer is in segment sweep mode, it can have predefined frequency segments which will output a higher power level when the extended dynamic range is required (i.e. devices with high insertion loss), and reduced power when receiver compression or damage may occur (i.e. devices with low insertion loss). The extended range is only available in one-path transmission measurements.
2. May be degraded typically by 10 dB at particular frequencies (multiples of 5 MHz) below 500 MHz due to spurious receiver residuals. Methods are available to regain the full dynamic range.
3. May be limited by crosstalk at certain frequencies below 3 MHz.
4. Value and frequency band changed July 2006.

## N5230A Corrected system performance with 3.5 mm connectors

Table 3. 85052B Calibration kit

N5230A – configurable test set and extended power range (Option 025, 125)

### Configurable test set, extended power range

Applies to the N5230A Option 025.125 analyzers, 85052B (3.5 mm) calibration kit, 85131F flexible test port cable set, and a full 2-port calibration. Also applies to the following condition: Environmental temperature  $23^{\circ} \pm 3^{\circ} \text{C}$ , with  $< 1^{\circ} \text{C}$  deviation from calibration temperature.

| Description           | Specification (dB)                          |   |   |   |
|-----------------------|---|---|---|---|
|                       | 300 kHz to 10 MHz                           | 10 MHz to 2 GHz                             | 2 to 8 GHz                                  | 8 to 13.5 GHz                               |
| Directivity           | 48  | 48  | 44  | 44  |
| Source match          | 40  | 40  | 33  | 31  |
| Load match            | 48  | 48  | 44  | 44  |
| Reflection tracking   | $\pm 0.003$<br>(+0.02/ $^{\circ}\text{C}$ ) | $\pm 0.003$<br>(+0.02/ $^{\circ}\text{C}$ ) | $\pm 0.003$<br>(+0.03/ $^{\circ}\text{C}$ ) | $\pm 0.006$<br>(+0.03/ $^{\circ}\text{C}$ ) |
| Transmission tracking | $\pm 0.017$<br>(+0.02/ $^{\circ}\text{C}$ ) | $\pm 0.015$<br>(+0.02/ $^{\circ}\text{C}$ ) | $\pm 0.075$<br>(+0.03/ $^{\circ}\text{C}$ ) | $\pm 0.131$<br>(+0.03/ $^{\circ}\text{C}$ ) |

### Transmission uncertainty (specifications)

#### Magnitude

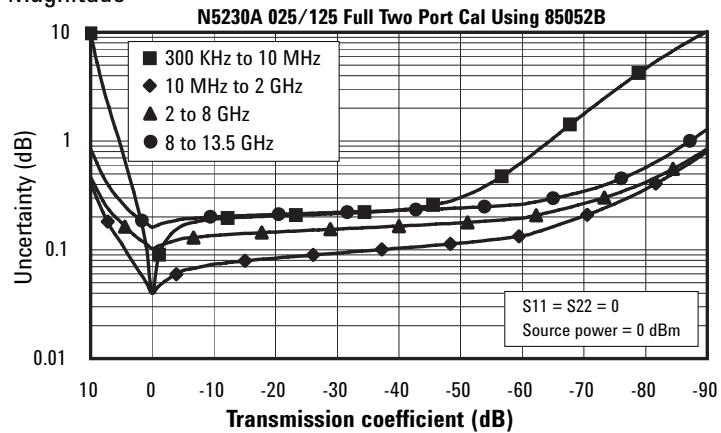

#### Phase

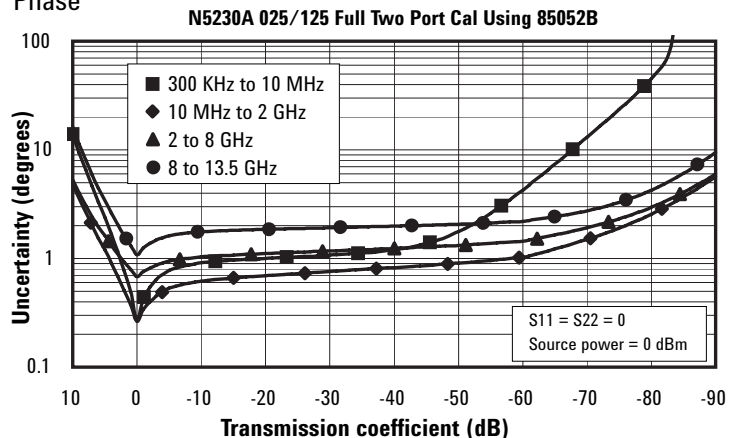

### Reflection uncertainty (specifications)

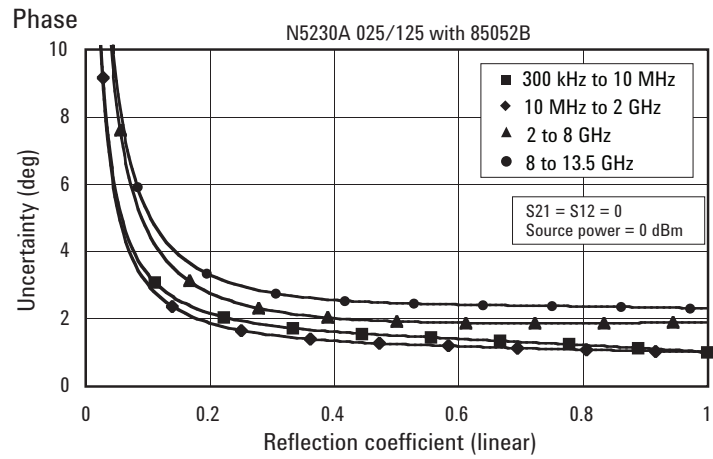
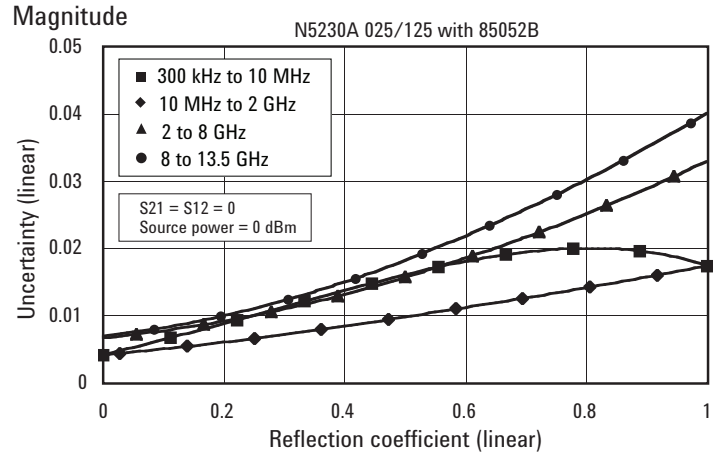

## N5230A Corrected system performance with 3.5 mm connectors

Table 4. 85052B Calibration kit

N5230A – configurable test set and extended power range (Option 225)

### Configurable test set, extended power range

Applies to the N5230A Option 225 analyzers, 85052B (3.5mm) calibration kit, 85131F flexible test port cable set, and a full 2-port calibration. Also applies to the following condition: Environmental temperature  $23^{\circ} \pm 3^{\circ} \text{C}$ , with  $< 1^{\circ} \text{C}$  deviation from calibration temperature.

| Description           | Specification (dB)                          |   |   |   |
|-----------------------|---|---|---|---|
|                       | 45 to 500 MHz                               | 500 MHz to 2 GHz                            | 2 to 8 GHz                                  | 8 to 20 GHz                                 |
| Directivity           | 48  | 48  | 44  | 44  |
| Source match          | 40  | 40  | 33  | 31  |
| Load match            | 48  | 48  | 44  | 44  |
| Reflection tracking   | $\pm 0.003$<br>(+0.02/ $^{\circ}\text{C}$ ) | $\pm 0.003$<br>(+0.02/ $^{\circ}\text{C}$ ) | $\pm 0.003$<br>(+0.03/ $^{\circ}\text{C}$ ) | $\pm 0.006$<br>(+0.03/ $^{\circ}\text{C}$ ) |
| Transmission tracking | $\pm 0.010$<br>(+0.02/ $^{\circ}\text{C}$ ) | $\pm 0.014$<br>(+0.02/ $^{\circ}\text{C}$ ) | $\pm 0.062$<br>(+0.03/ $^{\circ}\text{C}$ ) | $\pm 0.104$<br>(+0.03/ $^{\circ}\text{C}$ ) |

### Transmission uncertainty (specifications)

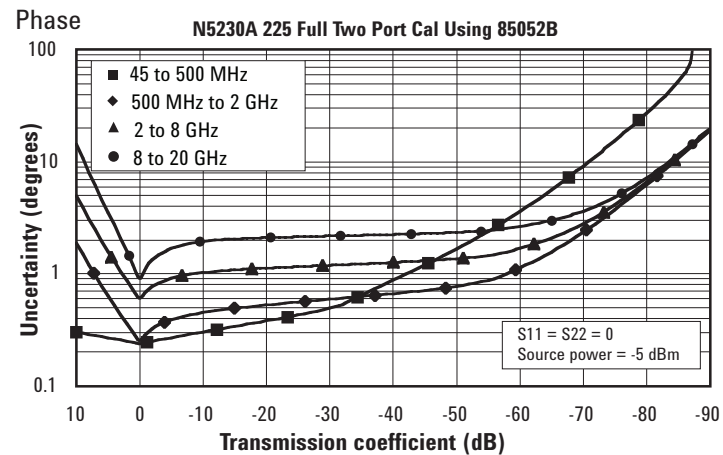
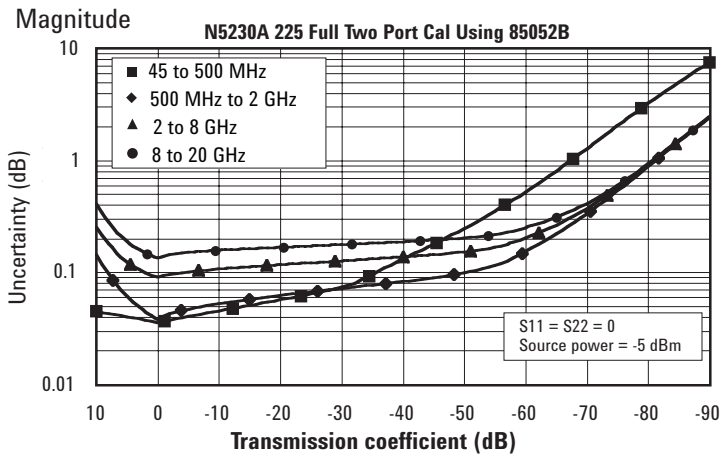

**N4691A Electronic calibration module**  
**N5230A – configurable test set and extended power range (Option 225)**

**Reflection uncertainty (specifications)**

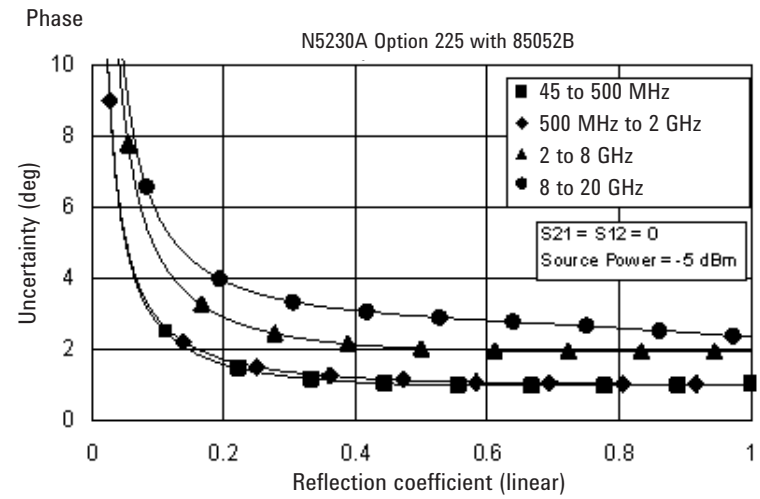
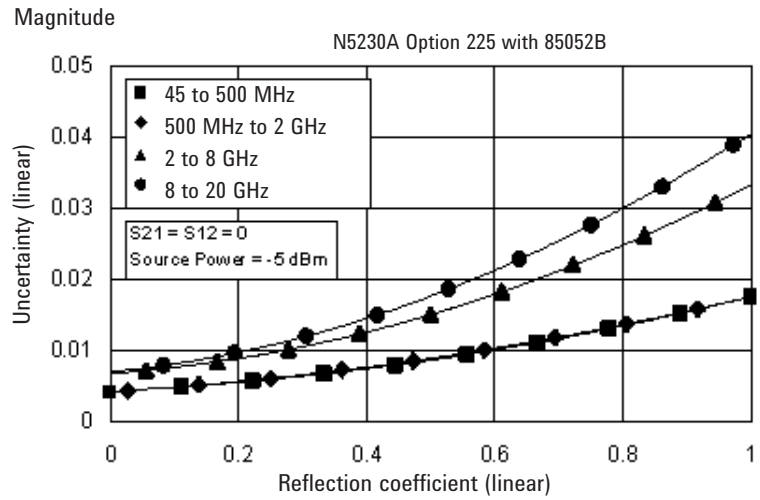

## N5230A Corrected system performance with 3.5 mm connectors

Table 5. N4691B Electronic calibration module

N5230A – configurable test set and extended power range (Option 225)

### Configurable test set, extended power range

Applies to the N5230A Option 225 analyzers, N4691B electronic calibration module, 85131F flexible test port cable set, and a full 2-port calibration. Also applies to the following condition: Environmental temperature  $23^{\circ} \pm 3^{\circ} \text{C}$ , with  $< 1^{\circ} \text{C}$  deviation from calibration temperature.

| Description           | Specification (dB)                          |   |   |   |
|-----------------------|---|---|---|---|
|                       | 45 to 500 MHz                               | 500 MHz to 2 GHz                            | 2 to 8 GHz                                  | 8 to 20 GHz                                 |
| Directivity           | 46  | 56  | 54  | 48  |
| Source match          | 41  | 47  | 45  | 44  |
| Load match            | 41  | 47  | 44  | 42  |
| Reflection tracking   | $\pm 0.050$<br>( $+0.02/^{\circ}\text{C}$ ) | $\pm 0.020$<br>( $+0.02/^{\circ}\text{C}$ ) | $\pm 0.030$<br>( $+0.03/^{\circ}\text{C}$ ) | $\pm 0.040$<br>( $+0.03/^{\circ}\text{C}$ ) |
| Transmission tracking | $\pm 0.053$<br>( $+0.02/^{\circ}\text{C}$ ) | $\pm 0.021$<br>( $+0.02/^{\circ}\text{C}$ ) | $\pm 0.034$<br>( $+0.03/^{\circ}\text{C}$ ) | $\pm 0.052$<br>( $+0.03/^{\circ}\text{C}$ ) |

### Transmission uncertainty (specifications)

#### Magnitude

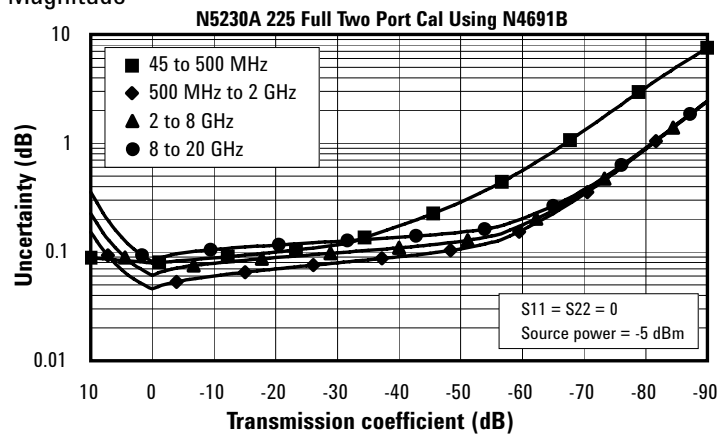

#### Phase

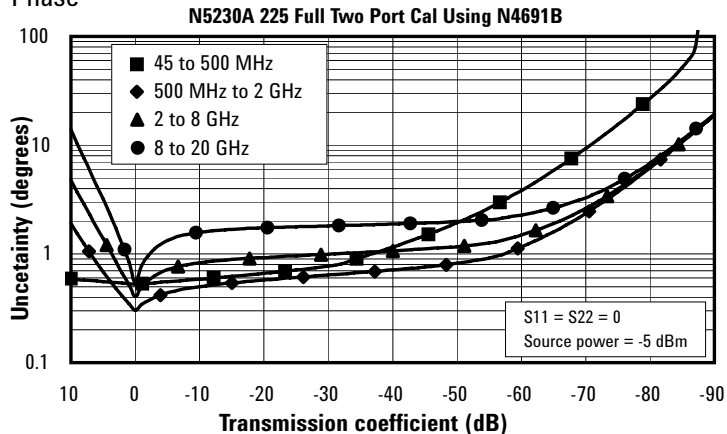

**N4691A Electronic calibration module  
 N5230A – configurable test set and extended power range (Option 225)**

**Reflection uncertainty (specifications)**

**Magnitude**

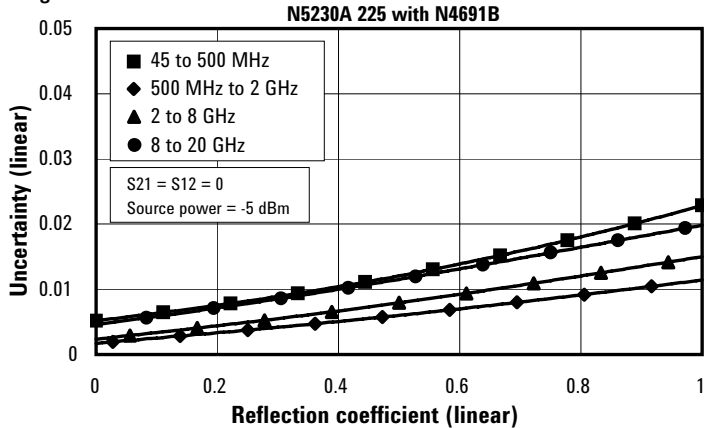

**Phase**

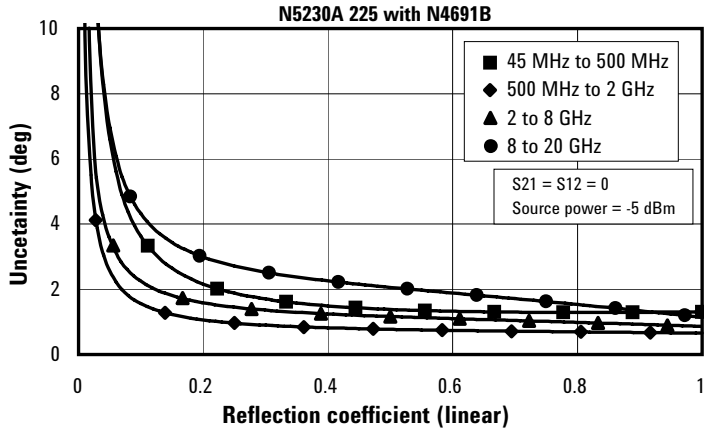

## N5230A Corrected system performance with 2.4 mm connectors

Table 6. 85056A Calibration kit

N5230A – configurable test set and extended power range (Option 425 or 525)

### Configurable test set, extended power range

Applies to the N5230A Option 425 or 525 analyzers, 85056A (2.4 mm) electronic calibration module, 85133F flexible test port cable set, and a full 2-port calibration. Also applies to the following condition: Environmental temperature  $23^{\circ} \pm 3^{\circ} \text{C}$ , with  $< 1^{\circ} \text{C}$  deviation from calibration temperature.

| Description           | Specification (dB)        |                           |                           |                           |
|-----------------------|---------------------------|---------------------------|---------------------------|---------------------------|
|                       | 45 MHz to 2 GHz           | 2 to 20 GHz               | 20 to 40 GHz              | 40 to 50 GHz              |
| Directivity           | 42                        | 42                        | 38                        | 36                        |
| Source match          | 41                        | 38                        | 33                        | 31                        |
| Load match            | 42                        | 42                        | 37                        | 35                        |
| Reflection tracking   | $\pm 0.001$<br>(+0.02/°C) | $\pm 0.008$<br>(+0.02/°C) | $\pm 0.020$<br>(+0.02/°C) | $\pm 0.027$<br>(+0.03/°C) |
| Transmission tracking | $\pm 0.019$<br>(+0.02/°C) | $\pm 0.057$<br>(+0.02/°C) | $\pm 0.124$<br>(+0.02/°C) | $\pm 0.211$<br>(+0.03/°C) |

### Transmission uncertainty (specifications)

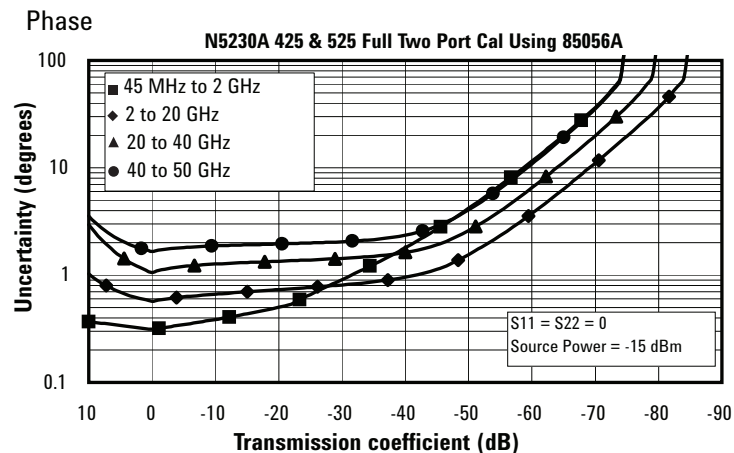
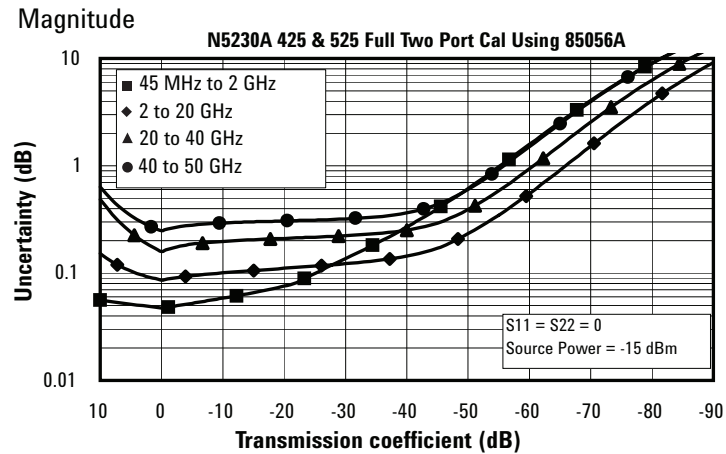

### Reflection uncertainty (specifications)

#### Magnitude

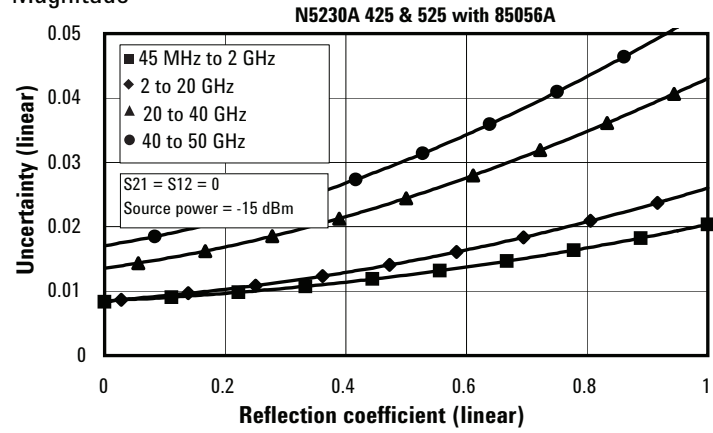

#### Phase

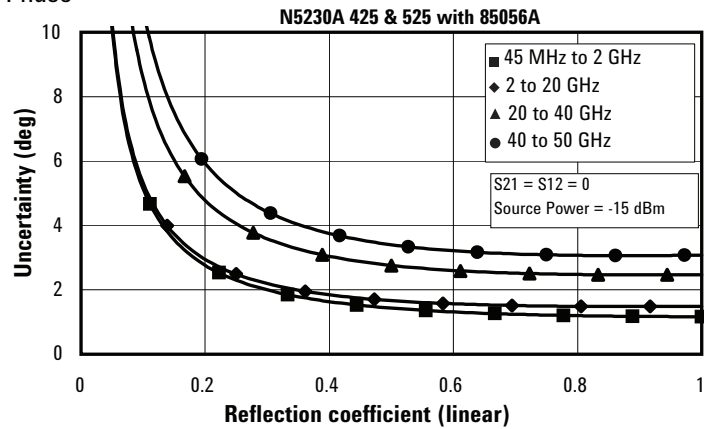

Table 7. N4693A Electronic calibration module

**N5230A – configurable test set and extended power range (Option 425 or 525)**

**Configurable test set, extended power range**

Applies to the N5230A Option 425 or 525 analyzers, N4693A (2.4 mm) electronic calibration module, 85133F flexible test port cable set, and a full 2-port calibration. Also applies to the following condition: Environmental temperature  $23^{\circ} \pm 3^{\circ} \text{C}$ , with  $< 1^{\circ} \text{C}$  deviation from calibration temperature

| Description           | Typical (dB)             | Specification (dB)        |                           |                           |                           |
|-----------------------|--------------------------|---------------------------|---------------------------|---------------------------|---------------------------|
|                       | 10 to 200 MHz            | 200 MHz to 2 GHz          | 2 to 20 GHz               | 20 to 40 GHz              | 40 to 50 GHz              |
| Directivity           | 32                       | 55                        | 49                        | 43                        | 41                        |
| Source match          | 25                       | 46                        | 42                        | 35                        | 30                        |
| Load match            | 24                       | 43                        | 41                        | 37                        | 36                        |
| Reflection tracking   | $\pm 0.05$<br>(+0.02/°C) | $\pm 0.030$<br>(+0.02/°C) | $\pm 0.040$<br>(+0.02/°C) | $\pm 0.060$<br>(+0.02/°C) | $\pm 0.080$<br>(+0.03/°C) |
| Transmission tracking | $\pm 0.10$<br>(+0.02/°C) | $\pm 0.056$<br>(+0.02/°C) | $\pm 0.078$<br>(+0.02/°C) | $\pm 0.107$<br>(+0.02/°C) | $\pm 0.130$<br>(+0.03/°C) |

**Transmission uncertainty (specifications)**

**Magnitude**

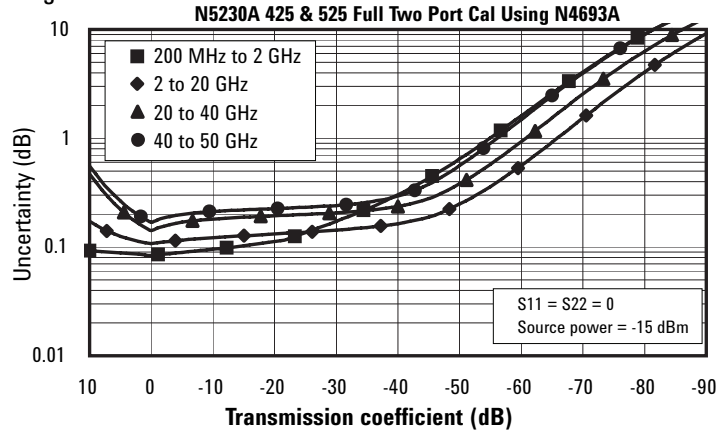

**Phase**

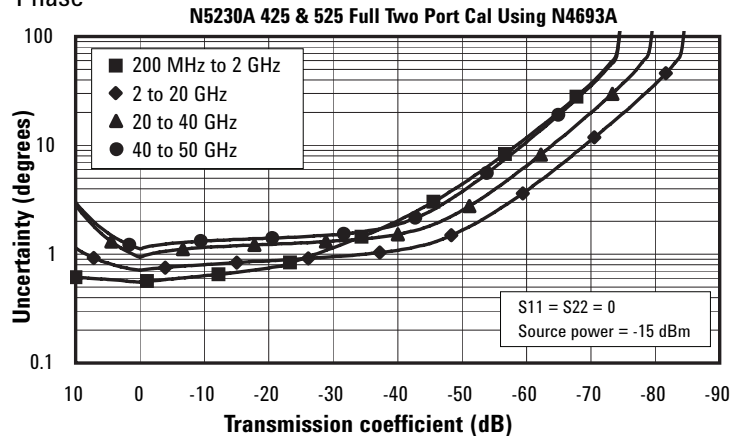

**Reflection uncertainty (specifications)**

**Magnitude**

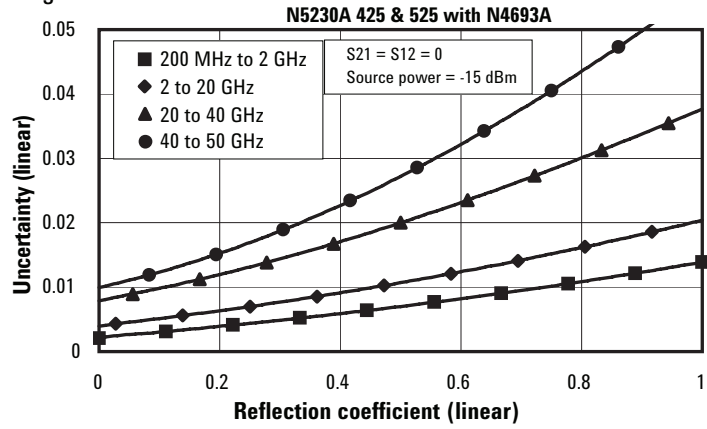

**Phase**

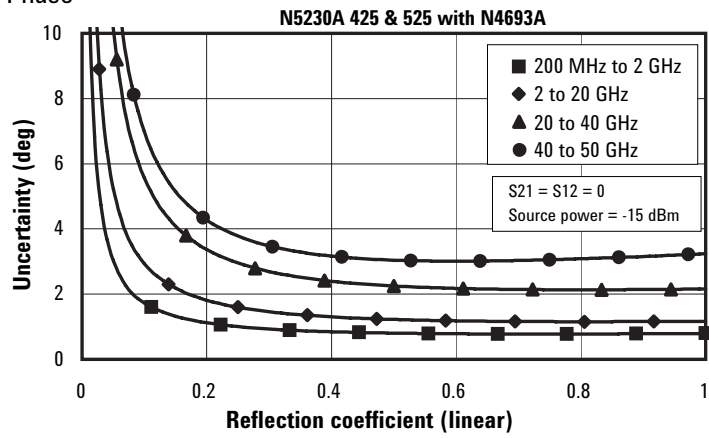

## N5230A Corrected system performance with Type-N connectors

Table 8. 85032B Calibration kit

N5230A – configurable test set and extended power range (Option 025)

### Configurable test set, extended power range

Applies to the N5230A Option 025 analyzers, 85032B (Type-N) calibration kit, 85132F flexible test port cable set with 85130C adapter set, and a full 2-port calibration. Also applies to the following condition: Environmental temperature  $23^{\circ} \pm 3^{\circ} \text{C}$ , with  $< 1^{\circ} \text{C}$  deviation from calibration temperature.

| Description           | Specification (dB)                          |   |   |   |
|-----------------------|---|---|---|---|
|                       | 300 kHz to 1 MHz                            | 1 to 10 MHz                                 | 10 to 45 MHz                                | 45 MHz to 6 GHz                             |
| Directivity           | 50  | 50  | 47  | 40  |
| Source match          | 42  | 42  | 37  | 31  |
| Load match            | 50  | 50  | 47  | 38  |
| Reflection tracking   | $\pm 0.009$<br>( $+0.01/^{\circ}\text{C}$ ) | $\pm 0.009$<br>( $+0.01/^{\circ}\text{C}$ ) | $\pm 0.019$<br>( $+0.01/^{\circ}\text{C}$ ) | $\pm 0.069$<br>( $+0.02/^{\circ}\text{C}$ ) |
| Transmission tracking | $\pm 0.013$<br>( $+0.01/^{\circ}\text{C}$ ) | $\pm 0.007$<br>( $+0.01/^{\circ}\text{C}$ ) | $\pm 0.021$<br>( $+0.01/^{\circ}\text{C}$ ) | $\pm 0.101$<br>( $+0.02/^{\circ}\text{C}$ ) |

### Transmission uncertainty (specifications)

#### Magnitude

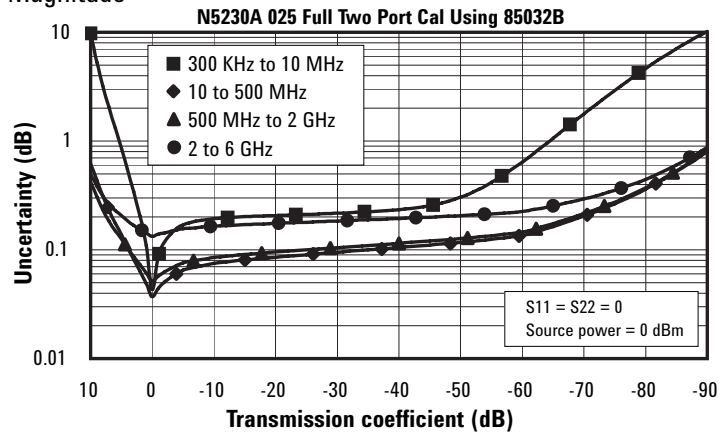

#### Phase

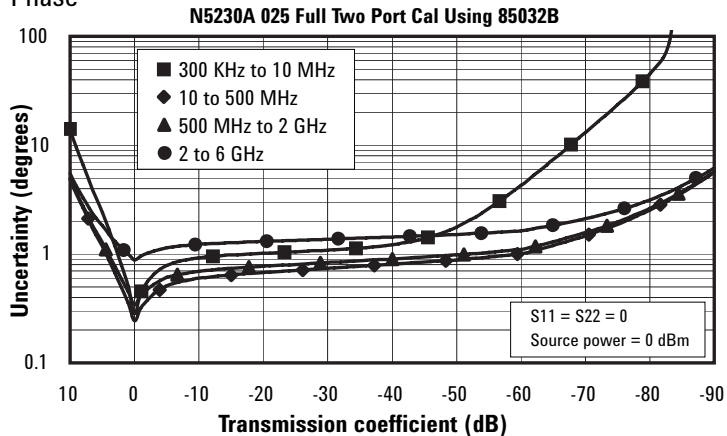

**Transmission uncertainty (specifications)**

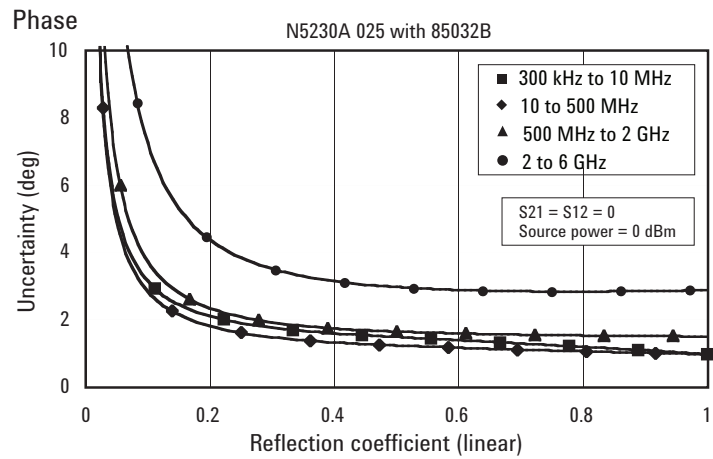
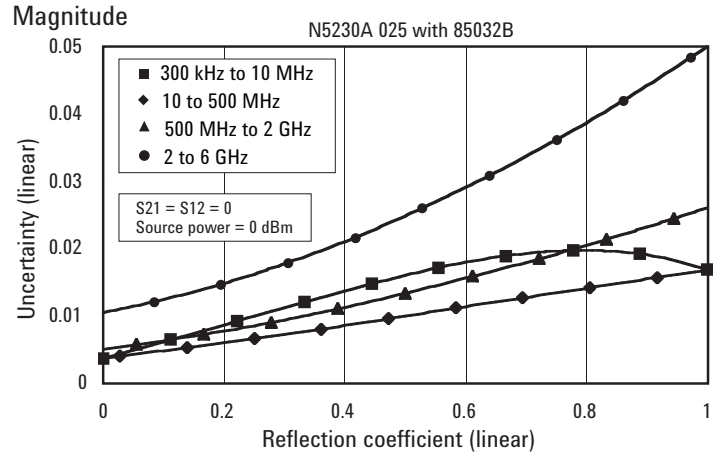

**Table 9. Uncorrected system performance**

| Directivity                  | Specifications                       |                            |                            |                            | Typicals                             |                            |                            |                            |
|------------------------------|--------------------------------------|----------------------------|----------------------------|----------------------------|--------------------------------------|----------------------------|----------------------------|----------------------------|
|                              | Option<br>020, 025, 120, 125         | Option<br>220, 225         | Option<br>420, 425         | Option<br>520, 525         | Option<br>020, 025, 120, 125         | Option<br>220, 225         | Option<br>420, 425         | Option<br>520, 525         |
| 300 kHz to 10 MHz            | 16 dB                                |                            |                            |                            |                                      |                            |                            |                            |
| 10 to 45 MHz                 | 28 dB                                |                            |                            |                            |                                      | 23 dB                      | 20 dB                      | 20 dB                      |
| 45 to 500 MHz                | 28 dB                                | 24 dB                      | 23 dB                      | 23 dB                      |                                      |                            |                            |                            |
| 500 MHz to 1 GHz             | 28 dB                                | 27 dB                      | 23 dB                      | 23 dB                      |                                      |                            |                            |                            |
| 1 to 2 GHz                   | 25 dB                                | 27 dB                      | 23 dB                      | 23 dB                      |                                      |                            |                            |                            |
| 2 to 3 GHz                   | 25 dB                                | 21 dB                      | 21 dB                      | 21 dB                      |                                      |                            |                            |                            |
| 3 to 5 GHz                   | 20 dB                                | 21 dB                      | 21 dB                      | 21 dB                      |                                      |                            |                            |                            |
| 5 to 8 GHz                   | 17 dB                                | 21 dB                      | 21 dB                      | 21 dB                      |                                      |                            |                            |                            |
| 8 to 11.5 GHz                | 17 dB                                | 16 dB                      | 16 dB                      | 16 dB                      |                                      |                            |                            |                            |
| 11.5 to 13.5 GHz             | 15 dB                                | 16 dB                      | 16 dB                      | 16 dB                      |                                      |                            |                            |                            |
| 13.5 to 20 GHz               |                                      | 16 dB                      | 16 dB                      | 16 dB                      |                                      |                            |                            |                            |
| 20 to 40 GHz                 |                                      |                            | 15 dB                      | 15 dB                      |                                      |                            |                            |                            |
| 40 to 50 GHz                 |                                      |                            |                            | 13 dB                      |                                      |                            |                            |                            |
| <b>Source match</b>          | <b>Option<br/>020, 025, 120, 125</b> | <b>Option<br/>220, 225</b> | <b>Option<br/>420, 425</b> | <b>Option<br/>520, 525</b> | <b>Option<br/>020, 025, 120, 125</b> | <b>Option<br/>220, 225</b> | <b>Option<br/>420, 425</b> | <b>Option<br/>520, 525</b> |
| 300 kHz to 10 MHz            | 18 dB                                |                            |                            |                            |                                      |                            |                            |                            |
| 10 to 45 MHz                 | 25 dB                                |                            |                            |                            |                                      | 12 dB                      | 11 dB                      | 11 dB                      |
| 45 to 500 MHz                | 25 dB                                | 20 dB                      | 17 dB                      | 17 dB                      |                                      |                            |                            |                            |
| 500 MHz to 2 GHz             | 21 dB                                | 17 dB                      | 17 dB                      | 17 dB                      |                                      |                            |                            |                            |
| 2 to 3 GHz                   | 19 dB                                | 12 dB                      | 12 dB                      | 12 dB                      |                                      |                            |                            |                            |
| 3 to 8 GHz                   | 12 dB                                | 12 dB                      | 12 dB                      | 12 dB                      |                                      |                            |                            |                            |
| 8 to 9 GHz                   | 12 dB                                | 11 dB                      | 11 dB                      | 11 dB                      |                                      |                            |                            |                            |
| 9 to 12.5 GHz                | 10 dB                                | 11 dB                      | 11 dB                      | 11 dB                      |                                      |                            |                            |                            |
| 12.5 to 13.5 GHz             | 8 dB                                 | 10 dB                      | 11 dB                      | 11 dB                      |                                      |                            |                            |                            |
| 13.5 to 20 GHz               |                                      | 10 dB                      | 11 dB                      | 11 dB                      |                                      |                            |                            |                            |
| 20 to 40 GHz                 |                                      |                            | 7 dB                       | 7 dB                       |                                      |                            |                            |                            |
| 40 to 50 GHz                 |                                      |                            |                            | 6 dB                       |                                      |                            |                            |                            |
| <b>Load match</b>            | <b>Option<br/>020, 025, 120, 125</b> | <b>Option<br/>220, 225</b> | <b>Option<br/>420, 520</b> | <b>Option<br/>425, 525</b> | <b>Option<br/>020, 025, 120, 125</b> | <b>Option<br/>220, 225</b> | <b>Option<br/>420, 425</b> | <b>Option<br/>520, 525</b> |
| 300 kHz to 10 MHz            | 17 dB                                |                            |                            |                            |                                      |                            |                            |                            |
| 10 to 45 MHz                 | 22 dB                                |                            |                            |                            |                                      | 15 dB                      | 13 dB                      | 13 dB                      |
| 45 to 500 MHz                | 22 dB                                | 22 dB                      | 18 dB                      | 18 dB                      |                                      |                            |                            |                            |
| 500 MHz to 2 GHz             | 17 dB                                | 20 dB                      | 18 dB                      | 18 dB                      |                                      |                            |                            |                            |
| 2 to 3 GHz                   | 14 dB                                | 12 dB                      | 14 dB                      | 14 dB                      |                                      |                            |                            |                            |
| 3 to 8 GHz                   | 10 dB                                | 12 dB                      | 14 dB                      | 14 dB                      |                                      |                            |                            |                            |
| 8 to 9 GHz                   | 9 dB                                 | 10 dB                      | 12 dB                      | 12 dB                      |                                      |                            |                            |                            |
| 9 to 12.5 GHz                | 9 dB                                 | 10 dB                      | 12 dB                      | 12 dB                      |                                      |                            |                            |                            |
| 12.5 to 13.5 GHz             | 7 dB                                 | 9 dB                       | 9 dB                       | 9.5 dB                     |                                      |                            |                            |                            |
| 13.5 to 20 GHz               |                                      | 9 dB                       | 9 dB                       | 9.5 dB                     |                                      |                            |                            |                            |
| 20 to 40 GHz                 |                                      |                            | 8 dB                       | 8.5 dB                     |                                      |                            |                            |                            |
| 40 to 50 GHz                 |                                      |                            | 5 dB                       | 5 dB                       |                                      |                            |                            |                            |
| <b>Crosstalk<sup>1</sup></b> | <b>Option<br/>020, 025, 120, 125</b> | <b>Option<br/>220, 225</b> | <b>Option<br/>420, 425</b> | <b>Option<br/>520, 525</b> | <b>Option<br/>020, 025, 120, 125</b> | <b>Option<br/>220, 225</b> | <b>Option<br/>420, 425</b> | <b>Option<br/>520, 525</b> |
| 300 kHz to 10 MHz            |                                      |                            |                            |                            | 75 dB <sup>2</sup>                   |                            |                            |                            |
| 10 to 45 MHz                 |                                      |                            |                            |                            | 115 dB                               | 88 dB                      | 88 dB                      | 88 dB                      |
| 45 to 500 MHz                |                                      |                            |                            |                            | 122 dB                               | 95 dB                      | 94 dB                      | 94 dB                      |
| 500 MHz to 2 GHz             |                                      |                            |                            |                            | 122 dB                               | 96 dB                      | 95 dB                      | 95 dB                      |
| 2 to 8 GHz                   |                                      |                            |                            |                            | 122 dB                               | 110 dB                     | 108 dB                     | 108 dB                     |
| 8 to 10.5 GHz                |                                      |                            |                            |                            | 120 dB                               | 116 dB                     | 113 dB                     | 113 dB                     |
| 10.5 to 12.5 GHz             |                                      |                            |                            |                            | 115 dB                               | 116 dB                     | 113 dB                     | 113 dB                     |
| 12.5 to 13.5 GHz             |                                      |                            |                            |                            | 109 dB                               | 115 dB                     | 112 dB                     | 112 dB                     |
| 13.5 to 20 GHz               |                                      |                            |                            |                            |                                      | 115 dB                     | 112 dB                     | 112 dB                     |
| 20 to 40 GHz                 |                                      |                            |                            |                            |                                      |                            | 97 dB                      | 97 dB                      |
| 40 to 50 GHz                 |                                      |                            |                            |                            |                                      |                            |                            | 89 dB                      |

1. Measurement conditions: normalized to a thru, measured with two shorts, 10 Hz IF bandwidth, averaging factor of 8, alternate mode, source power set to the specified maximum power output or the minimum receiver input power specified by the 0.1 dB compression power.

2. Value changed July 2006.

Table 10. Test port output<sup>1</sup>

| Description                 | Specifications  |                     |                  |                  |                  | Typicals                  |                 |                 |                 |
|-----------------------------|---|---------------------|------------------|------------------|------------------|---------------------------|-----------------|-----------------|-----------------|
|                             | Option 020, 025   | Option 120, 125     | Option 220, 225  | Option 420, 425  | Option 520, 525  | Option 020, 025, 120, 125 | Option 220, 225 | Option 420, 425 | Option 520, 525 |
| <b>Frequency range</b>      |   |                     |                  |                  |                  |                           |                 |                 |                 |
| <b>N5230A</b>               | 300 kHz to 6 GHz  | 300 kHz to 13.5 GHz | 10 MHz to 20 GHz | 10 MHz to 40 GHz | 10 MHz to 50 GHz |                           |                 |                 |                 |
| <b>Nominal power</b>        | Preset power; attenuator switch point 10 dB below nominal power |                     |                  |                  |                  |                           |                 |                 |                 |
|                             | 0 dBm   | 0 dBm               | -5 dBm           | -10 dBm          | -15 dBm          |                           |                 |                 |                 |
| <b>Frequency resolution</b> | 1 Hz  |                     |                  |                  |                  |                           |                 |                 |                 |
| <b>CW accuracy</b>          | ±1 ppm  |                     |                  |                  |                  |                           |                 |                 |                 |
| <b>Frequency stability</b>  | ±0.05 ppm. -10° to 70° C<br>±0.1 ppm/yr maximum                 |                     |                  |                  |                  |                           |                 |                 |                 |

| Description                 | Specifications                          |                 |                 |            |            | Typicals                  |                 |                           |         |
|-----------------------------|---|-----------------|-----------------|------------|------------|---------------------------|-----------------|---------------------------|---------|
|                             | Option 020, 025, 120, 125               | Option 220, 225 | Option 420, 425 | Option 520 | Option 525 | Option 020, 025, 120, 125 | Option 220, 225 | Option 420, 425, 520, 525 |         |
| <b>Power level accuracy</b> | Variation from nominal power in range 0 |                 |                 |            |            |                           |                 |                           |         |
| 300 kHz to 10 MHz           | ±1.0 dB                                 |                 |                 |            |            |                           |                 |                           |         |
| 10 to 45 MHz                | ±1.0 dB                                 |                 |                 |            |            |                           |                 | ±0.5 dB                   | ±0.5 dB |
| 45 MHz to 6 GHz             | ±1.0 dB                                 | ±1.0 dB         | ±1.0 dB         | ±1.0 dB    | ±1.0 dB    |                           |                 |                           |         |
| 6 to 8 GHz                  | ±1.5 dB                                 | ±1.0 dB         | ±1.0 dB         | ±1.0 dB    | ±1.0 dB    |                           |                 |                           |         |
| 8 to 9 GHz                  | ±1.5 dB                                 | ±1.0 dB         | ±1.5 dB         | ±1.5 dB    | ±1.5 dB    |                           |                 |                           |         |
| 9 to 10.5 GHz               | ±1.5 dB                                 | ±1.0 dB         | ±1.5 dB         | ±1.5 dB    | ±1.5 dB    |                           |                 |                           |         |
| 10.5 to 13.5 GHz            | ±2.0 dB                                 | ±1.0 dB         | ±1.5 dB         | ±1.5 dB    | ±1.5 dB    |                           |                 |                           |         |
| 13.5 to 20 GHz              |   | ±1.0 dB         | ±1.5 dB         | ±1.5 dB    | ±1.5 dB    |                           |                 |                           |         |
| 20 to 40 GHz                |   |                 | ±2.5 dB         | ±2.5 dB    | ±2.5 dB    |                           |                 |                           |         |
| 40 to 50 GHz                |   |                 |                 | ±3.5 dB    | ±3.5 dB    |                           |                 |                           |         |

| Description                                  | Specifications  |                 |                 |            |            |            |            | Typicals                    |  |
|--|-----------------|-----------------|-----------------|------------|------------|------------|------------|-----------------------------|--|
|  | Option 020, 120 | Option 025, 125 | Option 220, 225 | Option 420 | Option 425 | Option 520 | Option 525 | Option 220, 225             |  |
| <b>Max leveled power</b>                     |                 |                 |                 |            |            |            |            |                             |  |
| 300 kHz to 10 MHz                            | 10 dBm          | 9 dBm           |                 |            |            |            |            |                             |  |
| 10 to 45 MHz                                 | 10 dBm          | 9 dBm           |                 |            |            |            |            | 5 dBm                       |  |
| 45 MHz to 6 GHz                              | 10 dBm          | 9 dBm           | 5 dBm           | 0 dBm      | 0 dBm      | 0 dBm      | 0 dBm      |                             |  |
| 6 to 9 GHz                                   | 8 dBm           | 8 dBm           | 5 dBm           | 0 dBm      | 0 dBm      | 0 dBm      | 0 dBm      |                             |  |
| 9 to 12.5 GHz                                | 4 dBm           | 4 dBm           | 5 dBm           | 0 dBm      | 0 dBm      | 0 dBm      | 0 dBm      |                             |  |
| 12.5 to 13.5 GHz                             | 2 dBm           | 1 dBm           | 3 dBm           | 0 dBm      | 0 dBm      | 0 dBm      | 0 dBm      |                             |  |
| 13.5 to 20 GHz                               |                 |                 | 3 dBm           | 0 dBm      | 0 dBm      | 0 dBm      | 0 dBm      |                             |  |
| 20 to 40 GHz                                 |                 |                 |                 | -5 dBm     | -8 dBm     | -5 dBm     | -8 dBm     |                             |  |
| 40 to 50 GHz                                 |                 |                 |                 |            |            | -11 dBm    | -15 dBm    |                             |  |
| <b>Power level linearity<sup>2</sup></b>     |                 |                 |                 |            |            |            |            | <b>Options as indicated</b> |  |
| Test reference is at the nominal power level |                 |                 |                 |            |            |            |            |                             |  |
| 300 kHz to 1 MHz                             | ±4.5 dB         | ±4.5 dB         |                 |            |            |            |            |                             | ±2.0 dB (Opt 020, 025, 120, 125)                             |
| 1 to 10 MHz                                  | ±1.0 dB         | ±1.0 dB         |                 |            |            |            |            |                             |  |
| 10 to 45 MHz                                 | ±2.0 dB         | ±2.0 dB         |                 |            |            |            |            |                             | ±0.35 dB (Opt 220, 225)<br>±0.40 dB (Opt 420, 425, 520, 525) |
| 45 MHz to 1 GHz                              | ±2.0 dB         | ±2.0 dB         | ±1.0 dB         | ±1.0 dB    | ±1.0 dB    | ±1.0 dB    | ±1.0 dB    |                             |  |
| 1 to 12.5 GHz                                | ±1.5 dB         | ±1.5 dB         | ±1.0 dB         | ±1.0 dB    | ±1.0 dB    | ±1.0 dB    | ±1.0 dB    |                             |  |
| 12.5 to 13.5 GHz                             | ±1.5 dB         | ±1.5 dB         | ±1.0 dB         | ±1.0 dB    | ±1.0 dB    | ±1.0 dB    | ±1.0 dB    |                             |  |
| 13.5 to 20 GHz                               |                 |                 | ±1.0 dB         | ±1.0 dB    | ±1.0 dB    | ±1.0 dB    | ±1.0 dB    |                             |  |
| 20 to 40 GHz                                 |                 |                 |                 | ±1.0 dB    | ±1.0 dB    | ±1.0 dB    | ±1.0 dB    |                             |  |
| 40 to 50 GHz                                 |                 |                 |                 |            | ±1.0 dB    | ±1.0 dB    | ±1.0 dB    |                             |  |

1. Performance specified on Port 1 only. Port 2 performance is a characteristic.  
 2. Power level linearity specified on Port 1 only. Port 2 performance is typical.  
 Test reference is at the nominal power level.

Table 10. Test port output<sup>1</sup> (Continued)

| Description                                | Specifications  |                 |                 |            |            |            |            | Typicals                    |
|--|-----------------|-----------------|-----------------|------------|------------|------------|------------|-----------------------------|
|  | Option 020, 120 | Option 025, 125 | Option 220, 225 | Option 420 | Option 425 | Option 520 | Option 525 | Option 220, 225             |
| <b>Power sweep range (ALC)<sup>2</sup></b> |                 |                 |                 |            |            |            |            |                             |
| 300 kHz to 10 MHz                          | 37 dB           | 36 dB           |                 |            |            |            |            |                             |
| 10 to 45 MHz                               | 37 dB           | 36 dB           |                 |            |            |            |            | 25 dB                       |
| 45 MHz to 6 GHz                            | 37 dB           | 36 dB           | 25 dB           | 25 dB      | 25 dB      | 25 dB      | 25 dB      |                             |
| 6 to 9 GHz                                 | 35 dB           | 35 dB           | 25 dB           | 25 dB      | 25 dB      | 25 dB      | 25 dB      |                             |
| 9 to 12.5 GHz                              | 31 dB           | 31 dB           | 25 dB           | 25 dB      | 25 dB      | 25 dB      | 25 dB      |                             |
| 12.5 to 13.5 GHz                           | 29 dB           | 28 dB           | 23 dB           | 25 dB      | 25 dB      | 25 dB      | 25 dB      |                             |
| 13.5 to 20 GHz                             |                 |                 | 23 dB           | 25 dB      | 25 dB      | 25 dB      | 25 dB      |                             |
| 20 to 40 GHz                               |                 |                 |                 | 20 dB      | 17 dB      | 20 dB      | 17 dB      |                             |
| 40 to 50 GHz                               |                 |                 |                 |            |            | 14 dB      | 10 dB      |                             |
| <b>Power resolution</b>                    |                 |                 |                 |            |            |            |            | <b>Options as indicated</b> |
|  |                 |                 |                 |            |            |            |            | 0.01 dB (all options)       |

| Description           | Specification | Typicals        |                 |                |                |                 |                 |
|-----------------------|---------------|-----------------|-----------------|----------------|----------------|-----------------|-----------------|
|                       |               | Option 020, 120 | Option 025, 125 | Option 220     | Option 225     | Option 420, 520 | Option 425, 525 |
| <b>Power range</b>    |               |                 |                 |                |                |                 |                 |
| 300 kHz to 10 MHz     |               | -30 to +10 dBm  | -90 to +9 dBm   |                |                |                 |                 |
| 10 to 45 MHz          |               | -30 to +10 dBm  | -90 to +9 dBm   | -27 to +12 dBm | -87 to +12 dBm | -27 to +9 dBm   | -87 to +8 dBm   |
| 45 MHz to 6 GHz       |               | -30 to +10 dBm  | -90 to +9 dBm   | -27 to +12 dBm | -87 to +12 dBm | -27 to +8 dBm   | -87 to +8 dBm   |
| 6 to 9 GHz            |               | -30 to +8 dBm   | -90 to +8 dBm   | -27 to +12 dBm | -87 to +12 dBm | -27 to +8 dBm   | -87 to +8 dBm   |
| 9 to 12.5 GHz         |               | -30 to +4 dBm   | -90 to +4 dBm   | -27 to +12 dBm | -87 to +12 dBm | -27 to +8 dBm   | -87 to +8 dBm   |
| 12.5 to 13.5 GHz      |               | -30 to +2 dBm   | -90 to +1 dBm   | -27 to +7 dBm  | -87 to +7 dBm  | -27 to +5 dBm   | -87 to +4 dBm   |
| 13.5 to 20 GHz        |               |                 |                 | -27 to +7 dBm  | -87 to +7 dBm  | -27 to +5 dBm   | -87 to +4 dBm   |
| 20 to 40 GHz          |               |                 |                 |                |                | -27 to +1 dBm   | -87 to -2 dBm   |
| 40 to 50 GHz          |               |                 |                 |                |                | -27 to -5 dBm   | -87 to -9 dBm   |
| <b>Power settings</b> |               |                 |                 |                |                |                 |                 |
| Minimum power setting |               | -33 dBm         | -93 dBm         | -30 dBm        | -90 dBm        | -30 dBm         | -90 dBm         |
| Maximum power setting |               | +20 dBm         | +20 dBm         | +20 dBm        | +20 dBm        | +20 dBm         | +20 dBm         |

| Description                                     | Specification | Typicals                  |                       |                     |                                     |                       |                     |
|---|---------------|---------------------------|-----------------------|---------------------|-------------------------------------|-----------------------|---------------------|
|   |               | Option 020, 025, 120, 125 |                       |                     | Option 220, 225, 420, 425, 520, 525 |                       |                     |
| <b>Phase noise (Nominal power at test port)</b> |               |                           |                       |                     |                                     |                       |                     |
|   |               | <b>10 kHz Offset</b>      | <b>100 kHz Offset</b> | <b>1 MHz Offset</b> | <b>10 kHz Offset</b>                | <b>100 kHz Offset</b> | <b>1 MHz Offset</b> |
| 300 kHz to 10 MHz                               |               | -86 dBc/Hz                | -86 dBc/Hz            | -95 dBc/Hz          |                                     |                       |                     |
| 10 MHz to 1.5 GHz                               |               | -86 dBc/Hz                | -91 dBc/Hz            | -95 dBc/Hz          | -77 dBc/Hz                          | -77 dBc/Hz            | -89 dBc/Hz          |
| 1.5 to 3.125 GHz                                |               | -83 dBc/Hz                | -91 dBc/Hz            | -95 dBc/Hz          | -83 dBc/Hz                          | -91 dBc/Hz            | -95 dBc/Hz          |
| 3.125 to 6.25 GHz                               |               | -77 dBc/Hz                | -85 dBc/Hz            | -89 dBc/Hz          | -77 dBc/Hz                          | -85 dBc/Hz            | -89 dBc/Hz          |
| 6.25 to 12.5 GHz                                |               | -71 dBc/Hz                | -79 dBc/Hz            | -83 dBc/Hz          | -71 dBc/Hz                          | -79 dBc/Hz            | -83 dBc/Hz          |
| 12.5 to 13.5 GHz                                |               | -65 dBc/Hz                | -73 dBc/Hz            | -77 dBc/Hz          | -65 dBc/Hz                          | -73 dBc/Hz            | -77 dBc/Hz          |
| 13.5 to 20 GHz                                  |               |                           |                       |                     | -65 dBc/Hz                          | -73 dBc/Hz            | -77 dBc/Hz          |
| 20 to 40 GHz                                    |               |                           |                       |                     | -59 dBc/Hz                          | -67 dBc/Hz            | -71 dBc/Hz          |
| 40 to 50 GHz                                    |               |                           |                       |                     | -59 dBc/Hz                          | -67 dBc/Hz            | -71 dBc/Hz          |

|  |  |  |  |                                      |  |  |  |
|--|--|--|--|--------------------------------------|--|--|--|
| <b>Non-harmonic spurious (at nominal output power)</b> |  |  |  |                                      |  |  |  |
| 300 kHz to 10 MHz                                      |  |  |  |                                      |  |  |  |
| 10 MHz to 13.5 GHz                                     |  |  |  | -50 dBc for offset frequency > 1 kHz |  |  |  |
| 13.5 to 20 GHz   |  |  |  |                                      |  |  |  |
| 20 to 40 GHz   |  |  |  | -30 dBc for offset frequency > 1 kHz |  |  |  |
| 40 to 50 GHz   |  |  |  |                                      |  |  |  |

| Description   | Specification | Typicals                  |                 |                 |                 |
|---|---------------|---------------------------|-----------------|-----------------|-----------------|
|   |               | Option 020, 025, 120, 125 | Option 220, 225 | Option 420, 425 | Option 520, 525 |
| <b>Harmonics (2nd or 3rd) at maximum output power</b> |               |                           |                 |                 |                 |
| 300 kHz to 10 MHz                                     |               | -17 dBc                   |                 |                 |                 |
| 10 to 500 MHz   |               | -17 dBc                   | -22 dBc         | -15 dBc         | -15 dBc         |
| 500 MHz to 1 GHz                                      |               | -17 dBc                   | -22 dBc         | -15 dBc         | -15 dBc         |
| 1 to 13.5 GHz   |               | -20 dBc                   | -22 dBc         | -20 dBc         | -20 dBc         |
| 13.5 to 20 GHz  |               |                           | -22 dBc         | -20 dBc         | -20 dBc         |
| 20 to 40 GHz  |               |                           |                 | -22 dBc         | -22 dBc         |
| 40 to 50 GHz  |               |                           |                 |                 | -22 dBc         |

1. Performance specified on Port 1 only. Port 2 performance is a characteristic.

2. ALC range starts at maximum leveled power and decreases in power level indicated by the dB amount specified here.

Table 11: Test port input

| Description  | Specifications               |                    |                    |                    | Typicals                         |                    |                    |                    |
|--|------------------------------|--------------------|--------------------|--------------------|----------------------------------|--------------------|--------------------|--------------------|
|  | Option<br>020, 025, 120, 125 | Option<br>220, 225 | Option<br>420, 425 | Option<br>520, 525 | Option<br>020, 025, 120, 125     | Option<br>220, 225 | Option<br>420, 425 | Option<br>520, 525 |
| <b>Test port noise floor<sup>1</sup> 10 Hz IF bandwidth<sup>2</sup></b>                    |                              |                    |                    |                    |                                  |                    |                    |                    |
| 300 kHz to 3 MHz <sup>3</sup>  | < -83 dBm                    |                    |                    |                    | < -94 dBm                        |                    |                    |                    |
| 3 to 10 MHz  | < -103 dBm                   |                    |                    |                    | < -110 dBm                       |                    |                    |                    |
| 10 to 45 MHz   | < -112 dBm                   |                    |                    |                    | < -116 dBm                       | < -89 dBm          | < -80 dBm          | < -80 dBm          |
| 45 to 70 MHz   | < -112 dBm                   | < -96 dBm          | < -90 dBm          | < -90 dBm          | < -116 dBm                       |                    |                    |                    |
| 70 to 500 MHz  | < -112 dBm                   | < -100 dBm         | < -90 dBm          | < -90 dBm          | < -116 dBm                       |                    |                    |                    |
| 500 MHz to 2 GHz   | < -112 dBm                   | < -105 dBm         | < -110 dBm         | < -110 dBm         | < -120 dBm                       |                    |                    |                    |
| 2 to 4 GHz   | < -112 dBm                   | < -105 dBm         | < -110 dBm         | < -110 dBm         | < -120 dBm                       |                    |                    |                    |
| 4 to 8 GHz   | < -112 dBm                   | < -105 dBm         | < -110 dBm         | < -110 dBm         | < -119 dBm                       |                    |                    |                    |
| 8 to 10.5 GHz  | < -112 dBm                   | < -105 dBm         | < -100 dBm         | < -100 dBm         | < -119 dBm                       |                    |                    |                    |
| 10.5 to 13.5 GHz   | < -107 dBm                   | < -105 dBm         | < -100 dBm         | < -100 dBm         | < -114 dBm                       |                    |                    |                    |
| 13.5 to 20 GHz   | < -105 dBm                   |                    | < -100 dBm         | < -100 dBm         |                                  |                    |                    |                    |
| 20 to 31.25 GHz  |                              |                    | < -100 dBm         | < -100 dBm         |                                  |                    |                    |                    |
| 31.25 to 40 GHz  |                              |                    | < -95 dBm          | < -95 dBm          |                                  |                    |                    |                    |
| 40 to 50 GHz   |                              |                    | < -90 dBm          | < -90 dBm          |                                  |                    |                    |                    |
| <b>Test port noise floor<sup>1</sup> 1 KHz IF bandwidth</b>                                |                              |                    |                    |                    |                                  |                    |                    |                    |
| 300 kHz to 3 MHz <sup>3</sup>  | < -73 dBm                    |                    |                    |                    | < -83 dBm                        |                    |                    |                    |
| 3 to 10 MHz  | < -83 dBm                    |                    |                    |                    | < -90 dBm                        |                    |                    |                    |
| 10 to 45 MHz   | < -92 dBm                    |                    |                    |                    | < -96 dBm                        | < -69 dBm          | < -60 dBm          | < -60 dBm          |
| 45 to 70 MHz   | < -92 dBm                    | < -76 dBm          | < -70 dBm          | < -70 dBm          | < -96 dBm                        |                    |                    |                    |
| 70 to 500 MHz  | < -92 dBm                    | < -80 dBm          | < -70 dBm          | < -70 dBm          | < -96 dBm                        |                    |                    |                    |
| 500 MHz to 2 GHz   | < -92 dBm                    | < -85 dBm          | < -90 dBm          | < -90 dBm          | < -100 dBm                       |                    |                    |                    |
| 2 to 4 GHz   | < -92 dBm                    | < -85 dBm          | < -90 dBm          | < -90 dBm          | < -100 dBm                       |                    |                    |                    |
| 4 to 8 GHz   | < -92 dBm                    | < -85 dBm          | < -90 dBm          | < -90 dBm          | < -99 dBm                        |                    |                    |                    |
| 8 to 10.5 GHz  | < -92 dBm                    | < -85 dBm          | < -80 dBm          | < -80 dBm          | < -99 dBm                        |                    |                    |                    |
| 10.5 to 13.5 GHz   | < -87 dBm                    | < -85 dBm          | < -80 dBm          | < -80 dBm          | < -94 dBm                        |                    |                    |                    |
| 13.5 to 20 GHz   | < -85 dBm                    |                    | < -80 dBm          | < -80 dBm          |                                  |                    |                    |                    |
| 20 to 31.25 GHz  |                              |                    | < -80 dBm          | < -80 dBm          |                                  |                    |                    |                    |
| 31.25 to 40 GHz  |                              |                    | < -75 dBm          | < -75 dBm          |                                  |                    |                    |                    |
| 40 to 50 GHz   |                              |                    | < -70 dBm          | < -70 dBm          |                                  |                    |                    |                    |
| Description  | Specifications               |                    |                    |                    | Typicals                         |                    |                    |                    |
|  | Option<br>020, 125           | Option<br>225      | Option<br>425      | Option<br>525      | Option<br>020, 125               | Option<br>225      | Option<br>425      | Option<br>525      |
| <b>Direct receiver access input noise floor<sup>1</sup> 10 Hz IF bandwidth<sup>2</sup></b> |                              |                    |                    |                    |                                  |                    |                    |                    |
| 300 kHz to 3 MHz <sup>3</sup>  | < -99 dBm                    |                    |                    |                    |                                  |                    |                    |                    |
| 3 to 10 MHz  | < -119 dBm                   |                    |                    |                    |                                  |                    |                    |                    |
| 10 to 45 MHz   | < -128 dBm                   |                    |                    |                    | < -120 dBm < -126 dBm < -126 dBm |                    |                    |                    |
| 45 to 70 MHz   | < -128 dBm                   | < -108 dBm         | < -111 dBm         | < -111 dBm         |                                  |                    |                    |                    |
| 70 to 500 MHz  | < -128 dBm                   | < -112 dBm         | < -111 dBm         | < -111 dBm         |                                  |                    |                    |                    |
| 500 MHz to 2 GHz   | < -128 dBm                   | < -117 dBm         | < -122 dBm         | < -122 dBm         |                                  |                    |                    |                    |
| 2 to 8 GHz   | < -128 dBm                   | < -117 dBm         | < -122 dBm         | < -122 dBm         |                                  |                    |                    |                    |
| 8 to 10.5 GHz  | < -128 dBm                   | < -117 dBm         | < -112 dBm         | < -112 dBm         |                                  |                    |                    |                    |
| 10.5 to 13.5 GHz   | < -128 dBm                   | < -117 dBm         | < -112 dBm         | < -112 dBm         |                                  |                    |                    |                    |
| 13.5 to 20 GHz   | < -117 dBm                   |                    | < -112 dBm         | < -112 dBm         |                                  |                    |                    |                    |
| 20 to 31.25 GHz  |                              |                    | < -111 dBm         | < -111 dBm         |                                  |                    |                    |                    |
| 31.25 to 40 GHz  |                              |                    | < -106 dBm         | < -106 dBm         |                                  |                    |                    |                    |
| 40 to 50 GHz   |                              |                    | < -98 dBm          | < -98 dBm          |                                  |                    |                    |                    |
| <b>Direct receiver access input noise floor<sup>1</sup> 1 KHz IF bandwidth</b>             |                              |                    |                    |                    |                                  |                    |                    |                    |
| 300 kHz to 3 MHz <sup>3</sup>  | < -89 dBm                    |                    |                    |                    |                                  |                    |                    |                    |
| 3 to 10 MHz  | < -99 dBm                    |                    |                    |                    |                                  |                    |                    |                    |
| 10 to 45 MHz   | < -108 dBm                   |                    |                    |                    | < -100 dBm < -106 dBm < -106 dBm |                    |                    |                    |
| 45 to 70 MHz   | < -108 dBm                   | < -88 dBm          | < -91 dBm          | < -91 dBm          |                                  |                    |                    |                    |
| 70 to 500 MHz  | < -108 dBm                   | < -92 dBm          | < -91 dBm          | < -91 dBm          |                                  |                    |                    |                    |
| 500 MHz to 2 GHz   | < -108 dBm                   | < -97 dBm          | < -102 dBm         | < -102 dBm         |                                  |                    |                    |                    |
| 2 to 8 GHz   | < -108 dBm                   | < -97 dBm          | < -102 dBm         | < -102 dBm         |                                  |                    |                    |                    |
| 8 to 10.5 GHz  | < -108 dBm                   | < -97 dBm          | < -92 dBm          | < -92 dBm          |                                  |                    |                    |                    |
| 10.5 to 13.5 GHz   | < -108 dBm                   | < -97 dBm          | < -92 dBm          | < -92 dBm          |                                  |                    |                    |                    |
| 13.5 to 20 GHz   | < -97 dBm                    |                    | < -92 dBm          | < -92 dBm          |                                  |                    |                    |                    |
| 20 to 31.25 GHz  |                              |                    | < -91 dBm          | < -91 dBm          |                                  |                    |                    |                    |
| 31.25 to 40 GHz  |                              |                    | < -86 dBm          | < -86 dBm          |                                  |                    |                    |                    |
| 40 to 50 GHz   |                              |                    | < -78 dBm          | < -78 dBm          |                                  |                    |                    |                    |

1. Total average (rms) noise power calculated as the mean value of a linear magnitude trace expressed in dBm.

2. 10 Hz IFBW test port noise floor performance is mathematically derived from the 1 kHz IFBW noise floor performance. The performance could be limited by crosstalk below 3 MHz at certain frequencies. The measurement is defined as a single receiver measurement with loads on the ports at a given CW frequency with power set to the minimum plus 5 dB.

3. Value and/or frequency changed July 2006.

Table 11: Test port input (Continued)

| Description               | Specifications  |             |                 |             |                 |             | Typicals        |             |
|---------------------------|-----------------|-------------|-----------------|-------------|-----------------|-------------|-----------------|-------------|
|                           | Option 220, 225 |             | Option 420, 520 |             | Option 425, 525 |             | Option 220, 225 |             |
| Compression level         | Power           | Compression | Power           | Compression | Power           | Compression | Power           | Compression |
| 10 to 45 MHz <sup>2</sup> |                 |             |                 |             |                 |             | +5 dBm          | 0.10 dB     |
| 45 to 500 MHz             | +5 dBm          | 0.10 dB     | +5 dBm          | 0.40 dB     | +5 dBm          | 0.40 dB     |                 |             |
| 500 MHz to 2 GHz          | +5 dBm          | 0.15 dB     | +5 dBm          | 0.77 dB     | +5 dBm          | 0.67 dB     |                 |             |
| 2 to 8 GHz                | +5 dBm          | 0.21 dB     | +5 dBm          | 0.75 dB     | +5 dBm          | 0.55 dB     |                 |             |
| 8 to 12.5 GHz             | +5 dBm          | 0.21 dB     | +5 dBm          | 0.56 dB     | +5 dBm          | 0.51 dB     |                 |             |
| 12.5 to 20 GHz            | +3 dBm          | 0.20 dB     | +5 dBm          | 0.79 dB     | +5 dBm          | 0.69 dB     |                 |             |
| 20 to 31.25 GHz           |                 |             | 0 dBm           | 0.60 dB     | 0 dBm           | 0.50 dB     |                 |             |
| 31.25 to 40 GHz           |                 |             | -3 dBm          | 0.55 dB     | -3 dBm          | 0.60 dB     |                 |             |
| 40 to 50 GHz              |                 |             | -3 dBm          | 0.66 dB     | -3 dBm          | 0.71 dB     |                 |             |

| Description       | Specifications            |             | Typicals         |
|-------------------|---------------------------|-------------|------------------|
|                   | Option 020, 120, 025, 125 |             |                  |
| Compression level | Power                     | Compression |                  |
| 300 kHz to 10 MHz | +8 dBm                    | 1.0 dB      | 0.1 dB at +5 dBm |
| 10 to 50 MHz      | +8 dBm                    | 0.35 dB     |                  |
| 50 MHz to 1 GHz   | +8 dBm                    | 0.35 dB     |                  |
| 1 to 6 GHz        | +8 dBm                    | 0.25 dB     |                  |
| 6 to 8 GHz        | +8 dBm                    | 0.25 dB     |                  |
| 8 to 12.5 GHz     | +8 dBm                    | 0.30 dB     |                  |
| 12.5 to 13.5 GHz  | +8 dBm                    | 0.40 dB     |                  |

| Description                | Specifications            |             | Typicals |
|----------------------------|---------------------------|-------------|----------|
|                            | Option 020, 120, 025, 125 |             |          |
| Compression level - 0.1 dB | Power                     | Compression |          |
| 300 kHz to 10 MHz          | +5 dBm                    | 0.1 dB      |          |
| 10 MHz to 1 GHz            | +9 dBm                    | 0.1 dB      |          |
| 1 to 12.5 GHz              | +10 dBm                   | 0.1 dB      |          |
| 12.5 to 13.5 GHz           | +9 dBm                    | 0.1 dB      |          |

| Description                    | Specifications  |                 |                 | Typicals   |            |                 |                 |
|--------------------------------|-----------------|-----------------|-----------------|------------|------------|-----------------|-----------------|
|                                | Option 220, 225 | Option 420, 425 | Option 520, 525 | Option 220 | Option 225 | Option 420, 425 | Option 520, 525 |
| Test port compression - 0.1 dB |                 |                 |                 |            |            |                 |                 |
| 300 kHz to 10 MHz              |                 |                 |                 |            |            |                 |                 |
| 10 to 45 MHz <sup>2</sup>      |                 |                 |                 | +10 dBm    | negligible | negligible      | negligible      |
| 45 to 500 MHz                  |                 |                 |                 | +10 dBm    | +10 dBm    | 0.0 dBm         | +1.0 dBm        |
| 500 MHz to 2 GHz               |                 |                 |                 | +9 dBm     | +9 dBm     | 0.0 dBm         | +1.0 dBm        |
| 2 to 12.5 GHz                  |                 |                 |                 | +6 dBm     | +6 dBm     | 0.0 dBm         | +1.5 dBm        |
| 12.5 to 13.5 GHz               |                 |                 |                 | +6 dBm     | +6 dBm     | -1.0 dBm        | 0.0 dBm         |
| 13.5 to 20 GHz                 |                 |                 |                 | +6 dBm     | +6 dBm     | -1.0 dBm        | 0.0 dBm         |
| 20 to 31.25 GHz                |                 |                 |                 |            |            | -5.5 dBm        | -3.0 dBm        |
| 31.25 to 40 GHz                |                 |                 |                 |            |            | -8.5 dBm        | -7.5 dBm        |
| 40 to 50 GHz                   |                 |                 |                 |            |            |                 | -10.0 dBm       |

**Trace noise magnitude<sup>3</sup>**

**1 kHz IF bandwidth**, ratioed measurement, nominal power at test port.

| 300 kHz to 10 MHz |              |              |              |
|-------------------|--------------|--------------|--------------|
| 10 to 45 MHz      | 0.004 dB rms | 0.010 dB rms | 0.010 dB rms |
| 45 to 500 MHz     | 0.004 dB rms | 0.006 dB rms | 0.006 dB rms |
| 500 MHz to 2 GHz  | 0.004 dB rms | 0.006 dB rms | 0.006 dB rms |
| 2 to 10.5 GHz     | 0.006 dB rms | 0.010 dB rms | 0.010 dB rms |
| 10.5 to 13.5 GHz  | 0.006 dB rms | 0.010 dB rms | 0.010 dB rms |
| 13.5 to 20 GHz    | 0.006 dB rms | 0.010 dB rms | 0.010 dB rms |
| 20 to 31.25 GHz   |              | 0.010 dB rms | 0.010 dB rms |
| 31.25 to 40 GHz   |              | 0.020 dB rms | 0.020 dB rms |
| 40 to 50 GHz      |              | 0.020 dB rms |              |

1. Total average (rms) noise power calculated as the mean value of a linear magnitude trace expressed in dBm.
2. For Options 225, 420, 425, 520, and 525 coupler roll-off will reduce compression to a negligible level below 45 MHz.
3. 1 kHz IF BW, ratioed measurement, nominal power at the test port.
4. Stability is defined as a ratio measurement made at the test port.

Table 11: Test port input (Continued)

| Description  | Specifications            |  | Typicals                  |
|--|---------------------------|--|---------------------------|
|  | Option 020, 120, 025, 125 |  | Option 020, 120, 025, 125 |
| <b>Trace noise magnitude<sup>3</sup></b> (continued)                           |                           |  |                           |
| <b>100 kHz IF bandwidth</b> , ratioed measurement, nominal power at test port. |                           |  |                           |
| 300 kHz to 10 MHz  | 12 mdB                    |  |                           |
| 10 MHz to 6 GHz  | 4 mdB                     |  |                           |
| 6 to 10.5 GHz  | 4 mdB                     |  |                           |
| 10.5 to 13.5 GHz   | 8 mdB                     |  |                           |
| <b>600 kHz IF bandwidth</b> , ratioed measurement, nominal power at test port. |                           |  |                           |
| 300 kHz to 10 MHz  |                           |  | 20 mdB                    |
| 10 MHz to 6 GHz  |                           |  | 8 mdB                     |
| 6 to 10.5 GHz  |                           |  | 8 mdB                     |
| 10.5 to 13.5 GHz   |                           |  | 10 mdB                    |

| Description  | Specifications  |                 |                 | Typicals        |                 |                 |
|--|-----------------|-----------------|-----------------|-----------------|-----------------|-----------------|
|  | Option 220, 225 | Option 420, 425 | Option 520, 525 | Option 220, 225 | Option 420, 425 | Option 520, 525 |
| <b>Trace noise phase<sup>3</sup></b>   |                 |                 |                 |                 |                 |                 |
| <b>1 kHz IF bandwidth</b> , ratioed measurement, nominal power at test port. |                 |                 |                 |                 |                 |                 |
| 300 kHz to 10 MHz  |                 |                 |                 |                 |                 |                 |
| 10 to 45 MHz   |                 |                 |                 | 0.025° rms      | 0.100° rms      | 0.100° rms      |
| 45 to 500 MHz  | 0.060° rms      | 0.100° rms      | 0.100° rms      |                 |                 |                 |
| 500 MHz to 2 GHz   | 0.060° rms      | 0.060° rms      | 0.060° rms      |                 |                 |                 |
| 2 to 10.5 GHz  | 0.060° rms      | 0.060° rms      | 0.060° rms      |                 |                 |                 |
| 10.5 to 13.5 GHz   | 0.060° rms      | 0.100° rms      | 0.100° rms      |                 |                 |                 |
| 13.5 to 20 GHz   | 0.060° rms      | 0.100° rms      | 0.100° rms      |                 |                 |                 |
| 20 to 31.25 GHz  |                 | 0.100° rms      | 0.100° rms      |                 |                 |                 |
| 31.25 to 40 GHz  |                 | 0.200° rms      | 0.200° rms      |                 |                 |                 |
| 40 to 50 GHz   |                 |                 | 0.200° rms      |                 |                 |                 |

| Description  | Specifications            |  | Typicals                  |
|--|---------------------------|--|---------------------------|
|  | Option 020, 120, 025, 125 |  | Option 020, 120, 025, 125 |
| <b>Trace noise phase<sup>3</sup></b>   |                           |  |                           |
| <b>100 kHz IF bandwidth</b> , ratioed measurement, nominal power at test port. |                           |  |                           |
| 300 kHz to 10 MHz  | 80 mdeg                   |  |                           |
| 10 MHz to 6 GHz  | 30 mdeg                   |  |                           |
| 6 to 10.5 GHz  | 30 mdeg                   |  |                           |
| 10.5 to 13.5 GHz   | 60 mdeg                   |  |                           |
| <b>600 kHz IF bandwidth</b> , ratioed measurement, nominal power at test port. |                           |  |                           |
| 300 kHz to 10 MHz  |                           |  | 100 mdeg                  |
| 10 MHz to 6 GHz  |                           |  | 60 mdeg                   |
| 6 to 10.5 GHz  |                           |  | 60 mdeg                   |
| 10.5 to 13.5 GHz   |                           |  | 80 mdeg                   |

| Description                      | Specifications  |  | Typicals  |
|----------------------------------|---|--|---|
|                                  | Option 020, 025, 120, 125, 220, 225, 420, 425, 520, 525 |  | Option 020, 025, 120, 125, 220, 225, 420, 425, 520, 525 |
| <b>Reference level magnitude</b> |   |  |   |
| Range                            | ±200 dB   |  |   |
| Resolution                       | 0.001 dB  |  |   |
| <b>Reference level phase</b>     |   |  |   |
| Range                            | ±500°   |  |   |
| Resolution                       | 0.01°   |  |   |

1. Total average (rms) noise power calculated as the mean value of a linear magnitude trace expressed in dBm.
2. For Options 225, 420, 425, 520, and 525 coupler roll-off will reduce compression to a negligible level below 45 MHz.
3. 1 kHz IF BW, ratioed measurement, nominal power at the test port.
4. Stability is defined as a ratio measurement made at the test port.

Table 11: Test port input (Continued)

| Description                            | Specifications               |                    |                              | Typicals                     |                    |                              |
|--|------------------------------|--------------------|------------------------------|------------------------------|--------------------|------------------------------|
|  | Option<br>020, 025, 120, 125 | Option<br>220, 225 | Option<br>420, 425, 520, 525 | Option<br>020, 025, 120, 125 | Option<br>220, 225 | Option<br>420, 425, 520, 525 |
| <b>Stability magnitude<sup>4</sup></b> |                              |                    |                              |                              |                    |                              |
| 300 kHz to 10 MHz                      |                              |                    |                              | ±0.015 dB/°C                 |                    |                              |
| 10 to 45 MHz                           |                              |                    |                              | ±0.010 dB/°C                 | ±0.015 dB/°C       | ±0.015 dB/°C                 |
| 45 to 500 MHz                          |                              |                    |                              | ±0.010 dB/°C                 | ±0.010 dB/°C       | ±0.010 dB/°C                 |
| 500 MHz to 2 GHz                       |                              |                    |                              | ±0.010 dB/°C                 | ±0.010 dB/°C       | ±0.010 dB/°C                 |
| 2 to 4 GHz                             |                              |                    |                              | ±0.015 dB/°C                 | ±0.020 dB/°C       | ±0.010 dB/°C                 |
| 4 to 8 GHz                             |                              |                    |                              | ±0.020 dB/°C                 | ±0.020 dB/°C       | ±0.010 dB/°C                 |
| 8 to 13.5 GHz                          |                              |                    |                              | ±0.020 dB/°C                 | ±0.030 dB/°C       | ±0.015 dB/°C                 |
| 13.5 to 20 GHz                         |                              |                    |                              |                              | ±0.030 dB/°C       | ±0.015 dB/°C                 |
| 20 to 40 GHz                           |                              |                    |                              |                              |                    | ±0.040 dB/°C                 |
| 40 to 50 GHz                           |                              |                    |                              |                              |                    | ±0.060 dB/°C                 |
| <b>Stability phase<sup>4</sup></b>     |                              |                    |                              |                              |                    |                              |
| 300 kHz to 10 MHz                      |                              |                    |                              | ±0.30°/°C                    |                    |                              |
| 10 to 45 MHz                           |                              |                    |                              | ±0.025°/°C                   | ±0.25°/°C          | ±0.25°/°C                    |
| 45 to 500 MHz                          |                              |                    |                              | ±0.035°/°C                   | ±0.20°/°C          | ±0.22°/°C                    |
| 500 MHz to 2 GHz                       |                              |                    |                              | ±0.050°/°C                   | ±0.15°/°C          | ±0.22°/°C                    |
| 2 to 4 GHz                             |                              |                    |                              | ±0.10°/°C                    | ±0.15°/°C          | ±0.10°/°C                    |
| 4 to 8 GHz                             |                              |                    |                              | ±0.15°/°C                    | ±0.15°/°C          | ±0.10°/°C                    |
| 8 to 13.5 GHz                          |                              |                    |                              | ±0.30°/°C                    | ±0.45°/°C          | ±0.15°/°C                    |
| 13.5 to 20 GHz                         |                              |                    |                              |                              | ±0.45°/°C          | ±0.15°/°C                    |
| 20 to 40 GHz                           |                              |                    |                              |                              |                    | ±0.40°/°C                    |
| 40 to 50 GHz                           |                              |                    |                              |                              |                    | ±0.40°/°C                    |

| Description               | Specifications        |                       | Typicals              |                       |                         |  |
|---------------------------|-----------------------|-----------------------|-----------------------|-----------------------|-------------------------|--|
|                           | Option<br>020, 120    | Option<br>220         | Option<br>420, 520    | Option<br>025, 125    | Option<br>225, 425, 525 |  |
| <b>Damage input level</b> |                       |                       |                       |                       |                         |  |
| Test port 1 and 2         | +27 dBm or<br>±16 VDC | +30 dBm or<br>±25 VDC | +30 dBm or<br>±40 VDC | +27 dBm or<br>±16 VDC | +27 dBm or<br>±7 VDC    |  |
| R1, R2 in                 |                       |                       |                       | +15 dBm or<br>±16 VDC | +15 dBm or<br>±7 VDC    |  |
| A, B in                   |                       |                       |                       | +15 dBm or<br>±16 VDC | +15 dBm or<br>±7 VDC    |  |
| Coupler thru              |                       |                       |                       | +27 dBm or<br>±16 VDC | +30 dBm or<br>±40 VDC   |  |
| Coupler arm               |                       |                       |                       | +15 dBm or<br>±0 VDC  | +30 dBm or<br>±7 VDC    |  |
| Source out (reference)    |                       |                       |                       | +20 dBm or<br>±16 VDC | +20 dBm or<br>±7 VDC    |  |
| Source out (test ports)   |                       |                       |                       | +27 dBm or<br>±16 VDC | +30 dBm or<br>±7 VDC    |  |

1. Total average (rms) noise power calculated as the mean value of a linear magnitude trace expressed in dBm.
2. For Options 225, 420, 425, 520, and 525 coupler roll-off will reduce compression to a negligible level below 45 MHz.
3. 1 kHz IF BW, ratioed measurement, nominal power at the test port.
4. Stability is defined as a ratio measurement made at the test port.

## Dynamic Accuracy

Note: Dynamic accuracy uncertainty curves are available within the PNA-L network analyzer's internal Help system. The Help system is also available online at [www.agilent.com](http://www.agilent.com). Navigate to the home page for your PNA model, then click on manuals & guides. Please download our free uncertainty calculator from [www.agilent.com/find/na\\_calculator](http://www.agilent.com/find/na_calculator) to generate the curves for your calibration kit and PNA setup.

Table 12. Test port input (group delay)<sup>1</sup>

| Description           | Specification | Supplemental information (typ.)  |
|-----------------------|---------------|--|
| Aperture (selectable) |               | (frequency span)/(number of points -1)   |
| Maximum aperture      |               | 20% of frequency span  |
| Range                 |               | 0.5 x (1/minimum aperture)   |
| Maximum delay         |               | Limited to measuring no more than 180° of phase change within the minimum aperture |
| Accuracy              |               | See graph below. Char.   |

The following graph shows characteristic group delay accuracy with full 2-port calibration and a 10 Hz IF bandwidth. Insertion loss is assumed to be < 2 dB and electrical length to be ten meters.

### Group delay (typical)

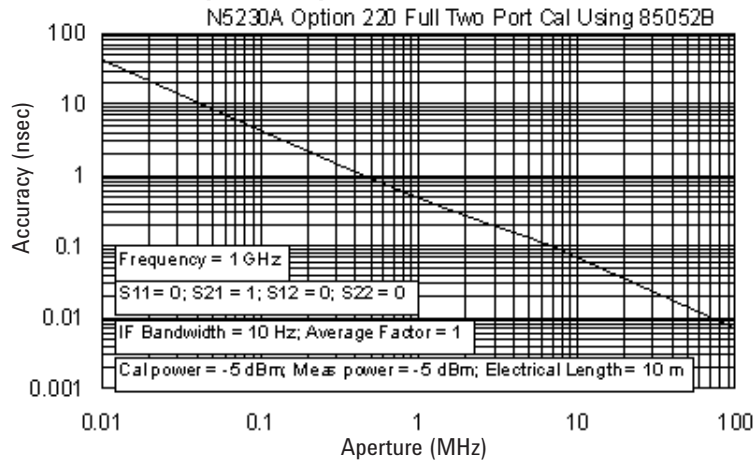

In general, the following formula can be used to determine the accuracy, in seconds, of specific group delay measurement:

$$\pm \text{Phase Accuracy (deg)} / [360^\circ \text{ Aperture (Hz)}]$$

Depending on the aperture and device length, the phase accuracy used is either incremental phase accuracy or worst case phase accuracy.

1. Group delay is computed by measuring the phase change within a specified frequency step (determined by the frequency span and the number of points per sweep).

## General Information

**Table 13. Miscellaneous information**

| Description                      | Supplemental information  |
|----------------------------------|---|
| <b>System IF bandwidth range</b> | Option 020, 025, 120, 125                      1 Hz to 600 kHz, nominal |
|                                  | Option 220, 225, 420, 425, 520, 525            1 Hz to 250 kHz, nominal |
| <b>CPU</b>                       | Intel® 1.1 GHz Pentium® M with 1 GByte RAM                              |

**Table 14. Front panel information**

| Description               | Supplemental information  |
|---------------------------|---|
| <b>RF connectors</b>      |   |
| <b>N5230A</b>             |   |
| Type                      | Option 020, 025, 120, 125, 220 or 225: 3.5 mm (male), 50 ohm, (nominal)<br>Option 420, 425, 520, or 525: 2.4 mm (male), 50 ohm, (nominal)   |
| Center pin recession      | 0.002 in. (characteristic)  |
| <b>Display</b>            |   |
| Size                      | 21.3 cm (8.4 in) diagonal color active matrix LCD;<br>640 (horizontal) X 480 (vertical) resolution  |
| Refresh rate              | Vertical 59.83 Hz; Horizontal 31.41 kHz   |
| Pixels                    | A display is considered faulty if: <ul style="list-style-type: none"> <li>• A complete row or column of "stuck" or "dark" pixels.</li> <li>• More than six "stuck on" pixels (but not more than three green) or more than 0.002% of the total pixels are within the LCD specifications.</li> <li>• More than twelve "dark" pixels (but no more than seven of the same color) or more than 0.004% of the total pixels are within the LCD specifications.</li> <li>• Two or more consecutive "stuck on" pixels or three or more consecutive "dark" pixel (but no more than one set of two consecutive dark pixels) "Stuck on" of "dark" pixels less than 6.5 mm apart (excluding consecutive pixels)</li> </ul> |
| Display range             | The PNA display must remain in the 16-bit color setting in order to comply with international emissions regulations   |
| Magnitude                 | ±500 dB (at 20 dB/div), max   |
| Phase                     | ±500°, max  |
| Polar                     | 10 pUnits, min<br>1000 Units, max   |
| <b>Display resolution</b> |   |
| Magnitude                 | 0.001 dB/div, min   |
| Phase                     | 0.01°/div, min  |
| <b>Marker resolution</b>  |   |
| Magnitude                 | 0.001 dB, min   |
| Phase                     | 0.01°, min  |
| Polar                     | 0.01 mUnit, min; 0.01°, min   |

1. Any PNA Service Guide contains instructions for running the analyzer's built-in Display Test". You can view a PDF file of a Service Guide on the Web at [www.agilent.com/find/pna](http://www.agilent.com/find/pna). After opening the PDF file, look in the left-side column and then click on the "Index" bookmark. From the index, click on "Display Test".

**Table 15. Rear panel information**

| <b>Description</b>               | <b>Supplemental information</b>   |
|----------------------------------|---|
| <b>Trigger inputs/outputs</b>    | <b>BNC (f), TTL/CMOS compatible</b>   |
| <b>10 MHz Reference in</b>       |   |
| Connector                        | BNC, female   |
| Input frequency                  | 10 MHz $\pm$ 10 ppm, typical  |
| Input level                      | -15 to +20 dBm, typical   |
| Input impedance                  | 200 $\Omega$ , nom.   |
| <b>10 MHz Reference out</b>      |   |
| Connector                        | BNC, female   |
| Output frequency                 | 10 MHz $\pm$ 1 ppm, typical   |
| Signal type                      | Sine Wave, typical  |
| Output level                     | +10 dBm $\pm$ 4 dB into 50 W, typical   |
| Output impedance                 | 50 $\Omega$ , nominal   |
| Harmonics                        | < -40 dBc, typical  |
| <b>VGA Video output</b>          |   |
| Connector                        | 15-pin mini D-Sub; Drives VGA compatible monitors   |
| <b>Test set IO</b>               |   |
|                                  | 25-pin D-Sub connector, available for external test set control   |
| <b>Aux IO</b>                    |   |
|                                  | 25-pin D-Sub connector, male, analog and digital I/O  |
| <b>Handler IO</b>                |   |
|                                  | 36-pin parallel I/O port; all input/output signals are default set to negative logic; can be reset to positive logic via GPIB command |
| <b>GPIB</b>                      |   |
|                                  | Two ports: dedicated Controller and dedicated Talker/Listener.<br>24-pin D-sub (Type D-24), female; compatible with IEEE-488.         |
| <b>USB Port</b>                  |   |
|                                  | 1 port on front panel and 4 ports on rear panel.  |
| <b>LAN</b>                       |   |
|                                  | 10/100BaseT Ethernet, 8-pin configuration; auto selects between the two data rates  |
| <b>Line power (single phase)</b> |   |
| Frequency, voltage               | 50/60 Hz/400 Hz for 100 to 120V, 50/60 Hz for 220 to 240 V,<br>(power supply is auto switching)                                       |
| Maximum                          | 350 Watts   |

**Note:** Option H08 and Option H11 specifications are not provided in this N5230A specifications document.

**Table 16. Analyzer environment and dimensions**

| <b>Description</b>  | <b>Supplemental information</b>  |
|---|--|
| <b>General environmental</b>  |  |
| EMC   | Complies with European EMC directive 89/336/EEC, amended by 93/68/EEC <ul style="list-style-type: none"> <li>• IEC/EN 61326</li> <li>• CISPR Pub 11 Group 1, class A</li> <li>• AS/NZS CISPR II:2002</li> <li>• ICES/NMB-001</li> </ul>              |
| Safety  | Complies with European Low Voltage Directive 73/23/EEC, amended by 93/68/EEC <ul style="list-style-type: none"> <li>• IEC/EN 61010-1:2001</li> <li>• Canada: CSA C22.2 No. 61010-1:2001</li> <li>• USA: UL 61010-1</li> </ul>                        |
| <b>Operating environment</b>  |  |
| Temperature   | 0 to +40 °C<br><br>Instrument powers up and displays no error messages within this temperature range (except for "source unlevelled" error message that may occur at temperatures outside the specified performance temperature range of 25 ± 5 °C). |
| Error-corrected temperature range   | 23 °C ± 3 °C with less than 1 °C deviation from calibration temp.  |
| Relative humidity   | Type-tested 0 to 95% at 40 °C, non-condensing  |
| Altitude  | 0 to 4600 m (15,000 ft.)   |
| <b>Non-operating storage environment</b>                                    |  |
| Temperature   | -40 to +70 °C  |
| <b>Cabinet dimensions</b>   |  |
|   | <b>Height    Width    Depth</b>  |
| Excluding front and rear panel hardware and feet                            | 267 mm    426 mm    427 mm<br>10.5 in    16.75    16.8 in  |
| As shipped - includes front panel connectors, rear panel bumpers, and feet. | 280 mm    435 mm    470 mm<br>11 in    17.10 in    18.5 in   |
| As shipped plus handles   | 280 mm    458 mm    501 mm<br>11 in    18 in    19.7 in  |
| As shipped plus rack-mount flanges  | 280 mm    483 mm    470 mm<br>11 in    19 in    18.5 in  |
| As shipped plus handles and rack-mount flanges                              | 280 mm    483 mm    501 mm<br>11 in    19 in    19.7 in  |
| <b>Weight</b>   |  |
| Net   |  |
| N5230A  | 24.9 kg (55 lb), nominal   |
| Shipping  |  |
| N5230A  | 36.3 kg (80 lb), nominal   |

# N5230A

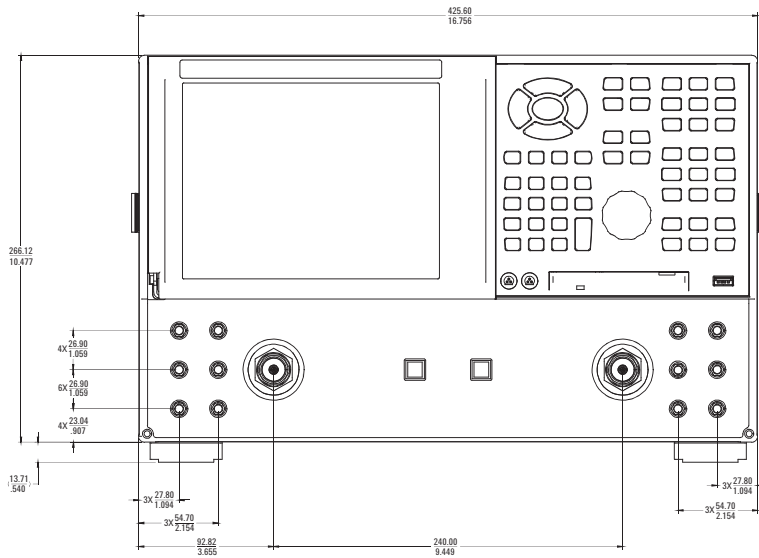

## Measurement Throughput Summary

Table 17. Typical cycle time<sup>1,2</sup> (ms) for measurement completion

|   | Number of Points |       |       |       |        |
|---|------------------|-------|-------|-------|--------|
|   | 201              | 401   | 801   | 1601  | 16,001 |
| <b>Start 8 GHz, stop 18 GHz, 30 kHz IF bandwidth</b>  |                  |       |       |       |        |
| Uncorrected   | 97.5             | 102.7 | 103.8 | 108.2 | 683.9  |
| 2-Port cal  | 203.7            | 213.5 | 218.5 | 234.6 | 1504.3 |
| <b>Start 10 MHz, stop 10 GHz, 30 kHz IF bandwidth</b> |                  |       |       |       |        |
| Uncorrected   | 112.6            | 120.6 | 124.8 | 138.2 | 738.4  |
| 2-Port cal  | 232.8            | 251.8 | 265.2 | 304.3 | 1623.4 |
| <b>Start 10 MHz, stop 20 GHz, 30 kHz IF bandwidth</b> |                  |       |       |       |        |
| Uncorrected   | 146              | 199.3 | 210.9 | 217.2 | 753.9  |
| 2-Port cal  | 302.3            | 410.5 | 438.7 | 462.5 | 1660.5 |
| <b>Start 8 GHz, stop 18 GHz, 50 kHz IF bandwidth</b>  |                  |       |       |       |        |
| Uncorrected   | 79.1             | 81    | 81.7  | 86.6  | 482    |
| 2-Port cal  | 164.5            | 170.3 | 175.3 | 193.5 | 1104.7 |
| <b>Start 10 MHz, stop 10 GHz, 50 kHz IF bandwidth</b> |                  |       |       |       |        |
| Uncorrected   | 96.8             | 101.7 | 108.8 | 122.2 | 524.6  |
| 2-Port cal  | 202.1            | 215.6 | 236.7 | 276.7 | 1198.8 |
| <b>Start 10 MHz, stop 20 GHz, 50 kHz IF bandwidth</b> |                  |       |       |       |        |
| Uncorrected   | 141.6            | 163.9 | 170.7 | 179.7 | 546.5  |
| 2-Port cal  | 293.6            | 341   | 360   | 389.5 | 1248.8 |

1. Typical performance.
2. Includes sweep time, retrace time and band-crossing time. Analyzer display turned off with DISPLAY:ENABLE OFF. Add 21 ms for display on. Data for one trace (S11) measurement.

**Table 18. Cycle Time vs IF bandwidth<sup>1</sup> (Options 020, 025, 120, 125 only)**

Applies to the preset condition (201 points, correction off) except for the following changes:

- CF = 10 GHz
- Span = 100 MHz
- Display off (add 21 ms for display on)

| Description       |                              | Typical performance  |
|-------------------|------------------------------|----------------------|
| IF Bandwidth (Hz) | Cycle time (ms) <sup>2</sup> | Trace noise (dB rms) |
| 600,000           | 7                            | 0.0035               |
| 360,000           | 7                            | 0.0026               |
| 280,000           | 7                            | 0.0022               |
| 200,000           | 7                            | 0.0021               |
| 150,000           | 7                            | 0.0016               |
| 100,000           | 7                            | 0.0012               |
| 70,000            | 7                            | 0.0011               |
| 50,000            | 9                            | 0.0009               |
| 30,000            | 11                           | 0.0008               |
| 20,000            | 14                           | 0.0006               |
| 15,000            | 17                           | 0.0005               |
| 10,000            | 28                           | 0.0004               |
| 7,000             | 37                           | 0.0004               |
| 5,000             | 48                           | 0.0003               |
| 3,000             | 72                           | 0.0003               |
| 2,000             | 102                          | 0.0002               |
| 1,500             | 130                          | 0.0001               |
| 1,000             | 218                          | 0.0001               |
| 700               | 294                          | 0.0001               |
| 500               | 399                          | 0.0001               |
| 300               | 636                          | 0.0001               |
| 200               | 932                          | negligible           |
| 100               | 1,826                        | negligible           |
| 30                | 6,004                        | negligible           |
| 10                | 17,903                       | negligible           |
| 1                 | 178,398                      | negligible           |

1. Typical performance.
2. Cycle time includes sweep and retrace time.

**Table 21. Cycle time vs number of points<sup>1</sup> (Options 220, 225, 420, 425, 520, 525 only)**

**Table 19. Cycle Time vs IF bandwidth<sup>1</sup> (Options 220, 225, 420, 425, 520, 525 only)**

Applies to the preset condition (201 points, correction off) except for the following changes:

- CF = 10 GHz
- Span = 100 MHz
- Display off (add 21 ms for display on)

| <b>Description</b>       |                                    | <b>Typical performance</b>                |
|--------------------------|------------------------------------|---|
| <b>IF Bandwidth (Hz)</b> | <b>Cycle time (ms)<sup>2</sup></b> | <b>Cycle time (ms) Option 080 enabled</b> |
| 250,000                  | 8                                  | 37  |
| 200,000                  | 9                                  | 39  |
| 150,000                  | 9                                  | 40  |
| 100,000                  | 10                                 | 41  |
| 70,000                   | 11                                 | 43  |
| 50,000                   | 12                                 | 45  |
| 30,000                   | 15                                 | 50  |
| 20,000                   | 18                                 | 53  |
| 15,000                   | 21                                 | 57  |
| 10,000                   | 27                                 | 65  |
| 7,000                    | 34                                 | 75  |
| 5,000                    | 48                                 | 93  |
| 3,000                    | 72                                 | 124                                       |
| 2,000                    | 108                                | 169                                       |
| 1,500                    | 126                                | 187                                       |
| 1,000                    | 272                                |   |
| 700                      | 357                                |   |
| 500                      | 460                                |   |
| 300                      | 697                                |   |
| 200                      | 1003                               |   |
| 150                      | 1307                               |   |
| 100                      | 1917                               |   |
| 30                       | 6173                               |   |
| 10                       | 18214                              |   |
| 1                        | 181699                             |   |

1. Typical performance.
2. Cycle time includes sweep and retrace time.

**Table 20. Cycle time vs number of points<sup>1</sup> (Options 020, 025, 120, 125 only)**

Applies to the preset condition (201 points, correction off) except for the following changes:

- CF = 10 GHz
- Span = 100 MHz
- Display off (add 21 ms for display on)

| <b>Description</b>       |                         | <b>Typical performance</b>         |
|--------------------------|-------------------------|------------------------------------|
| <b>IF Bandwidth (Hz)</b> | <b>Number of points</b> | <b>Cycle time (ms)<sup>2</sup></b> |
| 30,000                   | 3                       | 6                                  |
|                          | 11                      | 7                                  |
|                          | 51                      | 6                                  |
|                          | 101                     | 7                                  |
|                          | 201                     | 11                                 |
|                          | 401                     | 18                                 |
|                          | 801                     | 32                                 |
|                          | 1,601                   | 59                                 |
|                          | 6,401                   | 224                                |
|                          | 16,001                  | 556                                |
| 300,000                  | 3                       | 6                                  |
|                          | 11                      | 6                                  |
|                          | 51                      | 6                                  |
|                          | 101                     | 7                                  |
|                          | 201                     | 7                                  |
|                          | 401                     | 9                                  |
|                          | 801                     | 13                                 |
|                          | 1,601                   | 22                                 |
|                          | 6,401                   | 75                                 |
|                          | 16,001                  | 180                                |
| 600,000                  | 3                       | 6                                  |
|                          | 11                      | 6                                  |
|                          | 51                      | 6                                  |
|                          | 101                     | 6                                  |
|                          | 201                     | 7                                  |
|                          | 401                     | 8                                  |
|                          | 801                     | 9                                  |
|                          | 1,601                   | 12                                 |
|                          | 6,401                   | 27                                 |
|                          | 16,001                  | 59                                 |

1. Typical performance.
2. Cycle time includes sweep and retrace time.

Applies to the preset condition (correction off) except for the following changes:

- CF = 10 GHz
- Span = 100 MHz
- Display off (add 21 ms for display on)

| IF Bandwidth (Hz) | Number of points | Cycle time (ms) <sup>2</sup> |
|-------------------|------------------|------------------------------|
| 30,000            | 3                | 8                            |
|                   | 11               | 8                            |
|                   | 51               | 9                            |
|                   | 101              | 11                           |
|                   | 201              | 15                           |
|                   | 401              | 23                           |
|                   | 801              | 39                           |
|                   | 1,601            | 71                           |
|                   | 6,401            | 265                          |
| 16,001            | 650              |                              |
| 50,000            | 3                | 7                            |
|                   | 11               | 7                            |
|                   | 51               | 8                            |
|                   | 101              | 10                           |
|                   | 201              | 13                           |
|                   | 401              | 18                           |
|                   | 801              | 29                           |
|                   | 1,601            | 52                           |
|                   | 6,401            | 184                          |
| 16,001            | 448              |                              |
| 250,000           | 101              | 8                            |
|                   | 201              | 9                            |
|                   | 401              | 10                           |
|                   | 801              | 14                           |
|                   | 1,601            | 21                           |
|                   | 6,401            | 61                           |
| 16,001            | 147              |                              |

1. Typical performance.
2. Cycle time includes sweep and retrace time.

**Note:** Specifications for recall and sweep speed are not provided for the N5230A analyzers.

**Table 22. Data transfer time (ms)<sup>1</sup>**

|   | <b>Number of points</b> |     |      |        |
|---|-------------------------|-----|------|--------|
|   | 201                     | 401 | 1601 | 16,001 |
| <b>SCPI over GPIB (program executed on external PC)</b> |                         |     |      |        |
| 32-bit floating point                                   | 7                       | 12  | 43   | 435    |
| 64-bit floating point                                   | 12                      | 22  | 84   | 856    |
| ASCII   | 64                      | 124 | 489  | 5054   |
| <b>SCPI (program executed in the analyzer)</b>          |                         |     |      |        |
| 32-bit floating point                                   | 1                       | 2   | 3    | 30     |
| 64-bit floating point                                   | 2                       | 2   | 4    | 40     |
| ASCII   | 29                      | 56  | 222  | 2220   |
| <b>COM (program executed in the analyzer)</b>           |                         |     |      |        |
| 32-bit floating point                                   | < 0.4                   | 0.4 | 0.5  | 1.9    |
| Variant type  | 0.7                     | 1   | 3    | 32     |
| <b>DCOM over LAN (program executed on external PC)</b>  |                         |     |      |        |
| 32-bit floating point                                   | < 0.8                   | 1   | 1.5  | 7.1    |
| Variant type  | 1.8                     | 2.7 | 8.5  | 80     |

1. Typical performance.

**Note:** Specifications for recall and sweep speed are not provided for the N5230A analyzers.

# Specifications: Front-Panel Jumpers

## Model N5230A Option 025, 125, 225, 425, or 525

**Note:** The N5230A Option 020, 120, 220, 420, or 520 (standard test set and standard power range) has no front-panel jumpers.

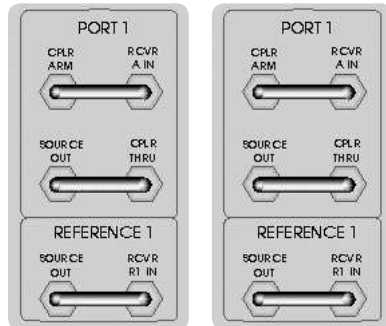

**Table 23: Measurement receiver inputs (rcvr A In, rcvr B In)  
0-1 dB Typical Compression**

| Description                | Specification | Typicals        |            |                  |
|----------------------------|---------------|-----------------|------------|------------------|
|                            |               | Option 025, 125 | Option 225 | Options 425, 525 |
| <b>Maximum input level</b> |               |                 |            |                  |
| 300 kHz to 10 MHz          |               | -11 dBm         |            |                  |
| 10 to 45 MHz               |               | -7 dBm          | -2 dBm     | -20 dBm          |
| 45 to 500 MHz              |               | -7 dBm          | -2 dBm     | -19 dBm          |
| 500 MHz to 2 GHz           |               | -6 dBm          | -3 dBm     | -14 dBm          |
| 2 to 12.5 GHz              |               | -6 dBm          | -6 dBm     | -14 dBm          |
| 12.5 to 13.5 GHz           |               | -7 dBm          | -6 dBm     | -15 dBm          |
| 13.5 to 20 GHz             |               |                 | -6 dBm     | -15 dBm          |
| 20 to 31.25 GHz            |               |                 |            | -16 dBm          |
| 31.25 to 40 GHz            |               |                 |            | -21 dBm          |
| 40 to 45 GHz               |               |                 |            | -24 dBm          |
| 45 to 50 GHz               |               |                 |            | -22 dBm          |
| <b>Damage level</b>        |               |                 |            |                  |
| N5230A                     |               | +15 dBm         | +15 dBm    | +15 dBm          |
| <b>Maximum DC level</b>    |               |                 |            |                  |
| N5230A                     |               | ±16 V           | ±7 V       | ±7 V             |

**Table 24: Reference receiver inputs (rcvr R1, rcvr R2)  
at maximum specified output power**

| Description                | Specification | Typicals        |            |                  |
|----------------------------|---------------|-----------------|------------|------------------|
|                            |               | Option 025, 125 | Option 225 | Options 425, 525 |
| <b>Maximum input level</b> |               |                 |            |                  |
| 300 kHz to 10 MHz          |               | -15 dBm         |            |                  |
| 10 to 500 MHz              |               | -13 dBm         | -18 dBm    | -28 dBm          |
| 500 to 2 MHz               |               | -14 dBm         | -18 dBm    | -28 dBm          |
| 2 to 6 GHz                 |               | -14 dBm         | -19 dBm    | -28 dBm          |
| 6 to 8 GHz                 |               | -16 dBm         | -19 dBm    | -28 dBm          |
| 8 to 9 GHz                 |               | -16 dBm         | -21 dBm    | -27 dBm          |
| 9 to 10.5 GHz              |               | -20 dBm         | -21 dBm    | -27 dBm          |
| 10.5 to 12.5 GHz           |               | -22 dBm         | -21 dBm    | -27 dBm          |
| 12.5 to 13.5 GHz           |               | -24 dBm         | -23 dBm    | -26 dBm          |
| 13.5 to 20 GHz             |               |                 | -23 dBm    | -26 dBm          |
| 20 to 31.25 GHz            |               |                 |            | -33 dBm          |
| 31.25 to 40 GHz            |               |                 |            | -27 dBm          |
| 40 to 45 GHz               |               |                 |            | -29 dBm          |
| 45 to 50 GHz               |               |                 |            | -28 dBm          |
| <b>Damage level</b>        |               |                 |            |                  |
| N5230A                     |               | +15 dBm         | +15 dBm    | +15 dBm          |
| <b>Maximum DC level</b>    |               |                 |            |                  |
| N5230A                     |               | ±16 V           | ±7 V       | ±7 V             |

**Table 25: Reference Outputs (reference 1 source out, reference 2 source out)  
at maximum specified output power**

| Description                 | Specification | Typicals        |            |                  |
|-----------------------------|---------------|-----------------|------------|------------------|
|                             |               | Option 025, 125 | Option 225 | Options 425, 525 |
| <b>Maximum output level</b> |               |                 |            |                  |
| 300 kHz to 10 MHz           |               | -15 dBm         |            |                  |
| 10 to 500 MHz               |               | -13 dBm         | -18 dBm    | -28 dBm          |
| 500 MHz to 2 GHz            |               | -14 dBm         | -18 dBm    | -28 dBm          |
| 2 to 6 GHz                  |               | -14 dBm         | -19 dBm    | -28 dBm          |
| 6 to 8 GHz                  |               | -16 dBm         | -19 dBm    | -28 dBm          |
| 8 to 9 GHz                  |               | -16 dBm         | -20 dBm    | -27 dBm          |
| 9 to 10.5 GHz               |               | -20 dBm         | -20 dBm    | -27 dBm          |
| 10.5 to 12.5 GHz            |               | -22 dBm         | -20 dBm    | -27 dBm          |
| 12.5 to 13.5 GHz            |               | -24 dBm         | -23 dBm    | -26 dBm          |
| 13.5 to 20 GHz              |               |                 | -23 dBm    | -26 dBm          |
| 20 to 31.25 GHz             |               |                 |            | -32 dBm          |
| 31.25 to 40 GHz             |               |                 |            | -26 dBm          |
| 40 to 45 GHz                |               |                 |            | -29 dBm          |
| 45 to 50 GHz                |               |                 |            | -28 dBm          |
| <b>Damage level</b>         |               |                 |            |                  |
| N5230A                      |               | +20 dBm         | +20 dBm    | +20 dBm          |
| <b>Maximum DC level</b>     |               |                 |            |                  |
| N5230A                      |               | ±16 V           | ±7 V       | ±7 V             |

**Table 26: Source outputs (port 1 source out, port 2 source out)  
at maximum specified output power**

| Description                 | Specification | Typicals        |            |                  |
|-----------------------------|---------------|-----------------|------------|------------------|
|                             |               | Option 025, 125 | Option 225 | Options 425, 525 |
| <b>Maximum output level</b> |               |                 |            |                  |
| 300 kHz to 10 MHz           |               | +11 dBm         |            |                  |
| 10 to 500 MHz               |               | +11 dBm         | +6 dBm     | +1 dBm           |
| 500 MHz to 6 GHz            |               | +11 dBm         | +7 dBm     | +1 dBm           |
| 6 to 9 GHz                  |               | +10 dBm         | +7 dBm     | +1 dBm           |
| 9 to 12.5 GHz               |               | +8 dBm          | +7 dBm     | +1 dBm           |
| 12.5 to 13.5 GHz            |               | +5 dBm          | +5 dBm     | +3 dBm           |
| 13.5 to 20 GHz              |               |                 | +5 dBm     | +3 dBm           |
| 20 to 31.25 GHz             |               |                 |            | -5 dBm           |
| 31.25 to 40 GHz             |               |                 |            | -4 dBm           |
| 40 to 45 GHz                |               |                 |            | -11 dBm          |
| 45 to 50 GHz                |               |                 |            | -11 dBm          |
| <b>Damage level</b>         |               |                 |            |                  |
| N5230A                      |               | +27 dBm         | +30 dBm    | +30 dBm          |
| <b>Maximum DC level</b>     |               |                 |            |                  |
| N5230A                      |               | ±16 V           | ±7 V       | ±7 V             |

**Table 27: Coupler inputs (port 1 Cplr Thru, port 2 Cplr Thru)**

| Description                        | Specification | Typicals        |            |                  |
|------------------------------------|---------------|-----------------|------------|------------------|
|                                    |               | Option 025, 125 | Option 225 | Options 425, 525 |
| <b>Insertion loss to test port</b> |               |                 |            |                  |
| 30 kHz to 10 MHz                   |               | 2 dB            |            |                  |
| 10 to 500 MHz                      |               | 2 dB            | 0.6 dB     | 0.6 dB           |
| 500 MHz to 2 GHz                   |               | 3 dB            | 1.6 dB     | 0.8 dB           |
| 2 to 8 GHz                         |               | 3 dB            | 1.8 dB     | 1.0 dB           |
| 8 to 9 GHz                         |               | 3 dB            | 1.9 dB     | 1.0 dB           |
| 9 to 12.5 GHz                      |               | 4 dB            | 1.9 dB     | 1.0 dB           |
| 12.5 to 13.5 GHz                   |               | 4 dB            | 2.0 dB     | 2.0 dB           |
| 13.5 to 20 GHz                     |               |                 | 2.0 dB     | 2.0 dB           |
| 20 to 31.25 GHz                    |               |                 |            | 3.0 dB           |
| 31.25 to 50 GHz                    |               |                 |            | 4.0 dB           |
| <b>Damage level</b>                |               |                 |            |                  |
| N5230A                             |               | +27 dBm         | +30 dBm    | +30 dBm          |
| <b>Maximum DC level</b>            |               |                 |            |                  |
| N5230A                             |               | ±16 V           | ±40 V      | ±40 V            |

**Table 28: Coupler outputs (port 1 Cplr Arm, port 2 Cplr Arm)**

| Description             | Specification | Typicals        |            |                  |
|-------------------------|---------------|-----------------|------------|------------------|
|                         |               | Option 025, 125 | Option 225 | Options 425, 525 |
| <b>Damage level</b>     |               |                 |            |                  |
| N5230A                  |               | +15 dBm         | +30 dBm    | +30 dBm          |
| <b>Maximum DC level</b> |               |                 |            |                  |
| N5230A                  |               | +0 Vdc          | +7 Vdc     | +7 Vdc           |

## Test Set Block Diagrams

### N5230A Option 020, 120, 220, 420, or 520

(standard test set and standard power range) network analyzer

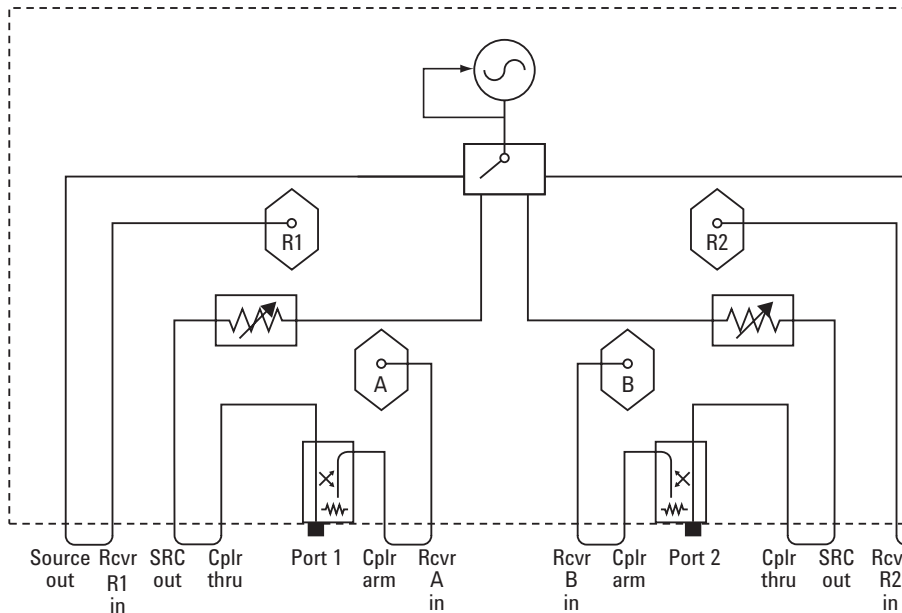

### N5230A Option 025, 125, 225, 425, or 525

(configurable test set and extended power range) network analyzer

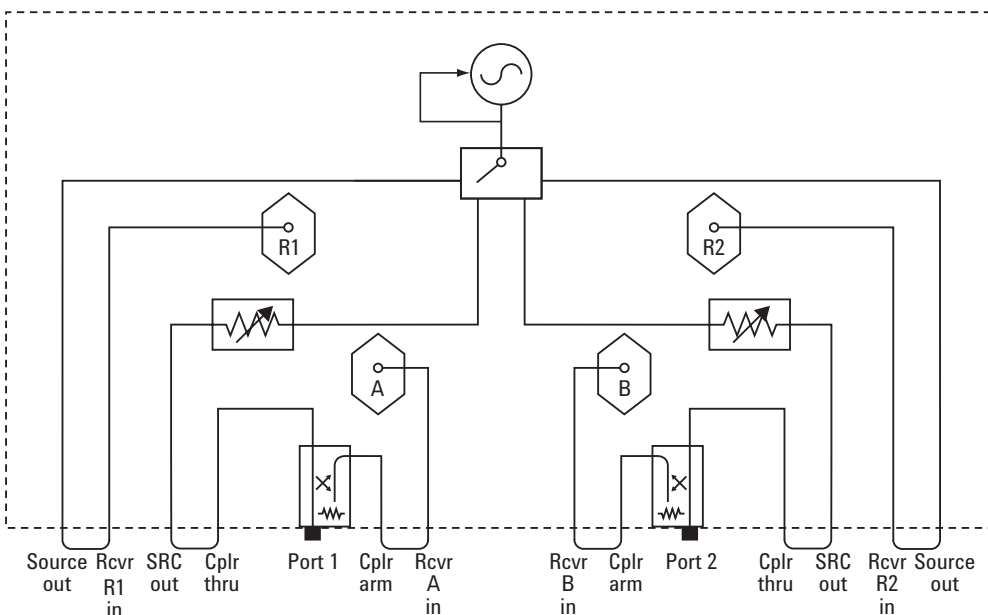

## Web Resources

Visit our Web sites for additional product information and literature.

PNA Microwave network analyzers:  
**[www.agilent.com/find/pna](http://www.agilent.com/find/pna)**

PNA-L network analyzers:  
**[www.agilent.com/find/pnal](http://www.agilent.com/find/pnal)**

Electronic calibration (ECal):  
**[www.agilent.com/find/ecal](http://www.agilent.com/find/ecal)**

Test and measurement solutions:  
**[www.agilent.com/find/accessories](http://www.agilent.com/find/accessories)**



### Agilent Email Updates

[www.agilent.com/find/emailupdates](http://www.agilent.com/find/emailupdates)

Get the latest information on the products and applications you select.



[www.axistandard.org](http://www.axistandard.org) AdvancedTCA<sup>®</sup> Extensions for Instrumentation and Test (AXIe) is

an open standard that extends the AdvancedTCA for general purpose and semiconductor test. Agilent is a founding member of the AXIe consortium.



[www.lxistandard.org](http://www.lxistandard.org)

LAN eXtensions for Instruments puts the power of Ethernet and the Web inside your test systems. Agilent is a founding member of the LXI consortium.



[www.pxisa.org](http://www.pxisa.org)

PCI eXtensions for Instrumentation (PXI) modular instrumentation delivers a rugged, PC-based high-performance measurement and automation system.

### Agilent Channel Partners

[www.agilent.com/find/channelpartners](http://www.agilent.com/find/channelpartners)

Get the best of both worlds: Agilent's measurement expertise and product breadth, combined with channel partner convenience.



Agilent Advantage Services is committed to your success throughout your equipment's lifetime. To keep you competitive, we continually invest in tools and processes that speed up calibration and repair and reduce your cost of ownership. You can also use Infoline Web Services to manage equipment and services more effectively. By sharing our measurement and service expertise, we help you create the products that change our world.

[www.agilent.com/find/advantageservices](http://www.agilent.com/find/advantageservices)



[www.agilent.com](http://www.agilent.com)  
[www.agilent.com/find/pnal](http://www.agilent.com/find/pnal)

For more information on Agilent Technologies' products, applications or services, please contact your local Agilent office. The complete list is available at:

[www.agilent.com/find/contactus](http://www.agilent.com/find/contactus)

#### Americas

|               |                |
|---------------|----------------|
| Canada        | (877) 894 4414 |
| Brazil        | (11) 4197 3500 |
| Mexico        | 01800 5064 800 |
| United States | (800) 829 4444 |

#### Asia Pacific

|                    |                |
|--------------------|----------------|
| Australia          | 1 800 629 485  |
| China              | 800 810 0189   |
| Hong Kong          | 800 938 693    |
| India              | 1 800 112 929  |
| Japan              | 0120 (421) 345 |
| Korea              | 080 769 0800   |
| Malaysia           | 1 800 888 848  |
| Singapore          | 1 800 375 8100 |
| Taiwan             | 0800 047 866   |
| Other AP Countries | (65) 375 8100  |

#### Europe & Middle East

|                |                                  |
|----------------|----------------------------------|
| Belgium        | 32 (0) 2 404 93 40               |
| Denmark        | 45 70 13 15 15                   |
| Finland        | 358 (0) 10 855 2100              |
| France         | 0825 010 700*<br>*0.125 €/minute |
| Germany        | 49 (0) 7031 464 6333             |
| Ireland        | 1890 924 204                     |
| Israel         | 972-3-9288-504/544               |
| Italy          | 39 02 92 60 8484                 |
| Netherlands    | 31 (0) 20 547 2111               |
| Spain          | 34 (91) 631 3300                 |
| Sweden         | 0200-88 22 55                    |
| United Kingdom | 44 (0) 131 452 0200              |

For other unlisted countries:

[www.agilent.com/find/contactus](http://www.agilent.com/find/contactus)

Revised: June 8, 2011

Product specifications and descriptions in this document subject to change without notice.

© Agilent Technologies, Inc. 2008, 2009, 2011

Published in USA, October 12, 2011  
5989-0514EN

Intel<sup>®</sup> and Pentium<sup>®</sup> are US registered trademarks of Intel Corporation.

